



# BALANCED PRESSURE THERMOSTATIC STEAM TRAPS



# X-ELEMENT

## Unique "fail open"

### Design matches needs

TLV "L-Series" Traps are manufactured with high quality to ensure excellent performance and life. Even so, failure of any mechanical device is inevitable and the consequences can be severe. A steam trap can either:

- \*"Fail open", causing much energy loss.
- \*"Fail closed", thereby accumulating condensate.

Failing closed can allow condensate back-up into the steam main where it is carried downstream with severe consequences such as water hammer. Also, a similarly dangerous situation exists when a trap fails closed on steam tracing, because the failure can cause the product to gel or even become permanently solidified in the line. TLV's "L-Series" thermostatic traps, with a unique nickel based alloy steel diaphragm "X-element" are designed to "fail open" and protect against unwanted condensate accumulation.

### Valve shape supports diaphragm

The valve has been designed to match the diaphragm contour. This provides the diaphragms with excellent support when internal pressure pushes them against the valve, and subsequently the danger of deformation or element rupturing is virtually eliminated.

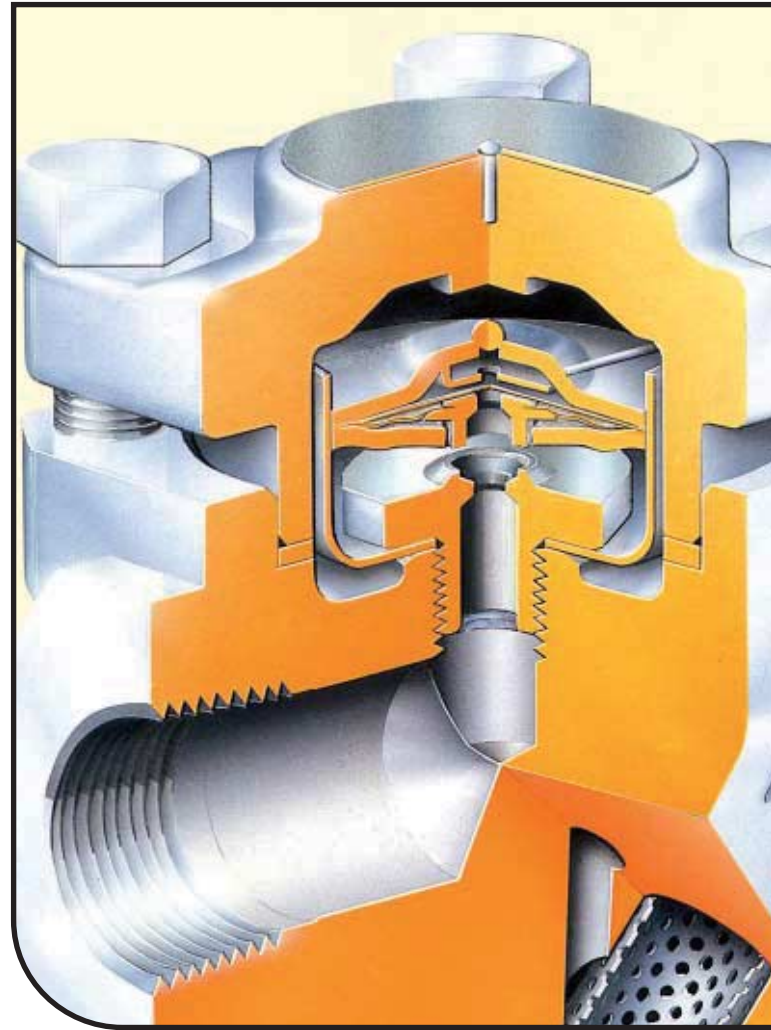

## FAIL OPEN VS. FAIL CLOSED

### "Which type is better?"

The thin diaphragm is the most delicate part of a thermostatic capsule. "Fail open" means that, except for plugging, the valve will fail open even if the diaphragm(s) break. "Fail closed" means that, while the trap may leak when failed, it also has a significant tendency to close tightly once failed. When a trap has "failed closed", condensate accumulates and can cause:

1. Water hammer
2. Low process temperatures
3. Solidification of the product in the traced line

... the "fail open" feature reduces the danger of production or operation losses and provides for a safer working environment.

### "Fail closed" elements have only two diaphragms, or can be bellows type:

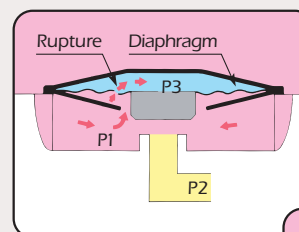

1. When the diaphragm attached to the valve head breaks, its liquid fill escapes. This allows the primary pressure, P1 to build up in the chamber above the diaphragm.

2. The internal chamber pressure, P3, equalizes with the incoming P1 and closes the valve. System drainage ceases.

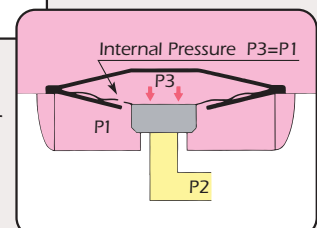

# "Open" capsule resists water hammer and superheat.

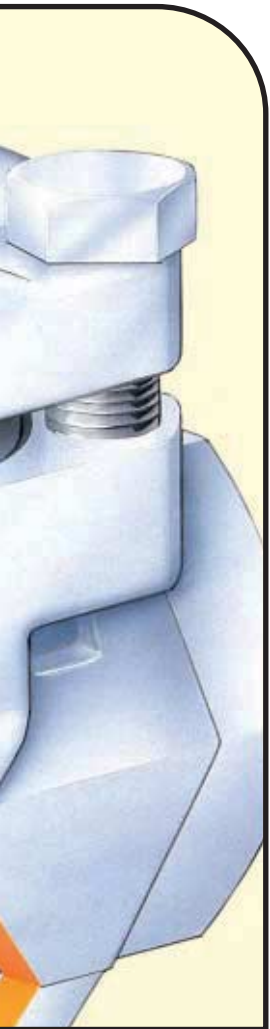

## Case supports diaphragms

The protective case design is perfectly contoured to match the shape of the two lower diaphragms. Therefore, even if subjected to water hammer or excessive internal superheat pressure, the diaphragms are well protected from damage.



## Safety - "fail open" feature

The unique configuration of multiple diaphragms and a valve head with a center hole guarantees a "fail open" position should any valve part fail. Condensate will be discharged even in the event of damage to the X-element itself. Consequently, the process will not be disturbed or interrupted, nor will there be any danger of water hammer due to condensate back-up.



## Inline repairable

Inline maintenance of valve and strainer is easy with L-Series steam traps. Simply remove the cover and clip for valve access, or the strainer for cleaning.



## TLV's "fail open" "X-element" When the Upper Diaphragm is Ruptured

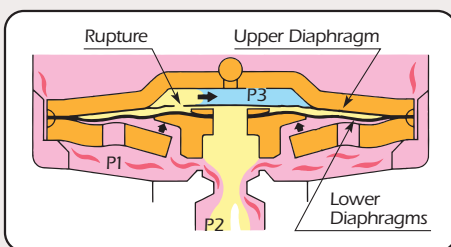

The internal chamber pressure "P3", equalizes with the downstream pressure, "P2". This causes the lower diaphragms and attached valve head to be lifted by the primary pressure, "P1", which opens the valve.

The valve remains raised and the trap is "FAIL OPEN" as long as the primary pressure is maintained.

## When the Lower Diaphragms are Ruptured

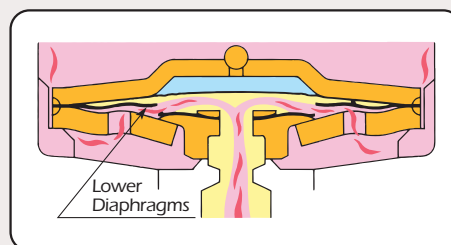

When the lower diaphragms suffer only a slight tear and the valve head is intact, the trap may leak, but it can still discharge condensate at the maximum discharge rate.

If the valve head (completely severed from the lower diaphragms) was fully seated, the condensate rate would drain through its center hole at approximately 60% of the trap's discharge rate.

# capsule resists water hammer and superheat.



The "X-element" internal chamber contains a liquid fill whose saturation temperature is slightly lower than the saturation temperature of water. With rising condensate temperature reaching the trap, the fill evaporates and its resulting internal pressure expands the diaphragms to close the valve. When the condensate temperature cools, the fill condenses and its resulting pressure reduces allowing the diaphragms to contract for the valve to open.

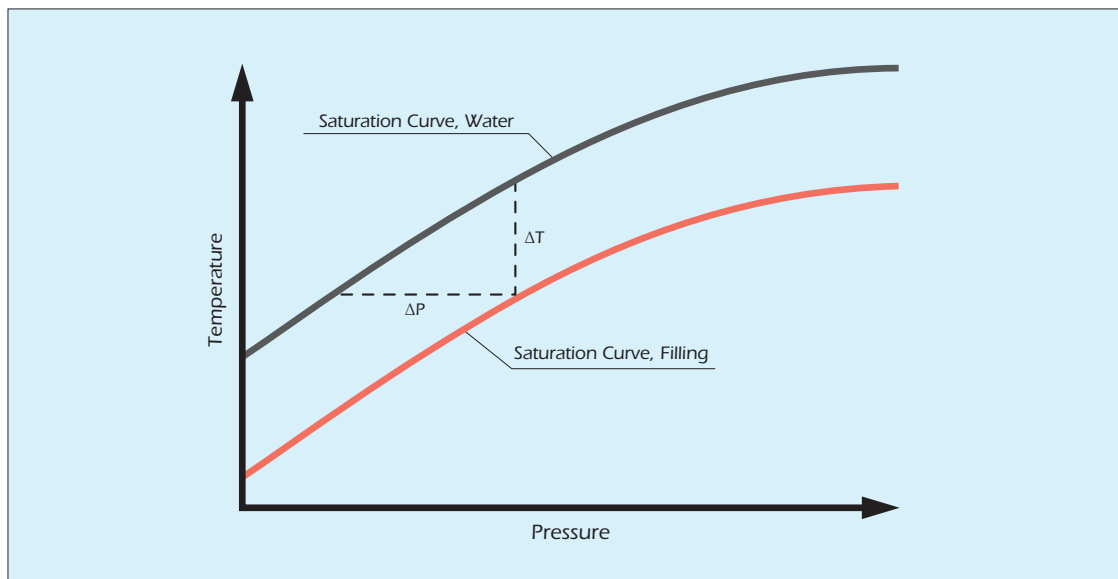

## VALVE OPEN

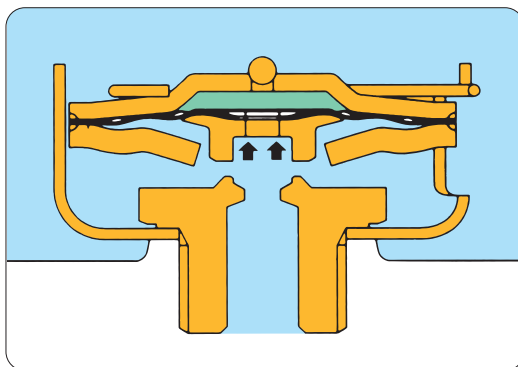

During start-up of steam using equipment, steam mains, or tracers, the fill is in the liquid state while the capsule is still cold. While the fill is liquid, the internal chamber pressure is lower than the external primary pressure. This difference allows the diaphragms to be raised by the external pressure and open the valve so that air, other incondensibles and condensate can be discharged.

## VALVE CLOSED

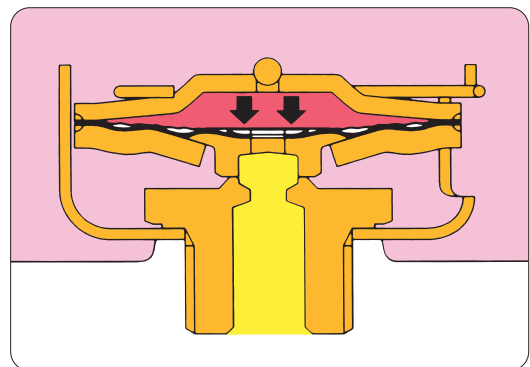

High condensate temperature evaporates the "X-element" fill and increases the internal chamber pressure to expand the diaphragms.

- The valve closes.

As the condensate temperature surrounding the element drops due to radiation heat loss, the vaporized fill cools and condenses lowering the internal chamber pressure. The diaphragms can then be lifted by the higher external pressure.

- The valve opens and discharges again.
- This operation repeats cyclically.



## Specifications



L21S/L32S

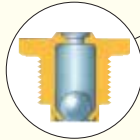
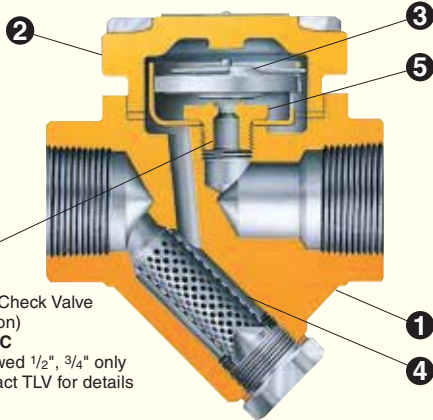

With Check Valve  
(Option)  
L32SC  
Screwed 1/2", 3/4" only  
Contact TLV for details



FL21/FL32

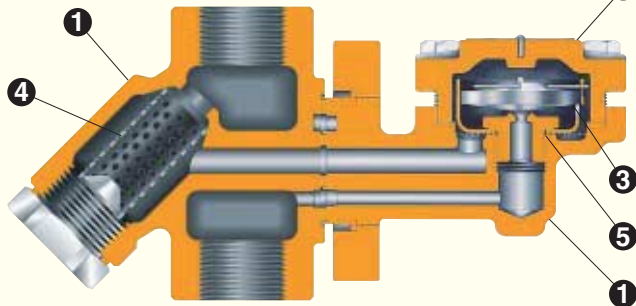

LV21

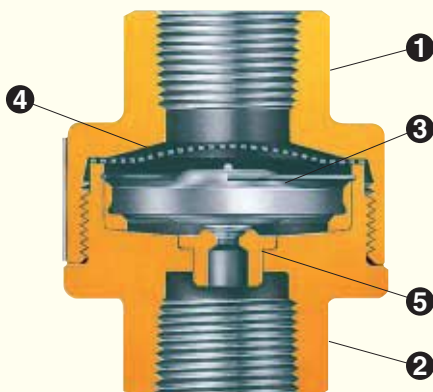

Model	Size (inch)	Max. Oper. Press. (psig) PMO	Max. Oper. Press. (°F) TMO	Max. Allow. Press. (psig) PMA	Conn.
L21S	1/2, 3/4, 1	300	See graph below	450 at 572 °F	NPT SW Flgd
L32S		450			
FL21		300			
FL32		450			
LV21	1/4, 3/8, 1/2, 3/4	300		900 at 800 °F	NPT

Maximum Operating/  
Allowable Temperature (°F) TMO/TMA

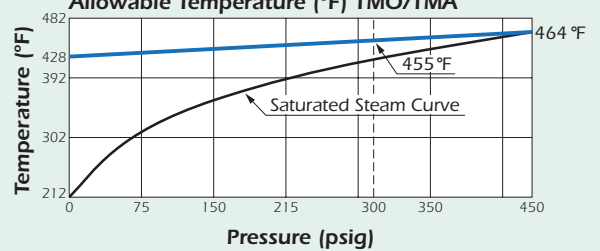

No.	Description	Material		
		L21S L32S	FL21 FL32	LV21
1	Body	Carbon Steel Stainless Steel	Stainless Steel	
2	Cover	Carbon Steel Stainless Steel	Carbon Steel	Stainless Steel
3	X-element	Stainless Steel		
4	Screen	Stainless Steel		
5	Valve Seat	Stainless Steel		

## Discharge Capacity

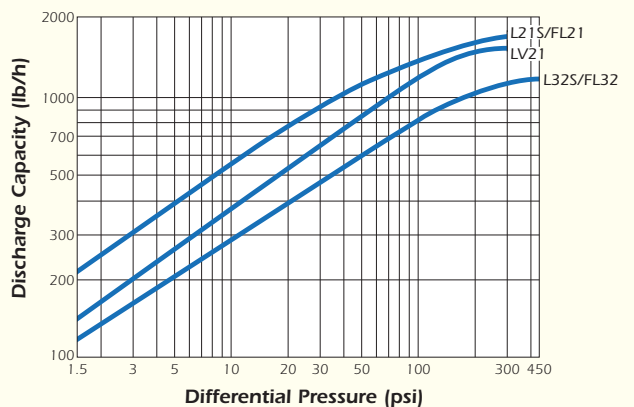

1. Differential pressure is the difference between the inlet and outlet pressure of the trap.
2. Recommended safety factor: 2.



To avoid abnormal operation, accidents or serious injury, DO NOT use this product outside of the specification range. Local regulations may restrict the use of this product to below the conditions quoted.

# "X-element" versus Bellows Type

## "X-ELEMENT"

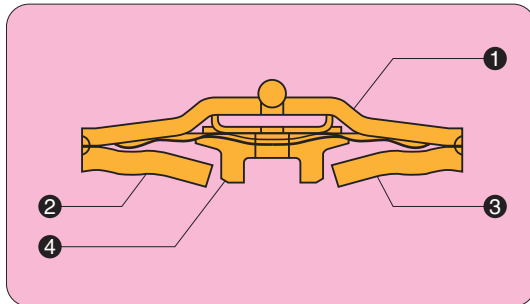

- ① Welded, heavy duty all stainless steel case resists water hammer.
- ② Case withstands excessive internal pressure generated by surges or superheat.
- ③ Matching contour of case supports diaphragms and prevents deformation, even under severe pressure.
- ④ Shape of valve seat protects diaphragms from shock and supports them to prevent deformation from superheat and water hammer.

## BELLOWS

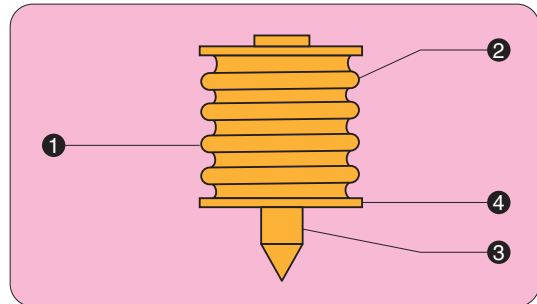

- ① Thin-walled element has no protective case to resist water hammer.
- ② No external case promotes element rupture under superheat, and deforms when subjected to shock.
- ③ Bellows units can fail either open or closed, without consistency.
- ④ Bellows can be made of welded stainless, but are often just of soldered bronze or monel manufacture.

## "L-SERIES" BALANCED PRESSURE THERMOSTATIC STEAM TRAPS SUMMARY

Maintainable steel-bodied, thermostatic traps with high air venting capability and light to medium condensate capacity for steam mains, tracing and process equipment.

1. Patented "fail open" design for critical service performance.
2. Hardened stainless steel valve head and seat for maximum life.
3. Positive open-close operation reduces valve wear.
4. "Pressure-to-close" valve design increases longevity.
5. Valve, four diaphragms and casing have matching contours for high superheat capability and water hammer resistance.
6. Large screen area promotes trouble-free service.
7. Self-draining for freeze protection in vertical installations.
8. Flat mirror-finish valve head provides tightest sealing for energy efficiency and life.
9. Compact and capable of self-adjusting to wide flow variations.
10. Cleanable and repairable design lowers maintenance costs.



**CAUTION** DO NOT DISASSEMBLE OR REMOVE THIS PRODUCT WHILE IT IS UNDER PRESSURE. Allow internal pressure of this product to equal atmospheric pressure and its surface to cool to room temperature before disassembling or removing. Failure to do so could cause burns other injury. READ INSTRUCTION MANUAL CAREFULLY.

## TLV CORPORATION

13901 South Lakes Drive, Charlotte, NC 28273-6790  
 Tel: 704-597-9070 Fax: 704-583-1610  
 E-mail: [tlv@tlvengineering.com](mailto:tlv@tlvengineering.com) <http://www.tlv.com>  
 For Technical Service 1-800 "TLV TRAP"



Manufacturer  
**TLV CO., LTD.**  
 Kakogawa, Japan  
 is approved by LRQA Ltd. to ISO 9001/14001

