



VACUUMIZER®

MODEL VM-H

LOW-TEMPERATURE VACUUM STEAM HEATING SYSTEM

Benefits

Provide rapid start-up, uniform heating and accurate control of jacketed vessels and conical or cylinder dryers.

1. Steam temperature control of ± 1.8 °F ensures consistent production quality.
2. Delivers heating temperature as low as 86 °F to improve manufactured quality of temperature sensitive products.
3. Using the latent heat and “U” value of steam significantly increases production capability over hot water heating alternatives.
4. Package models facilitate piping installation.



Specifications of Vacuum Heating System

Vacuum Steam Temperature Range	86* to 230 °F (over 212 °F is positive pressure steam)
Vacuum Steam Temperature Stability	Set temperature ± 1.8 °F

* If make up water temperature is 41 °F or higher, minimum steam temperature is make up water temperature + 45 °F



To avoid abnormal operation, accidents or serious injury, DO NOT use this product outside of the specification range. Local regulations may restrict the use of this product to below the conditions quoted.

Product Series

Type (Model)	Usage	Features
Package Type 	Production process and pilot plant • Applications: • Jacket reacting tank (Capacity: up to 2640 gal) • Shell and tube type heat exchanger, Hot air dryer, Roll heater, etc. * Maximum possible heat energy supplied is 1,177,000 BTU/h.	• Since package includes all necessary equipment, piping installation is easy • Moves easily on casters (option)
Engineering Type	Production process • Applications: • Jacket reacting tank, Shell and tube type heat exchanger • Roll heater, etc.	• System can be designed flexibly according to required specifications

Package Types

● **Specifications**

Model	VM3HP-25	VM3HP-40	VM3HP-50
Supply Steam Inlet Pressure (psig)	15 - 30		
Vacuum Steam Capacity (lb/h) (Maximum Heating Energy (×10 ³ BTU/h))	330 (290)	860 (768)	1320 (1177)
Vacuum Generated Steam	Condensate Load (lb/h)		
	1300		
	Exhaust Speed (scfm)		
6.4			
Motor Power			1 hp
Power Supply	230 V AC (60 Hz) three-phase		
Safety Specification (Motor, Control Valve, Sensor)	Non-explosion proof (Consult TLV for explosion proof type)		
Location for Installation	Indoor or outdoor		
Material*	Control Valve		
	Cast iron A126 Cl.B		
	Vacuum Generation Unit (Wetted Portions)		
	Pump: Cast iron A48 Tank: Carbon steel A53 Ejector: Cast iron A126 Cl.B Nozzle/Diffuser: Stainless steel AISI304		
Connection	Steam Piping Unit		
	Carbon steel A53 TYPE S		
	Casing		
	Steel plate A109		
	Steam Inlet/Outlet		
2" ASME Class 150 RF			
Steam Condensate Inlet			
2" ASME Class 150 RF			
Overflow Connection			
Make Up Water Inlet			
Screwed 1/2" NPT			
Tank Condensate Blow Connection			
Screwed 1/2" NPT			
External Dimensions (Width × Depth × Height)	25 ⁵ / ₈ " × 39 ³ / ₈ " × 56 ⁵ / ₁₆ "		
Weight	Approx. 790 lb	Approx. 840 lb	Approx. 880 lb
Control Panel	Refer to standard control panel specifications		

* ASTM/AISI materials shown are equivalent materials

● **Vacuum Steam & Heating Energy**

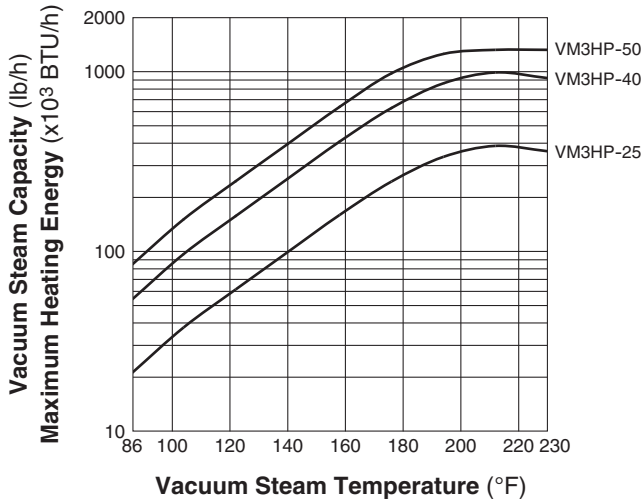

● **Piping Example**

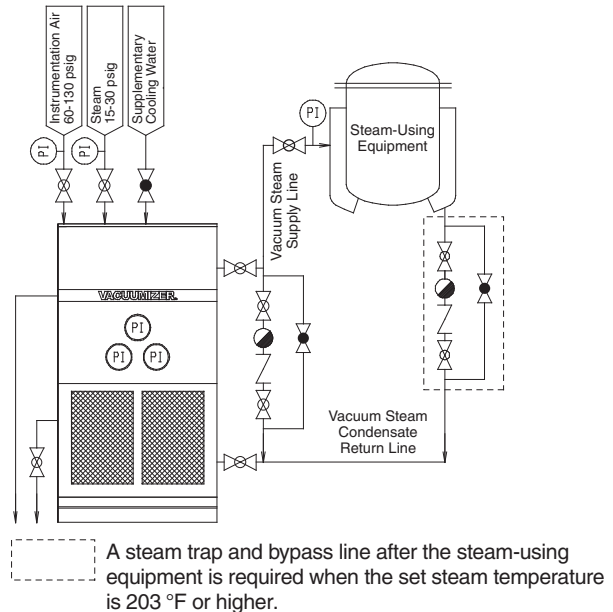

● **Options**

Condensate Discharge Function for Recovery	Discharge Valve Outlet: 1/2" Screwed (NPT) Discharge Pressure: Approx. 22 psig Maximum Discharge Capacity: Approx. 2200 lb/h
Configuration of the Base	Equipped with Casters
Material	Stainless Steel for Wetted Portions (Pump, Tank, Ejector, etc.)
High Temperature Model	Vacuum Steam Temperature Range: 86* to 302 °F (Over 212 °F is Positive Pressure Steam)

* If make up water temperature is 41 °F or higher, minimum steam temperature is make up water temperature +45 °F

Engineering Type

• Standard System Components

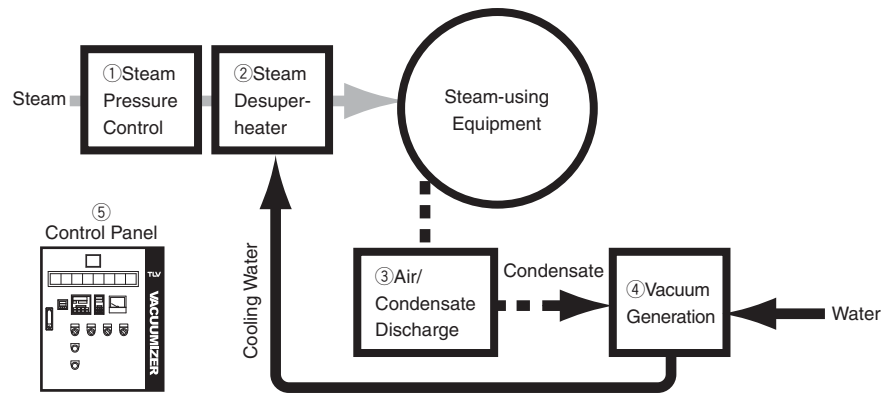

①	Steam Pressure Control	Reduces the pressure of positive pressure steam supplied from the boiler to the saturated steam pressure (below atmospheric) of the set steam temperature
②	Steam Desuperheater	Changes superheated steam to stable low temperature saturated steam
③	Air/Condensate Discharge*	Discharges initial air from the steam-using equipment, and discharges condensate from the equipment during heating
④	Vacuum Generation	Discharges air when the process starts up, discharges condensate from the equipment during heating, and controls the set level of vacuum
⑤	Control Panel	Controls the system

* Steam trap and bypass valve set, required when steam supply temperature is over 203 °F

• Vacuum Generation Unit Specifications

Model	VG3	VG4	
Motor Power	1 hp	2 hp	
Safety Specification (Motor & Other Electric Equipment)	Non-explosion proof (Consult TLV for explosion proof type)	Non-explosion proof (Consult TLV for explosion proof type)	
Process Fluid	Air, Steam (Steam Condensate), Water		
Condensate Load	1300 lb/h	3300 lb/h	
Exhaust Speed	6.4 scfm	12.7 scfm	
Lowest Attainable Pressure	Saturation pressure of the motive water (at corresponding temperature)		
Connection:	Steam Condensate Inlet	2" ASME Class 150 RF	3" ASME Class 150 RF
	Overflow Connection		
Connection:	Make Up Water Inlet	1/2" NPT	3/4" NPT
	Condensate Discharge Connection*	3/4" NPT	1" NPT
	Tank Condensate Blow Connection	1/2" NPT	
Material	Stainless steel equivalent to AISI304		
Control	Tank water automatic priming Automatic control of tank water temperature		

* Condensate discharge function is optional

• External Dimensions of Vacuum Generation Unit

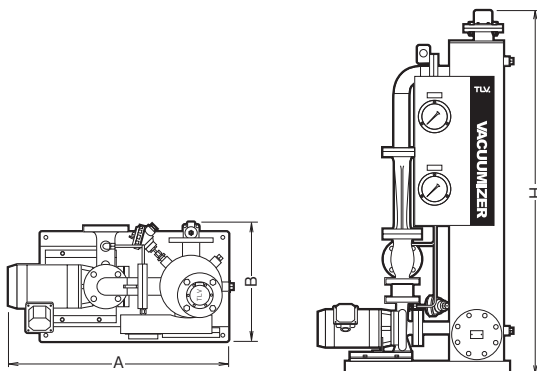

Model	Unit: inch			
	A	B	H	Weight (lb)
VG3	31 1/2	15 3/4	57	285
VG4	38 5/16	19 3/4	60	410

All dimensions are approximate

Engineering Type

• Vacuum Pressure Control Valve Size & Vacuum Steam Capacity

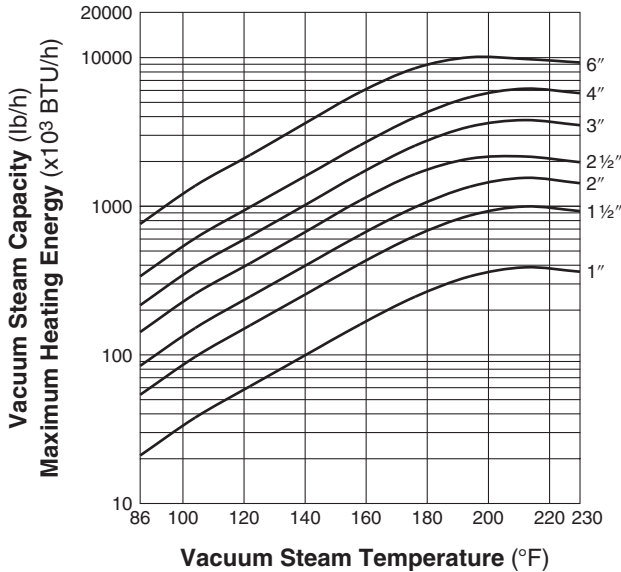

Select the size for the vacuum pressure reducing valve using the table left after determining the temperature of the steam used and maximum required heating energy.

• Options

Material	Non stainless steel parts: Pump (cast iron), ejector (cast iron), others (carbon steel)
Condensate Discharge Function for Recovery	<ul style="list-style-type: none"> • Detect the water level in the tank of the vacuum generation unit and pump condensate by opening and closing the discharge valve automatically • Discharge pressure: Approx. 22 psig • Maximum discharge capacity: VG3: 2200 lb/h, VG4: 5500 lb/h

Standard Control Panel (VM3HP & Engineering Type)

• Specifications

Basic Functions	<ul style="list-style-type: none"> • Tank water: Automatic priming, pump auto-start • Tank water temperature: Automated control • Steam temperature: Automated control • Start/Stop: External signal input • Start/Stop/Overload: External signal output
Selected Function	<ul style="list-style-type: none"> • Steam temperature remote setting (Programmed in memory)
Power Supply Voltage	<ul style="list-style-type: none"> • Motor: 230 V AC 3-phase • Instrumentation: 24 V DC
Installation	Indoor wall mounted

Note: Control panel design is non-explosion proof. Consult TLV for explosion proof type. Non-standard specifications are also available, contact TLV for details.

• Dimensions

Unit: inch

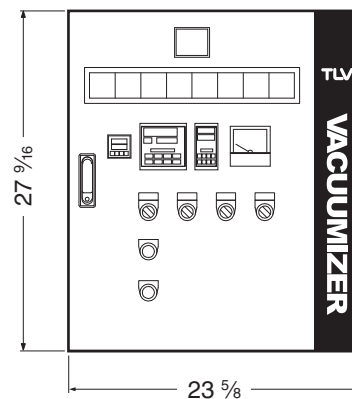

TLV CORPORATION

13901 South Lakes Drive, Charlotte, NC 28273-6790
 Phone: 704-597-9070 Fax: 704-583-1610
 E-mail: tlv@tlvengineering.com
 For Technical Service 1-800 "TLV TRAP"



Manufacturer
TLV CO., LTD.
 Kakogawa, Japan
 is approved by LRQA Ltd. to ISO 9001/14001

ISO 9001/ISO 14001

