



bürkert
FLUID CONTROL SYSTEMS



bürkert
FLUID CONTROL SYSTEMS

Product Overview Pneumatics & Process Interfaces

Bürkert Fluid Control Systems
Christian-Bürkert-Straße 13-17
74653 Ingelfingen
Germany
Tel. +49 7940 100
Fax +49 7940 1091204
info@burkert.com
www.burkert.com

- 01 SOLENOID VALVES
- 02 PROCESS VALVES
- 03**
- 04 MEASUREMENT DEVICES
- 05 MICROFLUIDICS
- 06 MASS FLOW CONTROLLERS
- 07 PROPORTIONAL VALVES

Content

3	Introduction
4	Fascination Bürkert
6	Process Actuation
8	Product Overview Pneumatic
12	Seat Valve for Pneumatic Systems – Type 6014
14	Robust Single Valves – Types 6518/6519
16	Pilot Valve – Type 6144
18	Pneumatic Valves – Types 6524-6527
20	Valve Island - Type 8647
22	Valve Island - Type 8652
24	Valve Island - Type 8653
26	Valve Block – Type 8640
28	Valve Island – Type 8640
30	Process Control Centers AirLINE – Type 8644
32	Automation System AirLINE Ex – Type 8650
34	Cabinet Know-how
36	AirLINE Quick
38	ELEMENT Interface
40	Process Reliability Functions
42	Selection Criteria for Multi-Way Valves
46	Certifications
48	EDIP - The flexible solution for efficient processes
50	Accessories
52	System Solutions
56	Bürkert worldwide

The Process Interface Market Leader

Across thousands of individual solutions and spanning dynamic conditions of global competition our mission is to work towards your success.

We have decades of global experience and we have always been positioned at the forefront of pneumatic and process interface technology.

Our innovative approach to your success is to secure your process efficiency, lower your downtime, increase your safety and boost your competitive advantage.

We intend to collaborate with you where we can share our pneumatic and process interface experience.

All of our combined knowledge is available to you through consultation, engineering support, selection and commissioning.

Everyone in our organisation is interested in listening to you with the aim of presenting you with only the most appropriate solution, fluently in your daily application language.

Welcome to the Fascinating World of Fluid Control Systems

Measurement and control: When it comes to working with fluids and gases, we are at your side – as a manufacturer of sophisticated products, as a problem-solver with an eye for the big picture, and as a partner offering you reliable advice. Since we started in 1946, we have developed into one of the world's leading suppliers of Fluid Control Systems. At the same time we have kept our status as a family-owned business with a foundation of strong basic values to highlight the way we think and act.

EXPERIENCE

There are things which are not inherently yours. You have to gather them bit by bit. You receive them from others. And you constantly have to acquire them anew. That is what makes them so valuable. Experience is one of those things. For instance, because of our many years of experience with Pneumatics, we can provide our extensive services to you – from consulting, development, and 3D CAD simulating to testing and after-sales service. Whether individual product solutions or a pioneering new system for the entire control process: Benefit from our experience.

COURAGE

Those who only work toward optimizing things that already exist will eventually reach the limits – technically, financially, or personally. In order to overcome these limits, courage is needed: the courage to be different and trust one's own ideas; the courage to venture into the unknown, searching for new ways to develop products that have never existed before. We have this courage. By pooling and utilizing our competencies across all sectors, you benefit from our cumulative knowledge of Pneumatics and Process Interfaces.

CLOSENESS

There are things we simply take for granted. Only when they are gone, do we realize how important these things really were. This applies in particular to closeness. Without closeness, it is very difficult to build relationships and a good understanding of one another. As an established medium-sized company, we know that. And that is why we are always there for you. Working with you, we develop the best possible solutions for your projects in the area of Pneumatics. Our global presence in 35 locations enables us to press ahead with technical innovations for our customers around the world.

Bürkert Product Program

We are one of the few suppliers on the market to cover the complete control loop. Our current product range extends from solenoid valves through process and analytical valves to pneumatic actuators and sensors.

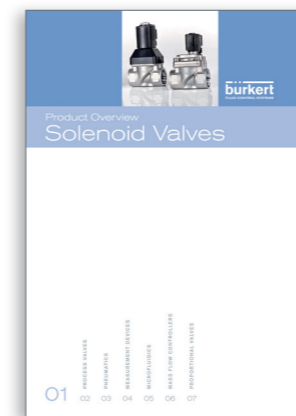

Bürkert offers a remarkable range of servo-assisted and direct acting solenoid valves. Read more about them in this brochure.

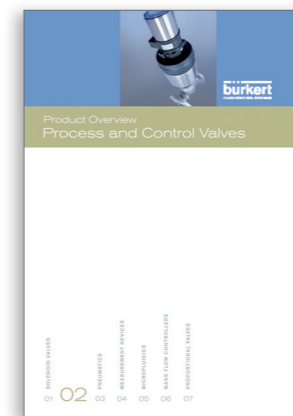

Bürkert offers unlimited modularity for process control with angle-seat, globe and diaphragm valves in the widest range of configurations.



Here you can find our product range of pneumatic valves, valve units and automation systems as well as information on our control cabinet building.



Here you can find our sensors, transmitters and controllers for measuring and controlling flow, temperature, pressure, level, pH/ORP and conductivity.



The brochure contains an overview of Bürkert miniature valves and micro pumps, which allow for precise and safe handling of small volumes of liquids.

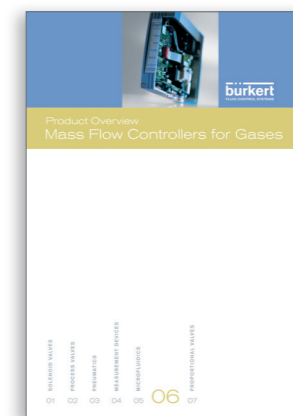

This brochure provides technical background information as well as a detailed product overview for the mass flow controller and meter product range.

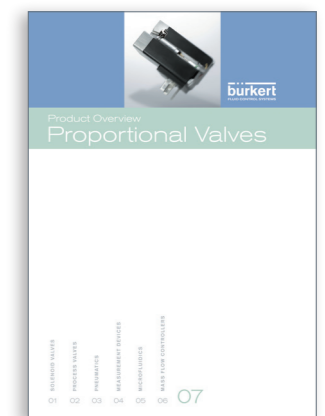

This brochure presents our solenoid control valves including their respective features, functions and typical applications.





Process Actuation

Pneumatic technology is known for high reliability, high force and torque generation and cleanliness. This makes it indispensable for efficient solutions for drives and actuators for control and regulation.

Bürkert has tamed the power of pneumatics and brings it to you in its most efficient form resulting in new standards in factory automation and process control.

Factory Automation

Factory automation refers to computer-aided automation of production in all technical and organizational areas of a factory. One special point of emphasis relates to automatic assembly of subassemblies and devices. This primarily requires transport systems, material flow systems, handling systems, robot systems and measuring systems which are connected with computer assistance. In many cases, pneumatically operated actuators are used for this (e. g. cylinders). These systems must smoothly interwork at high speed in the production process.

Process Control and Supervision

Bürkert has perfected practically-oriented pneumatics in an extremely wide variety of industries. Food, chemical and pharmaceutical industries, with their complex installations, require a high level of decentralization and conversion or expansion during operation.

Centralized or distributed control: not a question of faith in automation. Every problem is different and requires the most efficient solution. Our solutions allow you to focus on optimum process reliability, efficiency and economy.

Process Actuation and Valve Islands

The pilot valves required for controlling actuators may be fitted at various locations (Non-Ex or hazardous locations) and in different ways (centralized or decentralized automation). Our range extends from directly mounted pilot valves on the actuator to centralized valve islands with Fieldbus interface in control cabinets (AirLINE and AirLINE Ex).

When using a centralized valve island, corresponding pneumatic tubing must be installed from the control cabinet to the final control element. Alternatively, Bürkert offers with the ELEMENT positioners and controllers a wide range of equipment to actuate, monitor, network, position and decentralize process control into the field.

 <p>8647 8652 8653 8640 AirLINE Quick 8640 AirLINE Quick 8644 8644 Rockwell 8644 Phoenix 8644 Wago</p> <p>Page 20-25 Page 26 Page 36 Page 30</p>	 <p>8650</p> <p>Page 32</p>	<p>Automation systems & Valve Islands</p>
 <p>8640 with 5470 valves 8640 with 6518/6519 valves 8640 with 6526/6527 valves</p> <p>Page 26</p>	 <p>8640 with 6524/6525 Ex-i valves</p> <p>Page 26</p>	<p>Valve Blocks</p>
 <p>6144 6012P 6014P 5470 NAMUR 6518/6519 6519 extended temperatures 6524/6525 6526/6527</p> <p>Page 12-19</p>	 <p>6519 NAMUR Ex 6524 Ex-i</p> <p>Page 12-19</p>	<p>Single Pilot Valves</p>
<p>Non-Ex</p>	<p>Hazardous Locations</p>	

 <p>Control cabinets for Non-Ex locations</p> <p>Page 34</p>	 <p>ELEMENT interface</p> <p>Page 38</p>	<p>Decentralized Automation</p>
	 <p>Control cabinets for hazardous locations</p> <p>Page 34</p>	<p>Control Cabinets</p>

Central or Decentral ... You Choose.

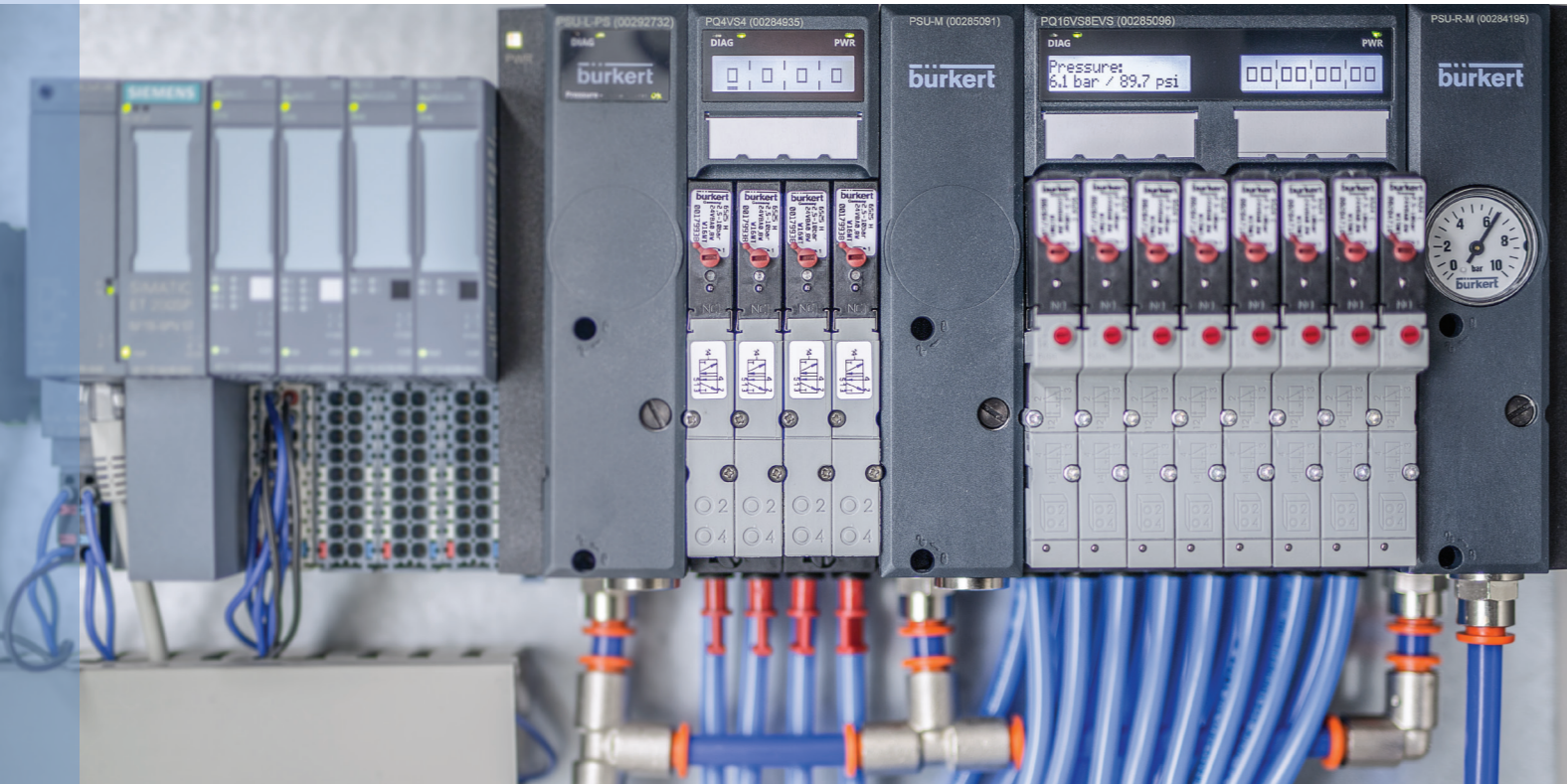

Central automation

Types 8640, 8647, 8644, 8650, 8652, 8653 in control cabinets

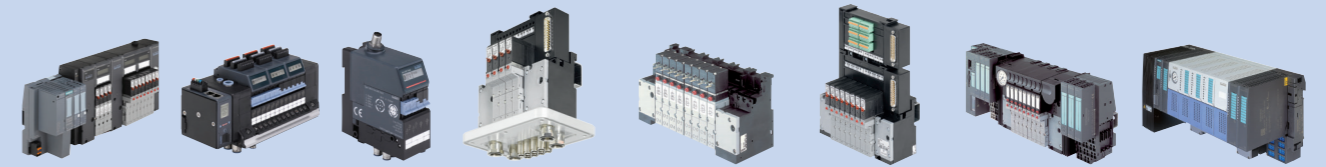

AirLINE valve blocks, valve terminals and automation systems are installed in a control cabinet in a central automation system. AirLINE is mounted inside the control cabinet either by means of a DIN-rail or in the AirLINE Quick version di-

rectly on the floor or wall of the control cabinet. The control cabinet complies with the required protection class and, if needed, also with the certification for explosive areas.



Decentral automation

Types 8690, 8697, 8695, 8691 for integrated mounting on On/Off process valves



The hygienic design of the ELEMENT devices has been optimized for process technology in the food and beverage, dairy, brewing, cosmetics and pharmaceutical industries. The product series enables robust integration of controllers, posi-

Types 8696, 8694, 8692, 8693 for integrated mounting on process control valves



tioners and process controllers while offering reliable and permanent IP protection for use in hygienic and wet areas.

Seat Valve for Pneumatic Systems – Type 6014

The ports of a seat valve are connected or disconnected by lowering or lifting a sealing element (e. g. servopiston). These seals are hermetically tight and self-readjusting, they operate without friction (no stick-slip effect) and are rarely subject to any dynamic stress. Seat valves are designed to be very tight over their entire service life and the switching travels are small. The actuating forces are pressure-dependent and relatively high; a pressure differential across the pilot valve is required for switching.

Multi-way seat valves are available with a choice of connection thread for direct installation or flange design for mounting directly on manifolds or actuators. Seat valves of narrow design are – similar to spool valves – well-suited for block assembly. Several valves may be arranged in a space-saving manner on manifolds or valve blocks with fieldbus interface. Mufflers can be connected to reduce venting noise.

The illustrations on the opposite page show a 3/2-way seat valve using the plunger principle. This type of valve has three ports and two valve seats, which open and close alternatively.



Type 6014

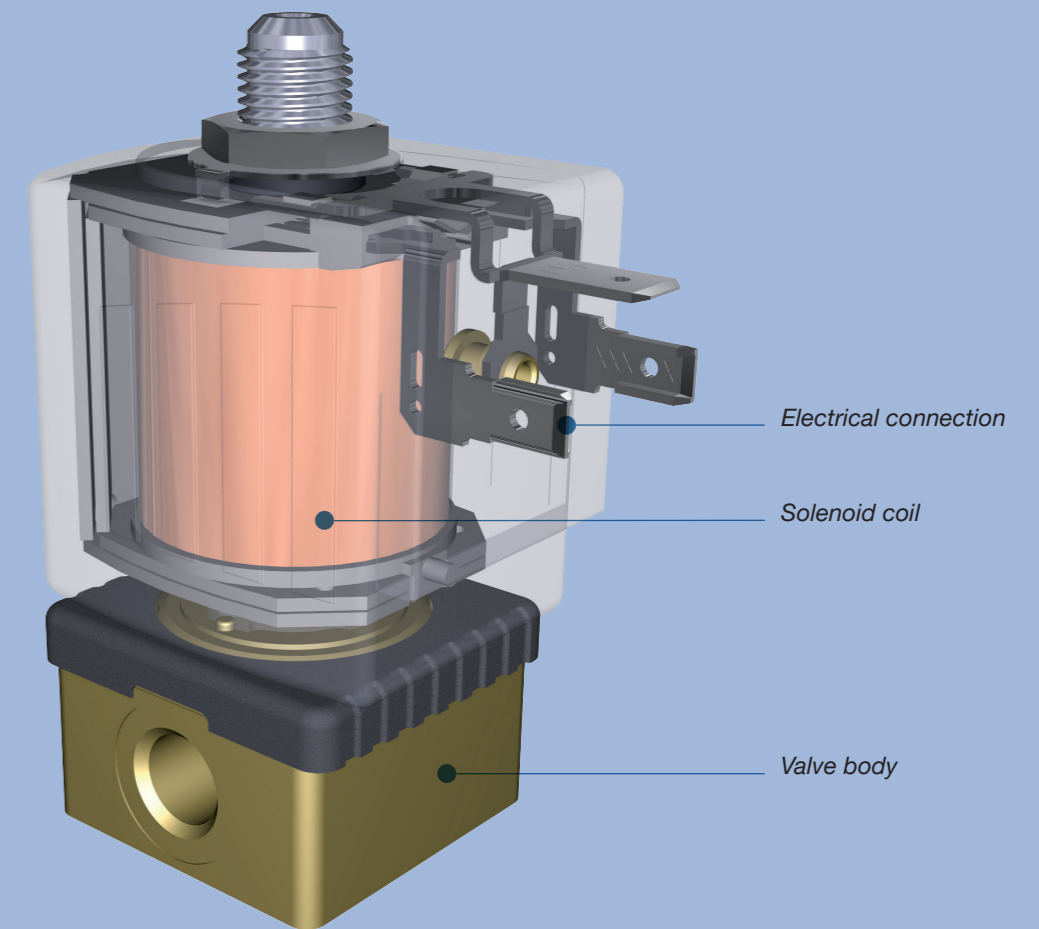

3/2-way plunger-type solenoid valve type 6014

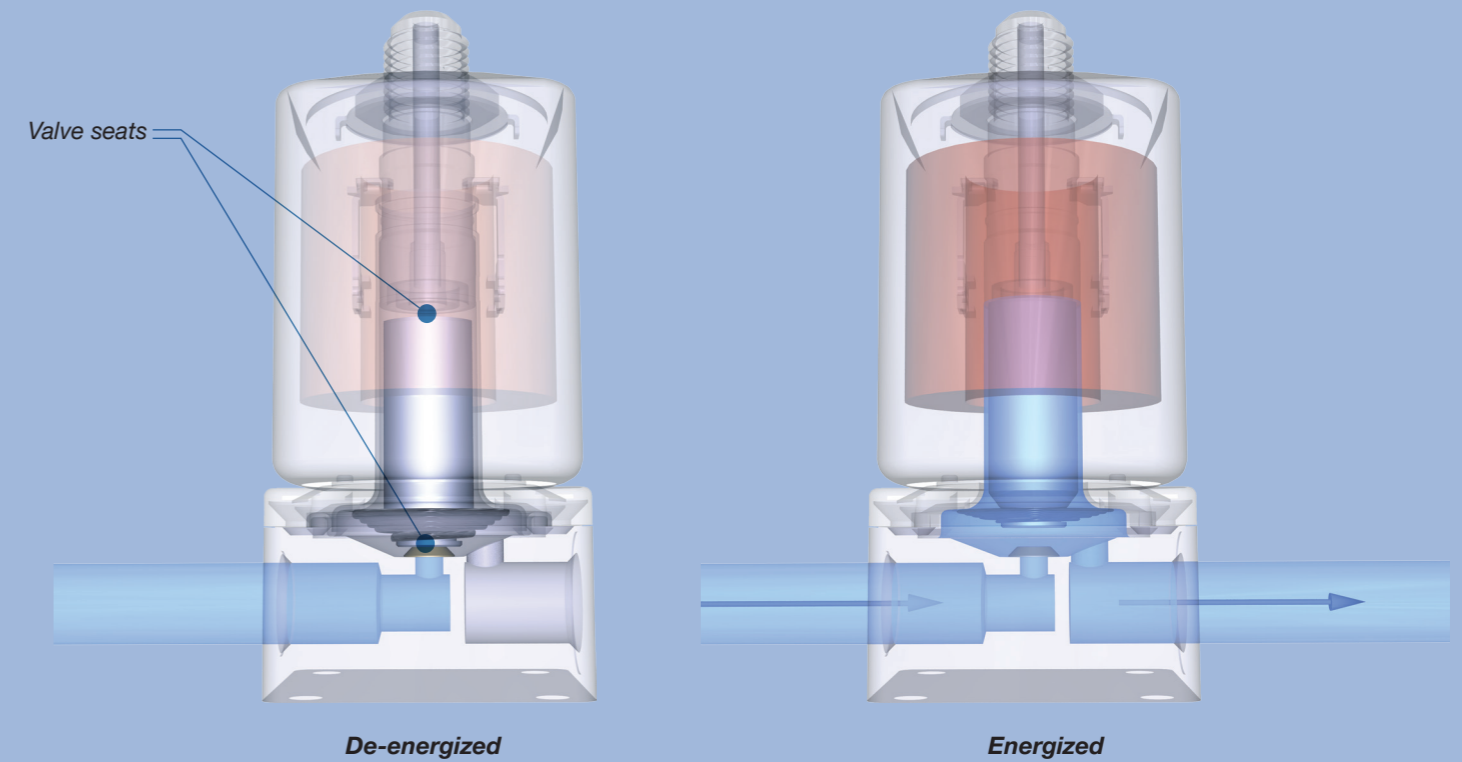

Robust Single and NAMUR Valves

This series offers high flow rates of up to 2000 l/min (Q_{Nn} value) with low power consumption. The valves can be used singly or on blocks and feature the functional principle of the type 6014 solenoid valve as a pilot control valve. During installation, this pilot control valve is adapted to the main valve, the so-called pneumatic booster.

Whatever your requirements and ambient conditions may be.

In the case of the pneumatic valves in the standard, Ex-i, Ex-m or NAMUR version, we offer suitable valves made of polyamide, aluminium and stainless steel for every application – also for use in extreme environments with temperatures down to -40 °C, outdoor installations or chemical applications.

The 3-D animated graphic shows the standard version type 6519 valve. When the solenoid is switched off, the unit is de-energized. If current is applied to the solenoid, the pilot control valve releases the pilot valve and therefore enables switching of the main valve.

A special feature of the NAMUR version is the included adapter plate, which makes it possible to easily operate the valve as a 3/2-way or a 5/2-way valve.

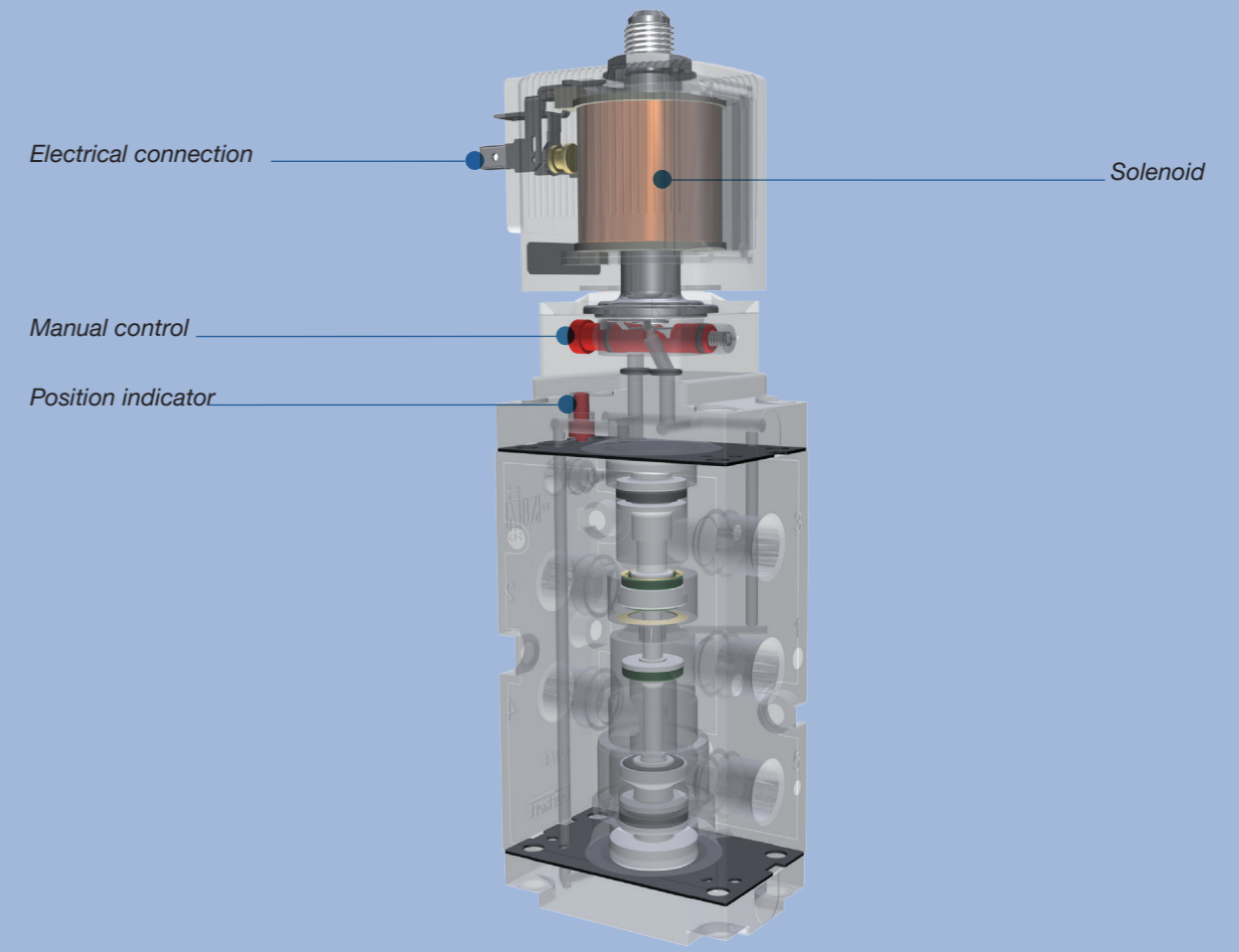
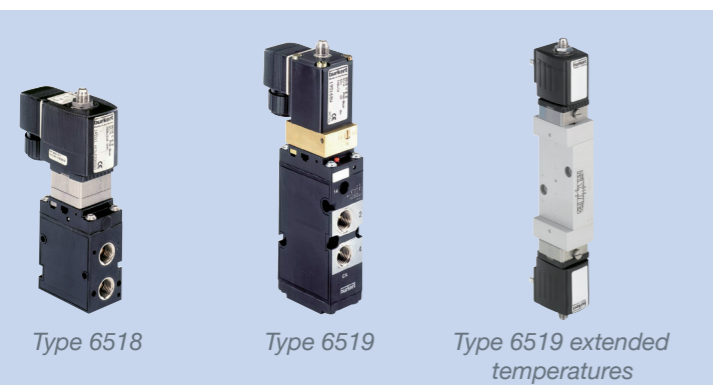

5/2-way and 3/2-way pneumatic valve type 6519

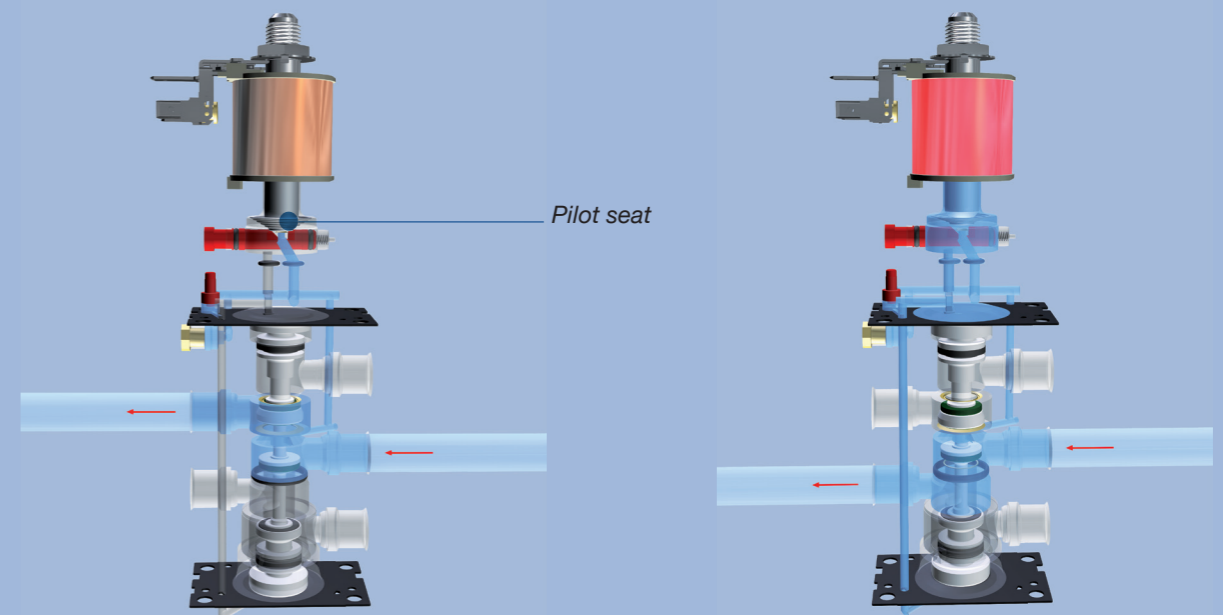

De-energized position of the 5/2-way valve

Switched position of the 5/2-way valve

Pilot for Pneumatically Operated Valves

The term “control unit for pneumatic actuators” refers to a converter function unit which is able to issue corresponding pneumatic signals for controlling an actuator and which is controlled with low-energy, electrical, mechanical or pneumatic signals. These control units have electrically (magnetically), pneumatically or mechanically operated multi-way valves for switching compressed air.

These pneumatic valves can be differentiated as follows, based on the pilot system’s operating principle:

- pivoted armature
- plunger-type valves
- rocker valves
- flipper valves

For details about these principles see our Product Overview Solenoid Valves.

The illustrations on the opposite page show the flipper valve anatomy used as a pilot for pneumatic valves such as types 6524 and 6525.



Type 6144 single valve



Type 6144 block solution

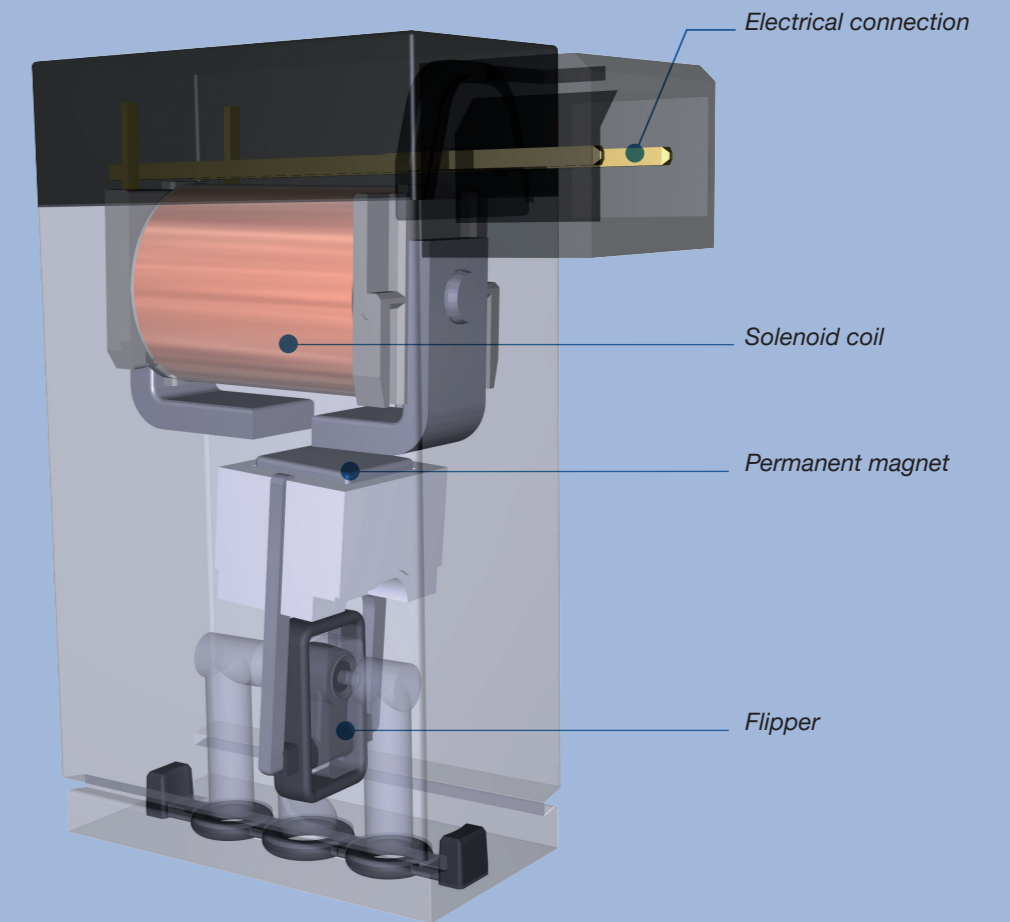

Direct-acting 3/2-way flipper valve type 6144

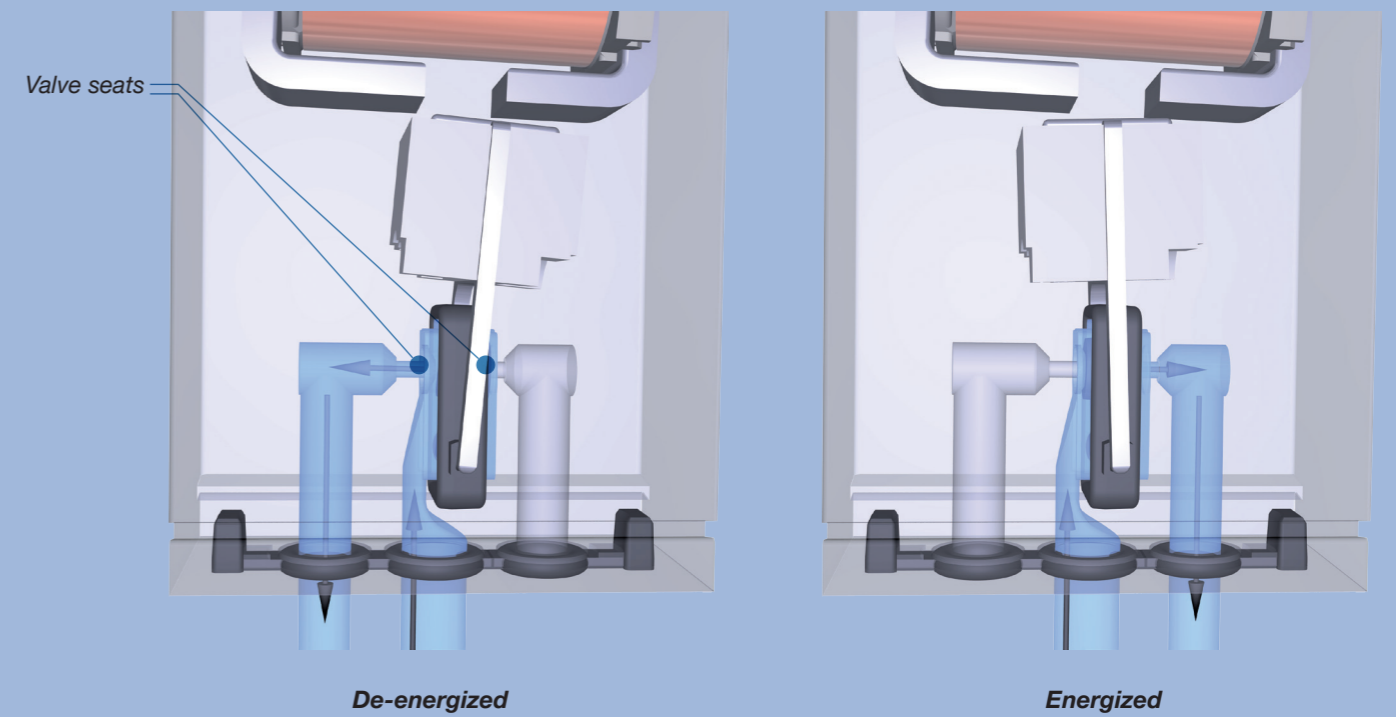

Pneumatic Valves Types 6524-6527

The valves feature a very compact design, which makes them ideal for block assembly. The valves are equipped with either a type 6144 flipper valve or a type 6106 rocker valve as the pilot control valve.

Type 6524 as a 3/2-way or 2x3/2-way valve (see animated graphic), like the type 6525 as a 5/2-way valve, is based on a flipper pilot control and a pneumatic seat valve. Both types, 6524 and 6525, allow a flow rate of 300 l/min. Types 6526 as a 3/2-way valve and 6527 as a 5/2-way valve use type 6106 as the pilot control valve and have a flow rate of 700 l/min. All valves of this series are equipped with a manual override as a standard feature and allow switching of high pressures with low power consumption and short switching times.

The 2x3/2-way version is a combination of two flipper valves and one pneumatic seat valve. This valve can either switch both 3/2-way functions simultaneously (as shown in the 3-D animated graphic) or each 3/2-way valve can switch separately.

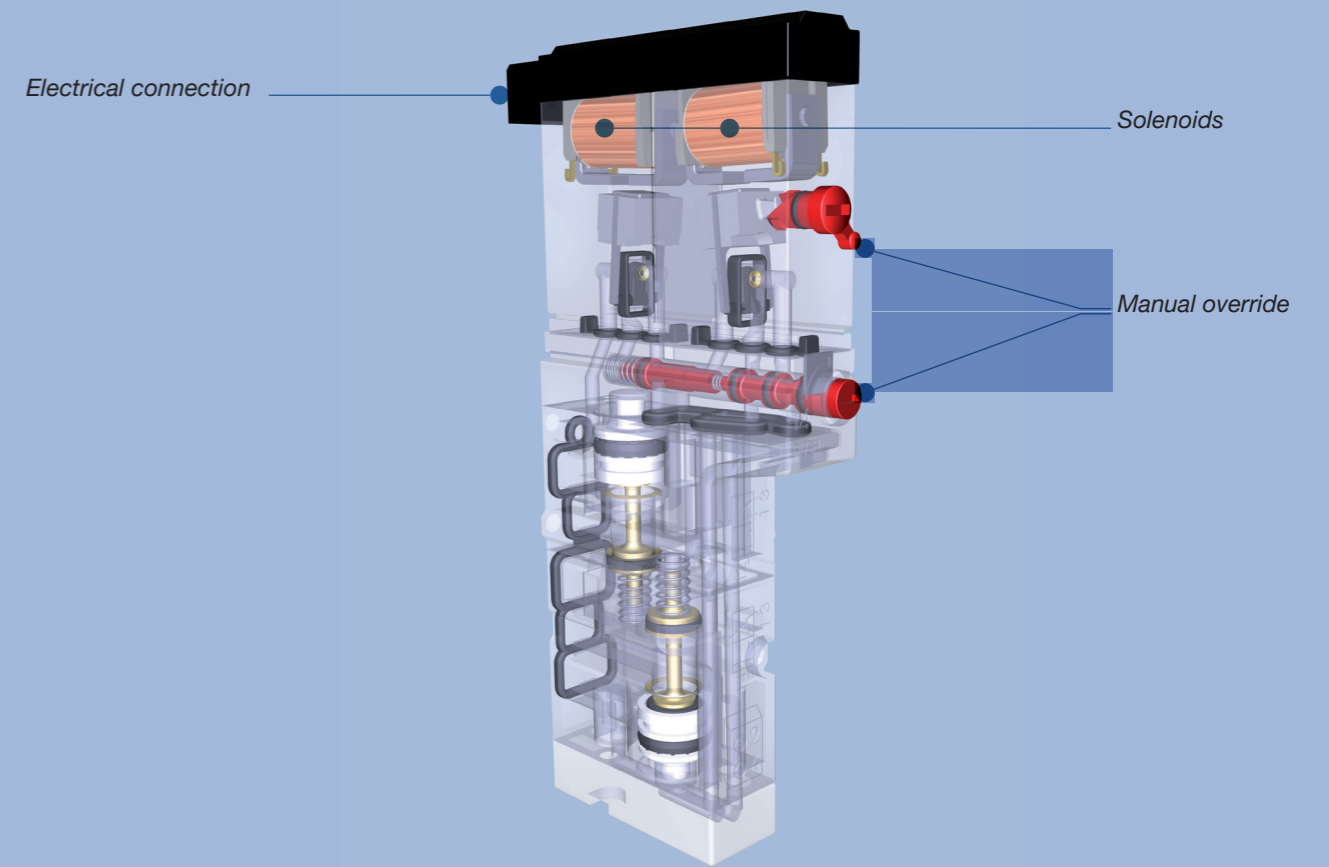

2x3/2-way pneumatic valve type 6524

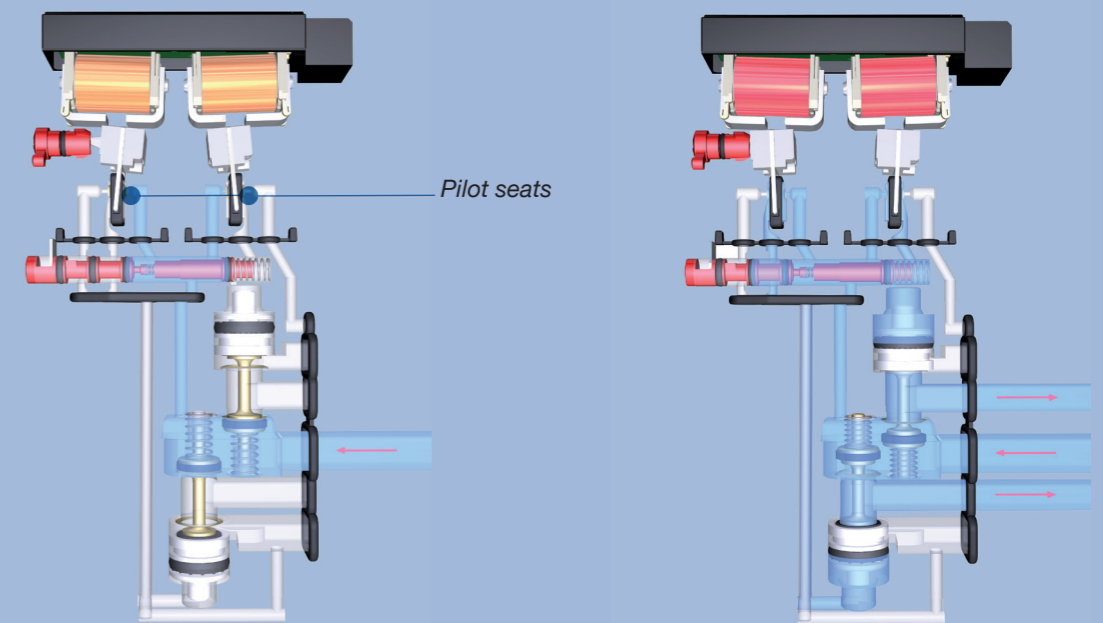

De-energized

Illustration shows simultaneous switching of both 3/2-way functions

Valve Island – Type 8647

The pneumatic valve island, Type 8647 AirLINE SP, is a modular, electropneumatic automation system consisting of connection modules and valve modules. It is perfectly designed for safe and complete integration into the decentralized peripheral system "SIMATIC ET 200SP" from Siemens. Type 8647 is used to integrate pneumatic pilot valves directly into the SIMATIC ET 200SP and to control them via the ET 200SP. Pneumatically actuated process valves, pneumatic cylinders or other pneumatic components can be connected to the pneumatic outputs. If the pneumatic components are installed with digital feedbacks, the position of the actuated pneumatic components can be displayed on the associated pilot valve. This can save time on commissioning and maintenance.

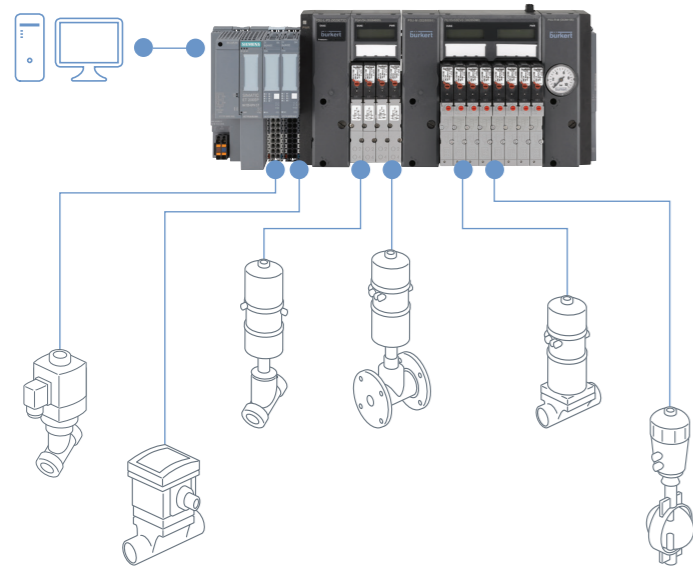

LC-Displays

Anzeige von ...

To show ...

- Pilot valve + process valve status
- Wire breakage | Short circuit | Pressure values
- Other individually configurable warnings and messages

Communication interfaces

- PROFINET IO, PROFIBUS DP
- A complete line of SIMATIC ET 200SP modules is available

Safe shut-off

- by module: shutdown of 4 or 8 valve positions
- by channel: shutdown of single valve (Types 6524+6525)

Pneumatic functions

- Hot swap function
- Check valves

Modular expandability

- Input modules such as manometers and pressure sensors

Valve Island – Type 8652

The pneumatic valve island type 8652 AirLINE is especially developed for applications in process automation. New diagnosis functions can be visualized at the LC-Display. Both cleartext as well as symbols show information which makes easy to relate the shown diagnosis. This saves time during installation and commissioning.

Furthermore the diagnosis information is also available in the PLC which enables a fast overview about the plant status. The hardware is optimized for installation at the cabinet bottom. Of course to fix the AirLINE at DIN rail is possible as well.

Besides important pneumatics functions ensure increased process safety. For instance the checkvalves make sure not to get an unplanned actuation due to pressure peaks.

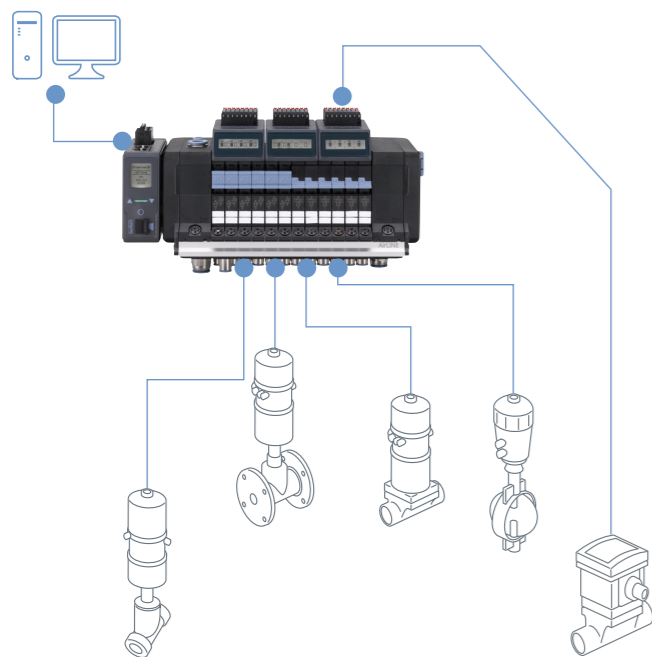

Safety-related shutdown

- Module-based
- Channel-based (Pneumatic valve SIA variant)

Power supply

- Pneumatic valves
- Communication and display

Communication interfaces

- Industrial Ethernet (EtherCAT, EtherNet/IP, PROFINET IO, Modbus TCP)
- PROFIBUS DP
- bûS / CANopen
- CC-Link

Digital feedbacks

- Compact and space-saving design
- Directly integrated in valve island

LC-Displays
To show ...

- Pilot valve + process valve status
- Wire break | Short circuit | Pressure values
- Other individually configurable warnings and messages

Robust manual operations

- Spring return, latching, locked
- Visual position indication

Pneumatic functions

- Hot-Swap functions
- Check valves

Pressure measurement module

- Pressure sensor directly integrated
- Pressure monitoring of the pneumatic supply

AirLINE Quick

- Fast and easy tubing

Valve Island – Type 8653

The valve island Type 8653 AirLINE has been especially developed for applications in process automation. New diagnostic functions can be visualised at the LC display, both in clear text as well as symbols. This makes it easy to relate to the shown messages and helps to save time during start-up and maintenance.

Furthermore the diagnostic message is also available in the control. This enables a fast overview of the plant status. The hardware structure is optimized for installation close to the actor. An intelligent mounting system offers various installation solutions. Of course it is also possible to fix the AirLINE Field to top hat rail. Moreover, key pneumatic functions ensure increased process reliability. For instance, the non-return valves in the exhaust air ducts make sure there is no unplanned actuation due to pressure peaks

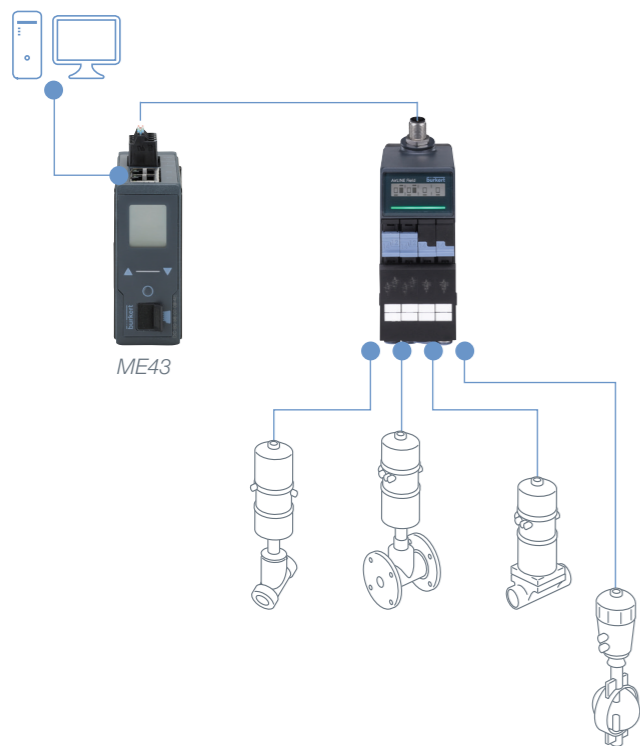

Communication interfaces ME 43

- Industrial Ethernet (EtherCAT, EtherNet/IP, PROFINET IO, Modbus TCP)
- PROFIBUS DP
- bÜS / CANopen



LC-Displays

To show ...

- Pilot valve + process valve status
- Wire break | Short circuit | Pressure values
- Other individually configurable warnings and messages



Robust manual operations

- Spring return, latching, locked
- Visual position indication

Valve Block – Type 8640

The 8640 valve block is designed to solve diverse and complex control problems due to its systematic modular construction. Different valve functions can be combined on one block without a common electrical control.

Following Bürkert pneumatic valve types can be mounted on a valve block:

- Type 6144
- Type 5470
- Type 6518/6519
- Type 6524/6525 Non-Ex and EEx-i
- Type 6526/6527 Non-Ex and EEx-i

Every single pneumatic valve on the block is wired separately with the control system. Each valve has the task of controlling a single- or double acting actuator. Valve blocks are mainly used in simple and small pneumatic applications.

With valves for hazardous areas, these valve blocks can be used in explosion proof areas.

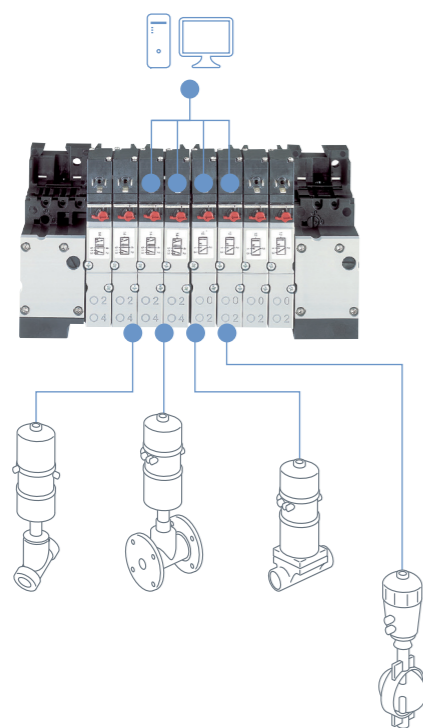

- *Pneumatic basic modules in different sizes*
- *Pneumatic features:*
 - *Pneumatic HotSwap function (P shut-off): replacement of valves during operation possible*
 - *Additional protection in your device with check valves*
- *Possibility to combine different valve functions on a single valve block:*
 - *3/2-way valve*
 - *5/2-way valve*
 - *2x3/2-way valve*

• *Pneumatic supply: common supply of valves with compressed air as well as common exhaust air lines*

Possible functions and versions of the valve block type 8640

Flow rate of valves	Valve functions	Pressure range
150 l/min*	3/2-way 2x3/2-way 5/2-way	Vacuum 1–10 bar
300 l/min	3/2-way 2x3/2-way 5/2-way	Vacuum 1–10 bar
700 l/min	3/2-way 5/2-way	1–10 bar
1300 l/min	3/2-way 5/2-way 5/2-way bi-stabile 5/3-way	2–8 bar 3–10 bar

* with integrated process reliability features: pneumatic HotSwap function and check valves in the exhaust air ducts

Valve Island – Type 8640

AirLINE type 8640 is a modular automation system with a protection class up to IP 54. The valve island uses digital feedback inputs for the control of sensor signals and pneumatic outputs for the control of single and double-acting process valves. By putting together a row of pneumatic modules with different numbers of valves, 8 to 24 valve functionalities may be realized on one valve island. Electrical connectivity is achieved by either fieldbus interfaces, common connection or multipin.

Some special features make a Bürkert valve island unique: With integrated HotSwap function (P shut-off) you are able to replace a valve even during operation and additional integrated check valves in the pneumatic basic modules give a better protection for your installation.

The diverse applications of the type 8640 can be expanded by AirLINE Quick – the adapter for valve terminals and automation systems. AirLINE Quick can be mounted directly on the wall or floor of the control cabinet.

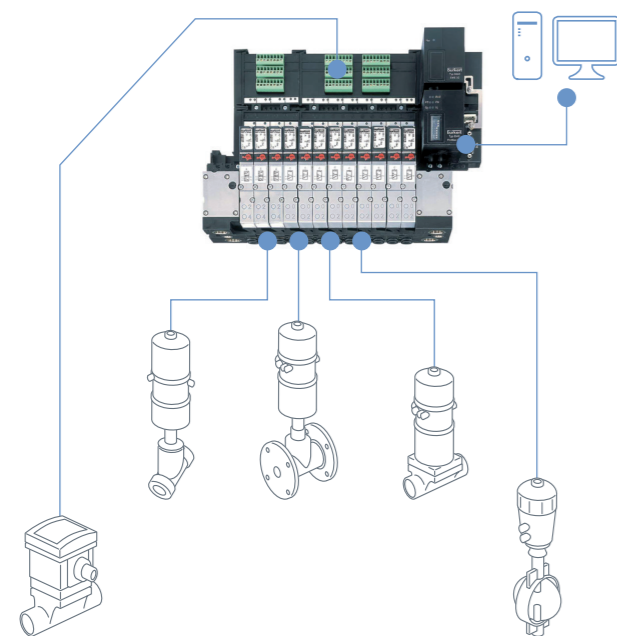

- Digital feedback inputs
- Termination modules for electrical modules
- Basic electrical modules for valves supply
- Pneumatic basic modules in different sizes
- Pneumatic supply: common supply of valves with compressed air as well as common exhaust air lines
- Pneumatic features:
 - Pneumatic HotSwap function (P shut-off): replacement of valves during operation possible
 - Additional protection in your device with check valves

- Expansion modules for digital inputs
- Communication modules:
 - fieldbus technique
 - Profinet IO
 - Ethernet / IP
 - Modbus TCP
 - Profibus DP
 - DeviceNet
 - CANopen
 - conventional wiring
 - multipin
 - common connection
- Possibility to combine up to 24 valve functions on a single valve block:
 - 3/2-way valve
 - 5/2-way valve
 - 2x3/2-way valve
 - 5/2-way valve bistable
 - 5/3-way valve

Possible functions and versions of the valve terminal type 8640

Flow rate of valves	Piloting	Valve functions	Pressure range
150 l/min*	Common connection Multipin	3/2-way 2x3/2-way 5/2-way	Vacuum 1–10 bar
200 l/min	Profinet IO Ethernet / IP	5/2-way bi-stabile 5/3-way	2–7 bar
300 l/min	Modbus TCP Profibus DP DeviceNet CANopen	3/2-way 2x3/2-way 5/2-way	Vacuum 1–10 bar
700 l/min		3/2-way 5/2-way	1–10 bar

* with integrated process reliability features: pneumatic HotSwap function and check valves in the exhaust air ducts

Process Control Centers AirLINE – Type 8644

AirLINE type 8644 uses digital and analogue inputs for the control of sensor signals and uses digital and analogue outputs for the control of complete decentralized control systems. Our expertise lies in the supervision and control of complete loops including flow, pressure, temperature and level.

Special features make Bürkert AirLINE unique:

- Our groundbreaking modular system fit in your world and in your cabinet
- AirLINE with WAGO I/O System 750 and AirLINE with Siemens ET 200S can be used in hazardous applications in Zone 2
- With integrated Pneumatic HotSwap function (P shut-off) you are able to replace a valve even during operation
- Additional integrated check valves give a better protection for your installation
- Perfect process pneumatics with multiple communication possibilities

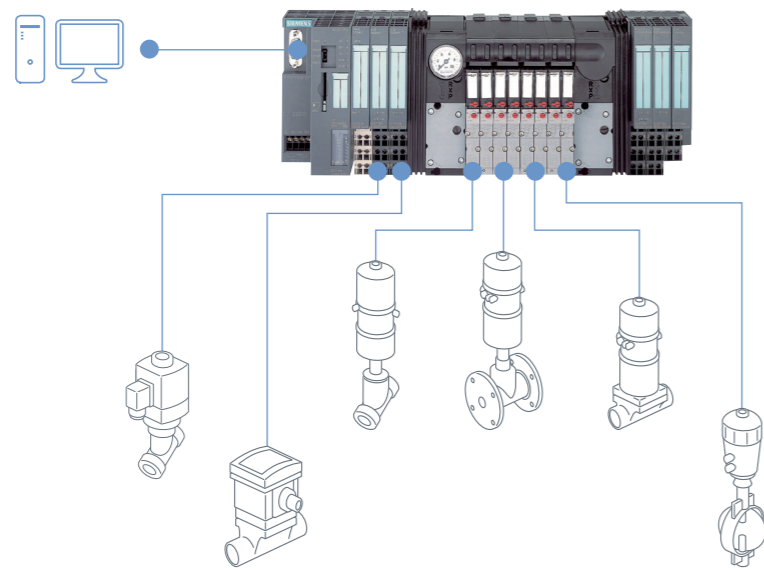

Possible functions and versions of the automation system type 8644

Flow rate of valves	Piloting	Valve functions	Pressure range
150 l/min*	dependent on cooperation partner	3/2-way, 2x3/2-way, 5/2-way	Vacuum 1–10 bar
200 l/min		5/2-way bi-stabile, 5/3-way	2–7 bar
300 l/min		3/2-way, 2x3/2-way, 5/2-way	Vacuum 1–10 bar
700 l/min		3/2-way, 5/2-way	1–10 bar

* with integrated process reliability features: pneumatic HotSwap function and check valves in the exhaust air ducts

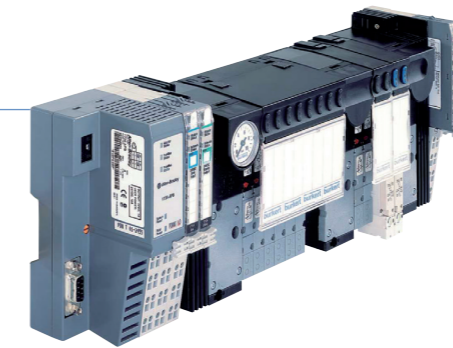

AirLINE Typ 8644, Rockwell Point I/O-System

Fully compatible with Rockwell Point I/O
Modular system with protection type IP20

Communication options:

- ControlNet
- DeviceNet
- Ethernet/IP
- Profibus DP

AirLINE Typ 8644, WAGO I/O-System 750

The automation system for process control AirLINE is fully compatible with the WAGO I/O system 750 and integrated pneumatic valves; electronic input/output for remote control and field bus communication in a compact and flexible assembly. Suitable for applications in hazardous areas, ATEX Zone 2. Field bus interfaces:

- Profibus DP
- Modbus TCP
- Ethernet/IP
- CC-Link
- Profinet IO
- CANopen
- Interbus
- DeviceNet
- EtherCAT

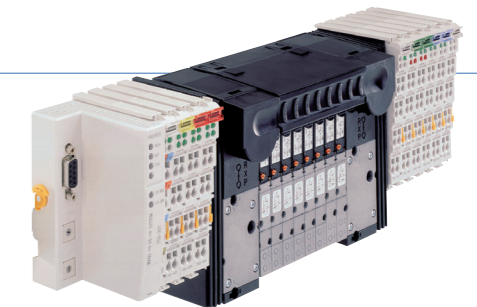

AirLINE Typ 8644, Siemens ET 200S

Modular pneumatic seat valve with fieldbus and digital/ analog I/O-modules. This automation system is suitable for all functions including use in hazardous areas ATEX Zone 2.

Field bus interfaces:

- Profibus DP
- Profinet

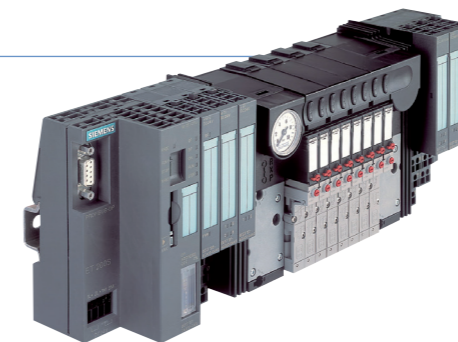

AirLINE Typ 8644, Phoenix INLINE-System

The automation system AirLINE is fully compatible with the Phoenix INLINE-System. Pneumatic valves, electronic input/output for remote control and field bus communication are integrated in a compact and flexible module for process control. Field bus interfaces:

- Profibus DP
- Interbus
- Ethernet/IP
- CANopen
- Profinet IO
- DeviceNet
- Modbus TCP
- AS-i

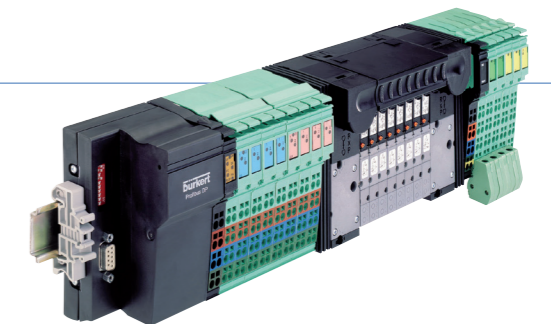

Automation System AirLINE Ex – Type 8650

AirLINE Ex type 8650 is a modular electrical and pneumatic automation system that controls complex processes in hazardous areas (Zone 1/21). The protection class “intrinsically safe” (Ex-i) of electronic modules and valves allows the change of modules during operation. The valve slices with up to 8 channels offer compact design for areas with a high density of signals. Combined with the modules from our cooperation partner Siemens, Bürkert offers electrical, ana-logue and digital I/O functions for use in Zone 0.

Approved according to:

- ATEX
- IEC-Ex and
- FM-Ex.

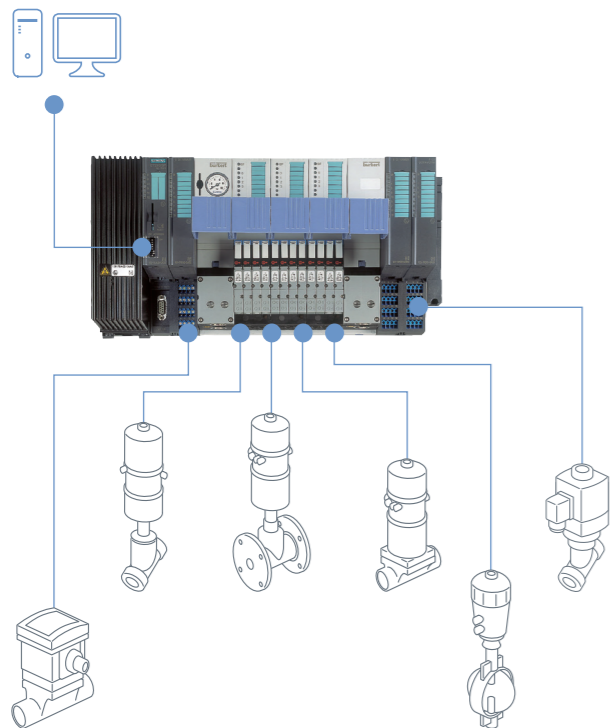

- Supply slice left
- Interface Module Profibus DP-is
- Power supply module

Automation System AirLINE Ex Type 8650 may contain up to 32 modules.

- Electronic modules
- Valve slice
- Possible valve functions:
 - 3/2-way valve Ex-i
 - 5/2-way valve Ex-i
 - 2x3/2-way valve Ex-i

With the additional module type 0498 you are able to realize a 5/3-way function.

Possible functions and versions of the automation system type 8650

Flow rate of valves	Piloting	Valve functions	Pressure range
150 l/min*	Profibus DP-is	3/2-way 2x3/2-way 5/2-way	2,5–7 bar
300 l/min		3/2-way 2x3/2-way 5/2-way	2,5–7 bar
700 l/min		3/2-way 5/2-way	2–8 bar

* with integrated process reliability features: pneumatic HotSwap function and check valves in the exhaust air ducts

Cabinet Know-how

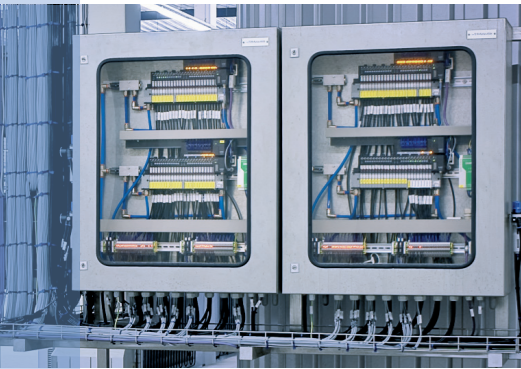

We have intimate knowledge of the main panel components. We combine pneumatics, communication and networking into simple turnkey solutions.

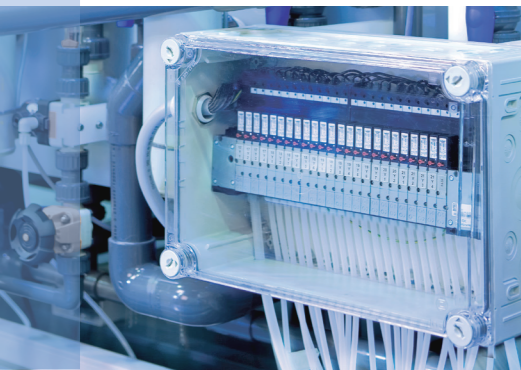

We strive to understand the exact needs and requirements of our customers. We deliver according to precise project management time scales.



We understand what is required for process cabinets in demanding environments.



We deliver and commission complete solutions for process environments, including hazardous locations.



Higher Flexibility in the Control Cabinet with AirLINE Quick

AirLINE Quick, the adapter for valve terminals and automation systems, significantly reduces the number of components in the control cabinet. You need fewer pneumatic hoses and cables and can integrate AirLINE Quick directly in the floor or wall of the switch cabinet, eliminating the need for bulkhead connections on the cabinet.

A unique feature of the type 8640 and the type 8644 automation system is the combination of the pneumatic connections, field bus interface and I/O modules directly on the floor or wall of the switch cabinet, which means that the switch cabinet can be generally smaller than in the past.

In addition to the stainless steel version of AirLINE Quick for hygienic applications the concept is also available for general purpose applications with an anodized aluminium adapter plate and nickel-plated brass pneumatic connections.

For further information please have look in our brochure "Standard Program AirLINE and AirLINE Quick Type 8040 & 8644".

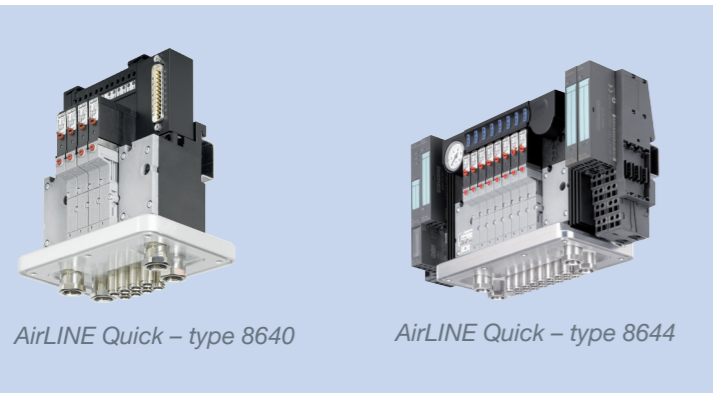

Valve functions per station
 For type 8640: 8, 12, 16 and 24
 For type 8644: 8, 16 and 32

Pneumatic connections
 Supply/release:
 - G 1/4
 - NPT 1/4

Pneumatic connections
 Supply in stainless steel 1.4301
 or Nickel-plated brass:
 - Push-in 6mm
 - D 1/4"

Adapter plate
 in stainless steel
 1.4301 or anodized
 aluminium

Adapter for valve terminal type 8640 (shown here) or the automation system type 8644

AirLINE Quick Adapter

Valve terminal type 8640
 with Profibus DPV1, 24
 valve functions and 24
 digital inputs

Installation of AirLINE Quick in the switch cabinet
 Installation location: Wall or floor of the control cabinet

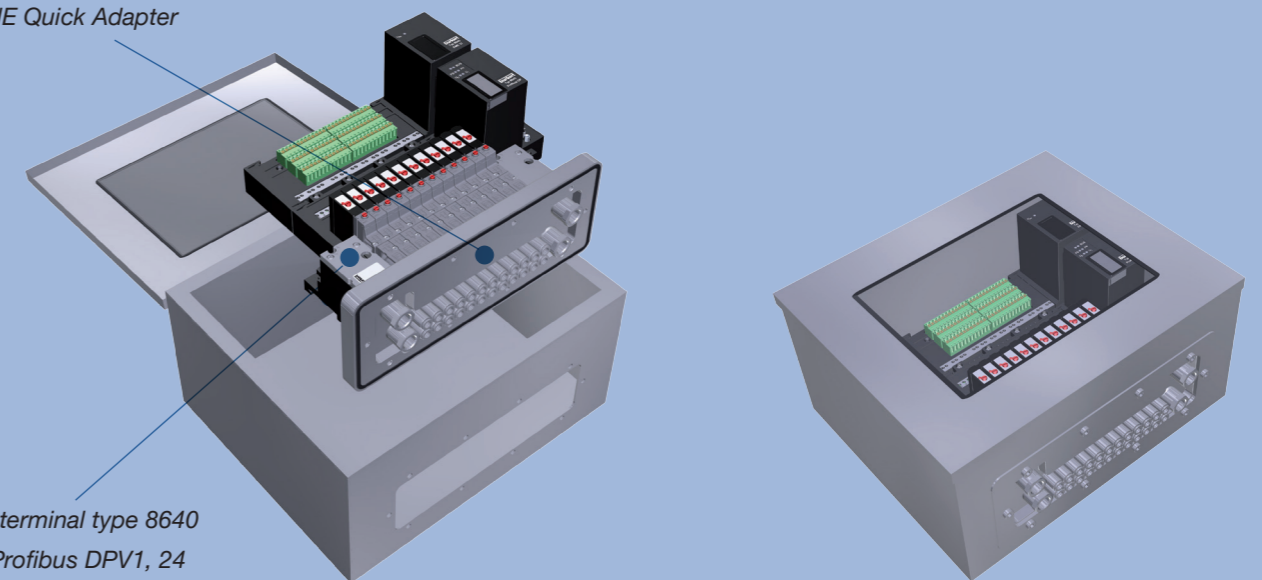

ELEMENT – Continuous Advantages

Mechanical

- Optimised for cleaning and use in wet areas of hygienic processing plants
- Designed according to EHEDG guideline for materials compatibility, smooth surfaces and external seals
- Optical on the site status indicators via coloured high power LEDs
- End position detection via micro switch, 3- / 2- wire initiator to wear-free working, analogue, inductive sensor with teach function
- Intergrated pilot valves with manual operation
- Control air filter protects from raw pollution
- Over pressure valve
- Electrical connection via plug-in connector M12 stainless steel or cable gland
- ATEX Zone 2/22 and Zone 1 (optional)

Communication

- AS-interface
- DeviceNET
- IO-Link
- Bürkert system bus (büS) based on CANopen

Automation concept

- Robust and practice-oriented solution for decentralized automation concepts
- Automation functions can be integrated modularly in the pneumatic actuator
- Minimalization of the electrical wiring and pneumatic piping
- Manual actuation and status indication in the field
- Manual operating level and status display on site in the plant

Set up

- Extremely compact integrated actuation to pneumatic actuator
- Internal control air routing without external wiring
- Control air supply to drive chambers by compressed air recycling
- Over pressure as additional protection against condensation in the actuators
- Can be also combined with the CLASSIC actuators 2000, 2012, 2031

Look and Feel

- Exceptional
- Compact
- Hygienic



Control heads for the integrated mounting on process valves

On/Off valves



Type 8690



Type 8697

Pneumatic control with integrated pilot valve and mechanical or inductive End position indicators



Type 8691



Type 8695

Control head with integrated pilot valve, contactless position sensor with teach function and coloured status display via high-performance LEDs, communication via AS-interface, DeviceNet, IO-Link or büS



Type 2100
2/2-way angle-seat valve with ELEMENT design, DN 13-50.



Type 2101
2/2-way globe valve with ELEMENT design, DN 13-50.



Type 2103
2/2-way diaphragm valve with ELEMENT design, DN 4-25.

More Process Reliability – Pneumatic HotSwap and Check Valves



For valve blocks, valve terminals and automation systems there are several integrated process reliability features such as check valves, which are integrated in the exhaust air ducts of the pneumatic base module, and the pneumatic HotSwap function, which enables the replacement of a valve during operation. These process reliability features are very important especially in a hygienic environment.

The pneumatic HotSwap function allows removal of a valve from the valve block, valve terminal or automation system by loosening two mounting screws. This exposes the pneumatic base module with the integrated pneumatic HotSwap function (see illustration at the top right). A small air jet can escape from the pneumatic base module, without significantly affecting the air pressure on the entire block. A new valve can then be mounted on the empty valve port and is then immediately ready for use.

Check valves provide for more process reliability. In case of a disturbance in the system, all actuators are shut down simultaneously, so that the exhaust air from all actuators has to be released into the environment. This can result in pressure build-up in the valve block, since the air cannot be released quickly enough. This back pressure can cause unwanted switching of a valve, which can have serious consequences for a process. If check valves are integrated in the base module, a problem in the process cannot arise in the first place (see illustration at bottom right).

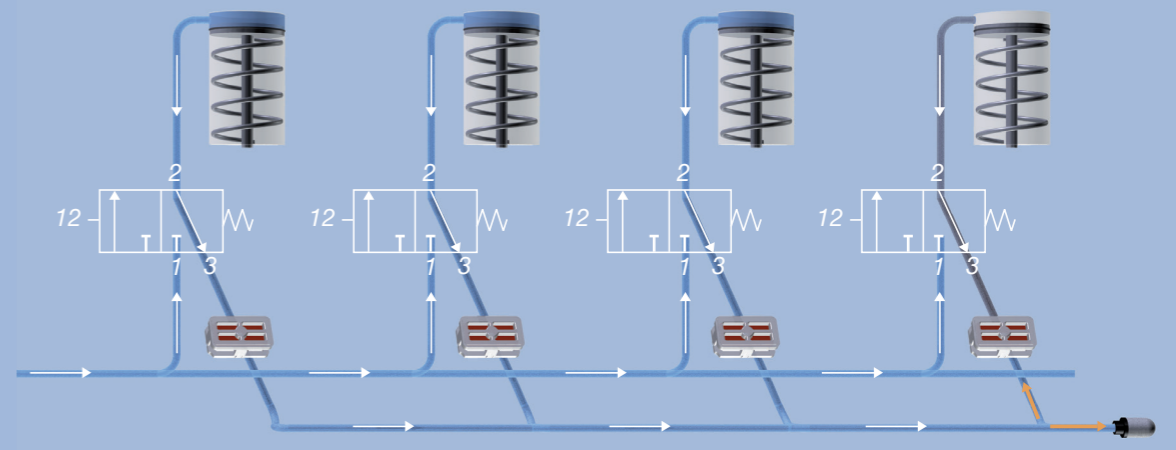
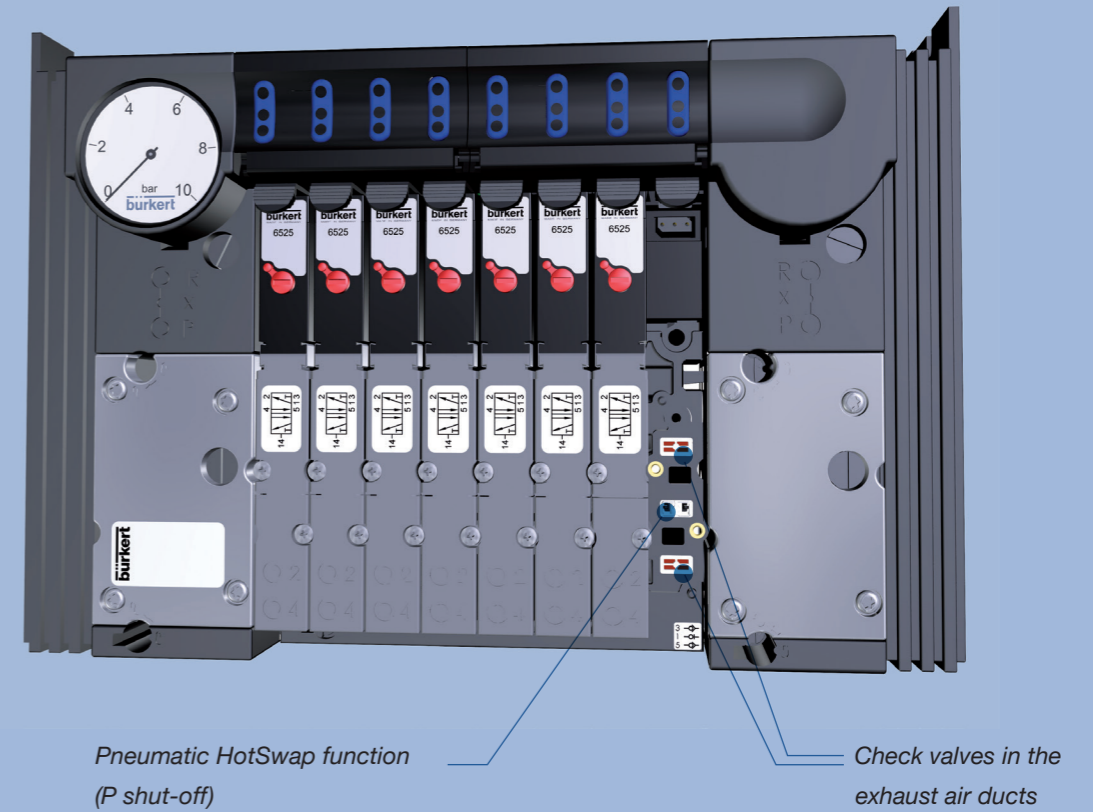

More process reliability due to check valves

Selection Criteria for Multi-Way Valves

- Final control element, single or double-acting
- Circuit function of control valve
- Flow rate/nominal diameter
- Tube length
- Pilot pressure
- Switching speed
- Operating voltage
- Installation method and location
- Port connections
- Ambient conditions

Actuators, circuit function

The required circuit function for the pilot valve results from the actuator's mode of operation (single or double-acting). The options are shown in the table on page 24, along with the circuit functions for multi-way valves. Correct dimensioning of the pilot valve, allowing for the supply line, is very important.

Selection of pilot valves (multi-way valves), allowing for the air capacity

The pilot valve has the task of filling or venting – via a supply line – the actuator within a specific time. The shorter the response time of the actuator, the higher the air capacity requirement of the pilot valve. The reset time of single acting actuators can be reduced by using quick exhaust valves, directly mounted on the actuator. In process automation, larger actuators often need to switch slowly and switching times of up to half a minute are accepted. In factory automation it is different and switching times often have to be as fast as possible.

A tube represents an additional flow resistance and a disadvantageous volume. Thus, shortening the tube length reduces the volume to be filled and allows the usage of “smaller” control valves. Experience indicates that the flow rates can drop up to 50 % after approx. 3 – 4 m tube length and can also drop by an additional 20 – 30 % after a further 10 m (see diagram on the right page). Consequently, the losses must also be taken into account when selecting the valves and when dimensioning the tubes.

In addition, it must be ensured that lines are routed as straight as possible, with no kinks, pinching points or elbows, since they can impair the flow conditions, i. e. increase the flow losses in the tube. The diagram also clearly shows that higher flow rates are achieved by increasing the tube's inside diameter from 6/4 mm to 8/6 mm.

The diagram shows the effect of the tube lengths (6/4; 8/6 mm) on the air flow rate. Similar characteristics also result for tube sizes 10/8 and 12/10 mm. The measurements were conducted with multi-way valves at +20°C and at an input pressure of 6 bar. The configurators for the valve blocks and valve islands include a calculation tool for calculating flow rates.

However, it is difficult to give a statement about the real switching times of an actuator, connected in the end of a tube. Further criteria influencing the switching time are the force of the spring package inside the actuator, friction forces and possibly the media pressure.

Q_{Nn} value (tube size 6/4 mm, 8/6 mm)

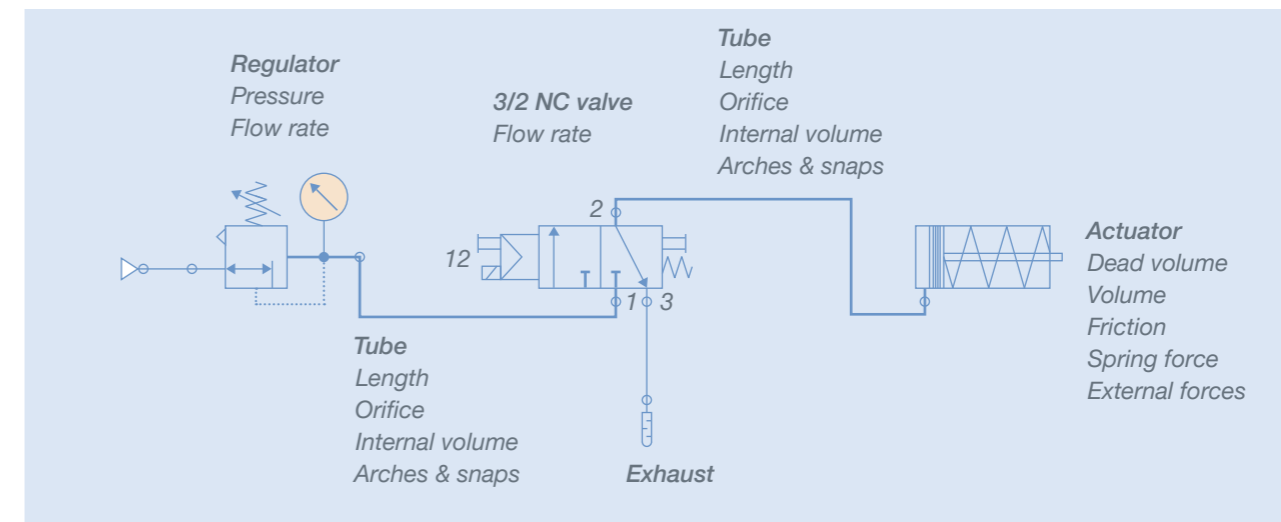
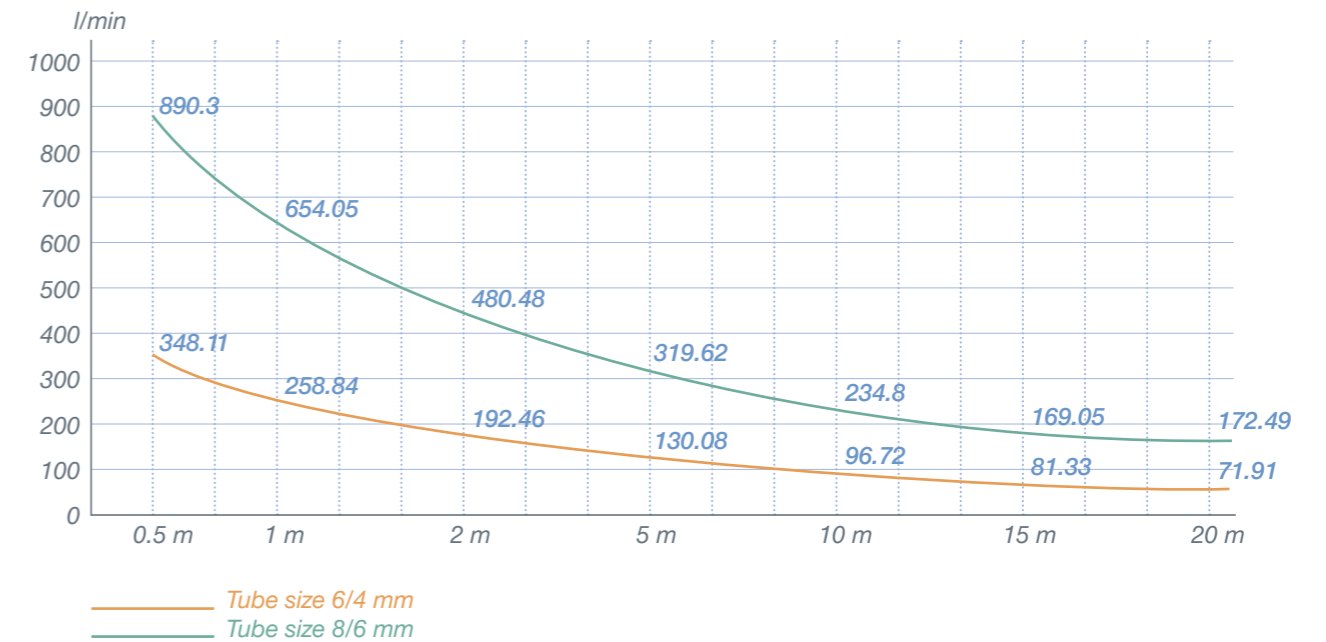



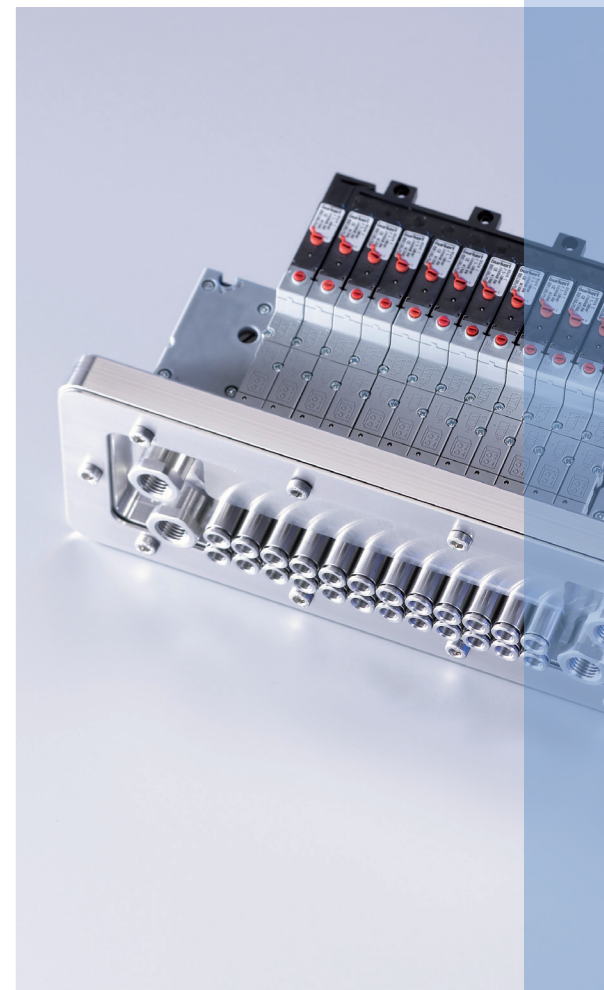

Different Multi-Way Valves

Circuit functions (WW) and possible applications of multi-way solenoid valves

WW	Circuit Symbol	Circuit Function	Possible Applications
A		2/2-way solenoid valve, direct-acting; normally closed; switching without pressure differential	Opening, closing of compressed air lines
A		2/2-way solenoid valve, servo-assisted; normally closed; pressure differential required across valve	Opening, closing of compressed air lines
C		3/2-way solenoid valve, direct-acting; service port 2 normally vented via outlet 3; switching without pressure differential	Pilot valve for single-acting final control elements (low air capacity)
C		3/2-way solenoid valve, servo-assisted; service port 2 normally vented via outlet 3	Pilot valve for single-acting final control elements (high air capacity)
D		3/2-way solenoid valve, direct-acting; service port 2 normally pressurized; switching without pressure differential	Pilot valve for single-acting final control elements (no air capacity)
D		3/2-way solenoid valve, servo-assisted; service port 2 normally pressurized; pressure differential required across valve	Pilot valve for single-acting final control elements (high air capacity)
G		4/2-way solenoid valve, servo-assisted; service port 2 normally pressurized and service port 4 normally vented via outlet 3	Pilot valve for double-acting final control elements; 2 and 4 are always vented via 3
H		5/2-way solenoid valve, servo-assisted; service port 2 normally pressurized and service port 4 normally vented via outlet 5	Pilot valve for double-acting final control elements; venting 2 via 3 and 4 via 5
L		5/3-way solenoid valve, servo-assisted; Position 1: pressure on 2; 4 vented Position 2 (center): everything shut off Position 3: pressure on 4; 2 vented	Pilot valve for double-acting final control elements; lifting, holding and lowering
N		5/3-way solenoid valve, servo-assisted; Position 1: pressure on 2; 4 vented Position 2 (center): 2 and 4 vented Position 3: pressure on 4; 2 vented	Pilot valve for double-acting final control elements; 2 and 4 vented in center position



Symbols for the actuating elements on the valve:

-  Solenoid actuator
-  Pilot valve
-  Mechanical spring
-  Pneumatic return

Approvals Behind our Success

Individual directives and national standards have resulted in clear standards that have been implemented in national or international law by the legislature. These recognized regulations ensure that equipment items from different countries are compatible and that manufacturers adhere to a set of regulations regarding design and production.

These regulations relate to the following aspects:

- Protection against risks and dangers
- Interfaces between technical systems
- Testing and inspections of products
- Clear description of the content and the characteristics of products

Legal supervisory authorities require that system operators use only equipment which meets the necessary safety requirements pursuant to these regulations.

Bürkert has the largest number of valves which have been granted the corresponding global approvals.

European approvals

The European approvals and CE mark must be considered in conjunction with one another. As products with CE marking comply with the specified safety regulations, these marked products must be accepted in all EU and EFTA states. A distinction is made between the regulated and unregulated area. The CE mark on Bürkert devices refers to

- Electromagnetic compatibility in the areas
- Low Voltage Directive with the following limits:
 - 75–1500 V for DC voltages
 - 50–1000 V for AC voltages
- Pressure Equipment Directive

In regulated areas, the requirement stipulates that an independent body must conduct an CE type examination:

- Pressure Equipment Directive
- Gas Appliances Directive
- ATEX Directive

In unregulated areas, it is the manufacturer's direct responsibility to attach the CE mark. In this case, a Declaration of Conformity may be required of the manufacturer, specifying the standards applied. Depending on the particular application, the following directives may apply to Bürkert:

- Low Voltage Directives
- Electromagnetic Compatibility Directive
- Vehicle Directives
- Medical Device Directives

German approvals

VDE approval applies to water valves for domestic use where the most important requirements are electrical safety requirements, stipulated function behavior, water hammer, tightness and mechanical strength of the fluidic components.

The KTW Recommendation is relevant to plastics in components used in drinking water and is also required for the use of solenoid valves with VDE approval in the drinking water sector. The hygiene requirement apply to non-metallic materials (e. g. elastomer seal materials) which come into contact with the medium and is taken as a basis for this recommendation in accordance with the specification of the competent Federal Agency.

Safety shut-off valve to EN 264 "Safety Shut-Off Devices for Combustion Plants using Liquid Fuels" is specified as the test regulation for this. A test laboratory (e. g. TÜV) draws up a report on the requirements which include functional behavior, continuous loading capability, electrical safety, tightness and mechanical strength of the fluidic components.

North American approvals

The American Occupational Safety and Health Administration (OSHA) drew up the OSHA Regulation. In Standard 29 CFR, the requirement for electrical installations or equipment stipulates that only installations or equipment which have been tested for the specified safety requirements by an NRTL (National Registered Test Laboratory) may be installed. The NRTLs specified include the following:

- Underwriters' Laboratories (UL) for UL-listed, UL-recognized, UL-classified
- Factory Mutual (FM)
- Canadian Standards Association (CSA)

The complete CSA approval, from the measurements to be carried out up to preparation of the documents can be conducted by Bürkert.

Hazardous Locations

Valves for ATEX Directives (formerly Explosion-Protection (EX) Directives) covers equipment, components and protection systems for use in hazardous areas. It also applies to safety facilities outside of hazardous areas if they are required for safe operation of equipment in the hazardous area with respect to the risk of explosion.



EDIP - The flexible solution for efficient processes

The digital revolution has brought about a high degree of process automation in production processes. Now Industry 4.0 is here with the second digitalization phase in which machines, sensors, actuators and people are networked with each other and can exchange information with each other. With EDIP – the Efficient Device Integration Platform – Bürkert opens up the world of intelligent networking for its products in this age of digitalization.

EDIP is the new device platform that unifies the operation, communication and interfaces of the process devices. The platform consists of the three components communication, software and hardware.

All future Bürkert field devices will be EDIP-based. Even today, the platform already offers numerous modules to make the intelligent networking simpler.



Online Analysis System: Modular system with a 7" touchscreen for monitoring the most important drinking water parameters at a glance.



Electromotive process control valve for use in demanding applications in systems without compressed air.



Fieldbus coupler: A multi-protocol module for integration of Bürkert field devices in industrial communication standards.



FLOWave: Innovative flow meter with no sensor elements in the measuring tube for hygienic applications.

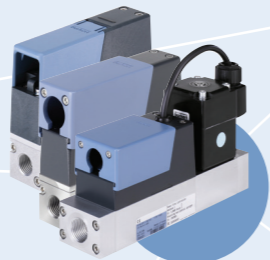

Compact mass flow controller/meter for precise gas control.



AirLINE: Valve island for the reliable control of process valves.



2-way proportional valve motor driven



ELEMENT control head and positioner

Your advantages at a glance

- Standardised control and display concept
- Fast and easy start-up
- Digital interface for access to detailed device diagnosis
- Quick and simple transfer of parameters to a new device via exchange of the storage medium
- Fast and reliable addition of new measurement functions
- Extensive options for connection to higher level controllers
- "Communicator" software tool for convenient programming of new functions via graphic user interface

Accessories

The most important criteria for selecting the right accessories for your pneumatic system are pressures, flow rates, materials for environmental resistance, port connection sizes, mounting options and tube lengths.

In particular, the following accessories should be used for configuring a complete pneumatic system:

- plastic tubes
- mufflers
- screwed fittings
- plug-in fittings
- compression fittings

Besides these pneumatic accessories, Bürkert offers a wide range of components such as flow valves and shut-off valves, which are interconnected with pilot valves and process valves, to form your pneumatic and process interface installation (see section “Selection Criteria for Multi-Way Valves” – page 36-37).



Added Value Systems

Bürkert has a unique perspective in the process control and instrumentation industry as we are the only single brand which combines a complete range of valves, instruments, pneumatic actuation, networking and controllers from a single source.

With our dedicated world-class engineers and our superlative manufacturing facilities we can deliver systems which meet your exact requirements.

Your reliable Bürkert sales consultant and our system engineers work in concert to ask the right questions and provide the right hardware. Transparent operations, up to date situation, review procedure, engineering change notices, portals through SAP and secure intranet are normal in our projects.

For a world class system experience, insist on Bürkert people to be part of your next project.



01

Connect

As a globally flexible, lean, focused and innovative company we are the partner of choice for fluid control systems in more than 35 countries. Whether you are in Stuttgart, Singapore, Chicago or Sydney, everywhere in the world, we are close to you and therefore know at first-hand about your specific tasks and problems.

Following our principle of "one face to the customer", you have a competent, reliable consultant by your side at all times, who listens to your needs and presents a solution in your daily application language ... crossing conventional boundaries and creating synergies between industries in pursuit of your ideal solution.

Systemhaus crews in Charlotte (USA), Suzhou (China), Dresden, Ingelfingen and Dortmund are continuously in innovation mode. They creatively engineer cost effective solutions to meet difficult process challenges for our customers.



02

Conceive & Innovate

Your project team starts working for you: from your reliable sales consultant, qualified industry specialists to dedicated system engineers – Bürkert puts the necessary experts together.

For the entire duration of the project they work together, combining their experience and clarifying all the requirements in close cooperation with you to come up with a feasible draft of your solution within the shortest timeframe.

CAD-created animations or simulations, combined with extended manufacturing, materials, tool design, construction and assembly knowledge enable us to provide a rough but firm production concept for your system at an early stage.



03

Plan & Specify

In Phase 3 the project is planned in detail. A specification sheet and refined solution concept are developed. This defines exactly what you expect from the system and what it must provide to ensure that all components meet your requirements.

At the end of this phase you are presented with a detailed product definition, a production specification and precise commercial conditions and agreements.

Structured project management based on open communication, effective coordination and thorough documentation ensures fast and reliable results.



04

Do & Check

Good communication, coordination and documentation at all project phases make sure that we are on the right track, developing the right solution, to allow us to quickly move on to prototyping.

Thanks to the latest technology, we are able to build a prototype made of metal or plastic or a functional model to test flow for example within 24 hours.

We provide you with samples; we perform tests and, of course, obtain all the necessary local and global approvals to make sure the system can go to production.

From here we work in concert with one of our production facilities in Ingelfingen, Gerabronn, Criesbach, Öhringen or Triembach according to their individual core manufacturing competencies.



05

Complete

Our work does not end with the perfect delivery of components and systems. We offer a comprehensive program to our global clients interlinking services ranging from maintenance and service contracts, operator training and integrated logistics.

Our customer service is available around the clock, offering support through internet, telephone or our qualified, experienced people at your site.

We aim to provide only the utmost in customer experience. Something you will tell your friends about.

Most Important Ingredient ... People

Perfect delivery of components and systems is one dimension in providing comprehensive solutions for our global clients. We offer a comprehensive program of interlinking services which include:

Personal Consultation and Individual Configurations

We share our knowledge both by embedding our expertise in the product and by really listening to your requirements with your success in mind. We are only content when your specific problem was solved.

Everything from one Partner

We have tens of thousands of process engineering products in our program. We know exactly how to program them, install them and combine them according to your wishes.

Customer Service around the Clock

We offer support through internet, telephone or people on the ground at your site. We are available around the clock.

Start-up

We are always available for installation and commissioning and local staff and operator training.

Global Operations

We are close by in 35 countries in a network which guarantees the full achievement of our enterprise to each customer on each continent.



Bürkert – Close to You

For up-to-date addresses
please visit us at
www.burkert.com.

