



— MODEL — 133-01

Metering Valve



- Automatically Measures and Controls Flow Rate Without a Separate Metering Device
- Completely Self Contained
- Reliable Analog Communications
- Retransmission Capabilities
- Ideal for Retrofitting Existing Valves
- Security System to Prevents Unauthorized Changes
- Optional Totalizing Capabilities

The Cla-Val Model 133-01 Metering Valve is a completely self contained valve and control system that accurately meters and/or controls flow rate when used on valves with pressure differentials of less than 100 psid.

Using a VC-22D Electronic Controller, data from valve mounted differential pressure and position transmitters are assimilated into a proprietary algorithm program that is based on valve size and configuration to arrive at a flow measurement. This information is used for retransmission and/or compared with a local or remote set-point for valve flow control.

The 133-01 Control System can also be installed on new or existing hydraulic pilot control valves such as: pressure reducing, pressure sustaining, flow limiting and level control to transmit flow rate without disturbing the valve's primary hydraulic function(s). Specify Kit 133-01 for these applications. Consult factory.

For all applications, specify voltage, minimum/maximum pressures and flow rates, valve size, pressure class and optional features. Consult your local representative or the Factory for engineering assistance and valve selection.

Schematic Diagram

Item	Description
1	100-01 Hytrol Main Valve
2	CS2S Solenoid Control
3	CK2 Solenoid By-Pass
4	VC-22D Electronic Controller
5	X117 Series Position Transmitter
6	DPT Differential Pressure Transmitter
7	CK2 Isolation Valve

Optional Features

Item	Description
A	X46A Flow Clean Strainer
B	CK2 Isolation Valve
C	CV Flow Control (Closing)
D	Check Feature
F	Independent Operation Pressure
H	Atmospheric Drain
P	X141 Pressure Gauge
S	CV Flow Control (Opening)
Y	X43 "Y" Strainer

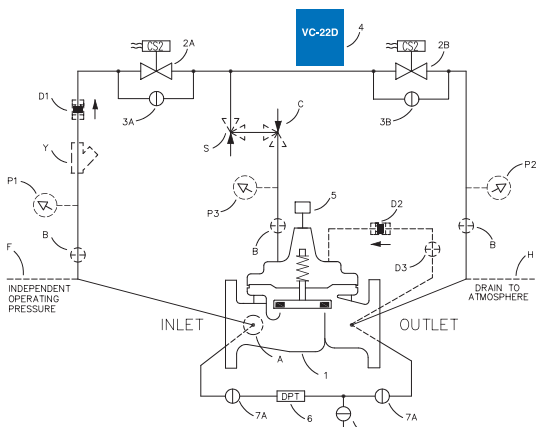

Typical Applications

The Model 133-01 Metering and Flow Rate Controller is typically installed in a fluid delivery system where the flow rate is measured and changed from a remote location such as a SCADA system.

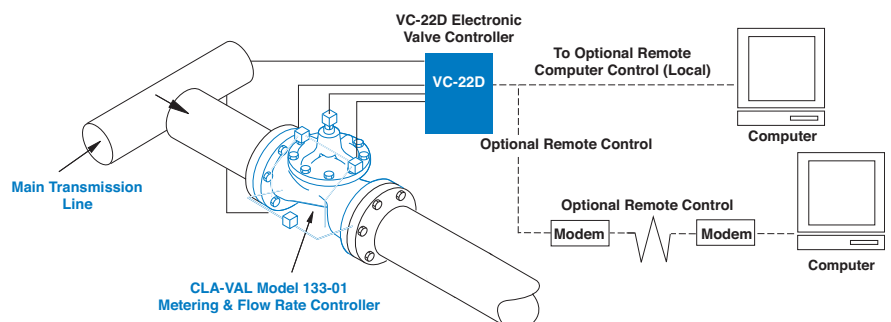

Model 133-01 (Uses 100-01 Hytrol Main Valve)

Pressure Ratings (Recommended Maximum Pressure - psi)

Valve Body & Cover		Pressure Class				
		Flanged			Grooved	Threaded
Grade	Material	ANSI Standards*	150 Class	300 Class	300 Class	End† Details
ASTM A536	Ductile Iron	B16.42	250	400	400	400
ASTM A216-WCB	Cast Steel	B16.5	285	400	400	400
UNS 87850	Bronze	B16.24	225	400	400	400

Note: * ANSI standards are for flange dimensions only.
 Flanged valves are available faced but not drilled.
 † End Details machined to ANSI B2.1 specifications.
Valves for higher pressure are available; consult factory for details

Materials

Component	Standard Material Combinations		
Body & Cover	Ductile Iron	Cast Steel	Bronze
Available Sizes	3" - 36" 80 - 900mm	3" - 16" 80 - 400mm	3" - 16" 80 - 400mm
Disc Retainer & Diaphragm Washer	Cast Iron	Cast Steel	Bronze
Trim: Disc Guide, Seat & Cover Bearing	Bronze is Standard Stainless Steel is Optional		
Disc	Buna-N® Rubber		
Diaphragm	Nylon Reinforced Buna-N® Rubber		
Stem, Nut & Spring	Stainless Steel		

For material options not listed, consult factory.
 Cla-Val manufactures valves in more than 50 different alloys.

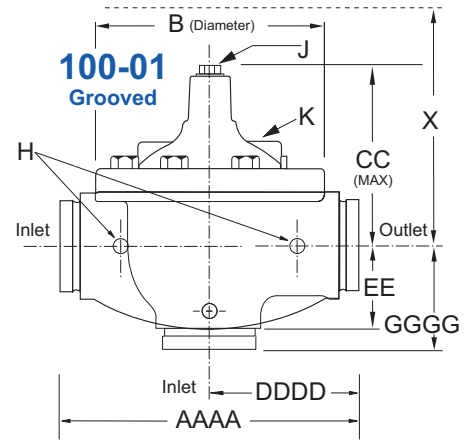
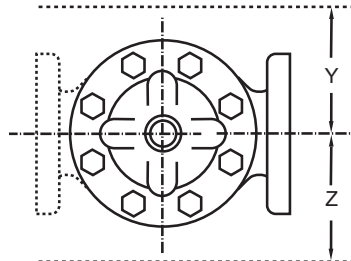
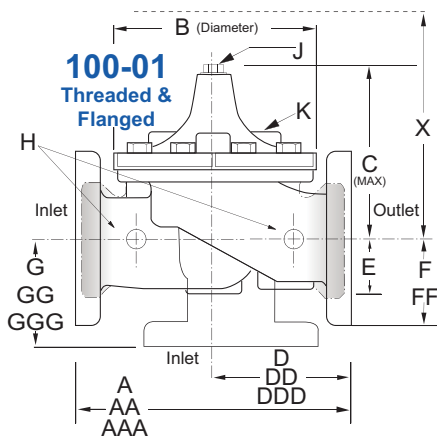

Model 133-01 Dimensions (Inches)

Valve Size (Inches)	3	4	6	8	10	12	14	16	18	20	24	30	36
A Threaded	12.50	—	—	—	—	—	—	—	—	—	—	—	—
AA 150 ANSI	12.00	15.00	20.00	25.38	29.75	34.00	39.00	41.38	46.00	52.00	61.50	63.00	72.75
AAA 300 ANSI	13.25	15.62	21.00	26.38	31.12	35.50	40.50	43.50	47.64	53.62	63.24	64.50	74.75
AAAA Grooved End	12.50	15.00	20.00	25.38	—	—	—	—	—	—	—	—	—
B Diameter	9.12	11.50	15.75	20.00	23.62	28.00	32.75	35.50	41.50	45.00	53.16	56.00	66.00
C Maximum	8.19	10.62	13.38	16.00	17.12	20.88	24.19	25.00	39.06	41.90	43.93	54.60	59.00
CC Maximum Grooved End	7.25	9.31	12.12	14.62	—	—	—	—	—	—	—	—	—
D Threaded	6.25	—	—	—	—	—	—	—	—	—	—	—	—
DD 150 ANSI	6.00	7.50	10.00	12.69	14.88	17.00	19.50	20.81	—	—	30.75	—	—
DDD 300 ANSI	6.38	7.88	10.50	13.25	15.56	17.75	20.25	21.62	—	—	31.62	—	—
DDDD Grooved End	6.00	7.50	—	—	—	—	—	—	—	—	—	—	—
E	2.06	3.19	4.31	5.31	9.25	10.75	12.62	15.50	12.95	15.00	17.75	21.31	24.56
EE Grooved End	3.12	4.25	6.00	7.56	—	—	—	—	—	—	—	—	—
F 150 ANSI	3.75	4.50	5.50	6.75	8.00	9.50	10.50	11.75	15.00	16.50	19.25	22.50	28.50
FF 300 ANSI	4.13	5.00	6.25	7.50	8.75	10.25	11.50	12.75	15.00	16.50	19.25	24.00	30.00
G Threaded	4.50	—	—	—	—	—	—	—	—	—	—	—	—
GG 150 ANSI	4.00	5.00	6.00	8.00	8.62	13.75	14.88	15.69	—	—	22.06	—	—
GGG 300 ANSI	4.38	5.31	6.50	8.50	9.31	14.50	15.62	16.50	—	—	22.90	—	—
GGGG Grooved End	4.25	5.00	—	—	—	—	—	—	—	—	—	—	—
H NPT Body Tapping	0.50	0.75	0.75	1.00	1.00	1.00	1.00	1.00	1.00	1.00	1.00	2.00	2.00
J NPT Cover Center Plug	0.50	0.75	0.75	1.00	1.00	1.25	1.50	2.00	1.00	1.00	1.00	2.00	2.00
K NPT Cover Tapping	0.50	0.75	0.75	1.00	1.00	1.00	1.00	1.00	1.00	1.00	1.00	2.00	2.00
Stem Travel	0.80	1.10	1.70	2.30	2.80	3.40	4.00	4.50	5.10	5.63	6.75	7.50	8.50
Approx. Ship Weight (lbs)	70	140	285	500	780	1165	1600	2265	2982	3900	6200	7703	11720
Approx. X Pilot System	15	17	29	31	33	36	40	40	43	47	68	79	85
Approx. Y Pilot System	11	12	20	22	24	26	29	30	32	34	39	40	45
Approx. Z Pilot System	11	12	20	22	24	26	29	30	32	34	39	42	47

Model 133-01 Metric Dimensions (Uses 100-01 Hytrol Main Valve)

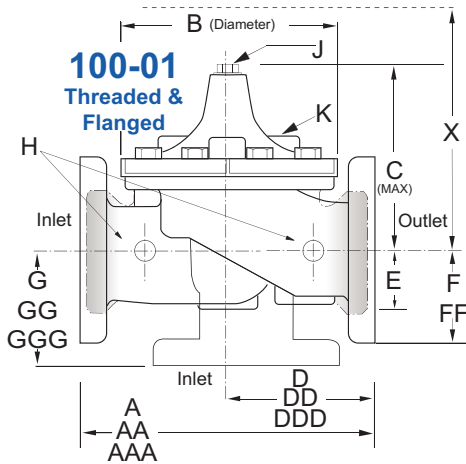
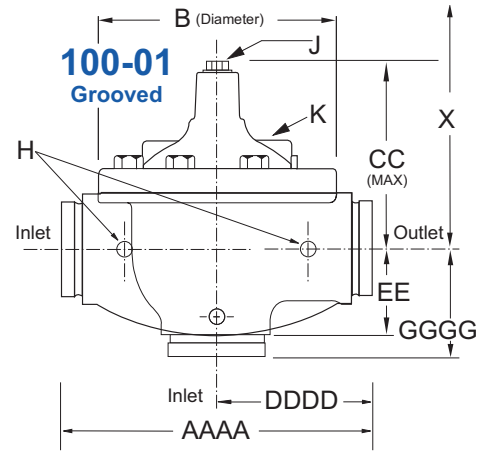
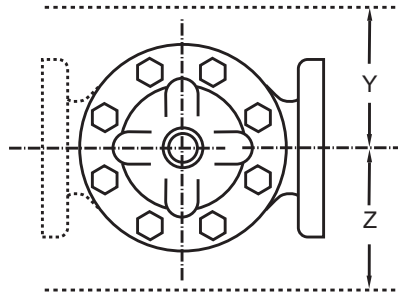

Model 133-01 Dimensions (mm)

Valve Size (mm)	80	100	150	200	250	300	350	400	450	500	600	750	900
A Threaded	318	—	—	—	—	—	—	—	—	—	—	—	—
AA 150 ANSI	305	381	508	645	756	864	991	1051	1168	1321	1562	1600	1848
AAA 300 ANSI	337	397	533	670	790	902	1029	1105	1210	1326	1606	1638	1899
AAAA Grooved End	318	381	508	645	—	—	—	—	—	—	—	—	—
B Diameter	232	292	400	508	600	711	832	902	1054	1143	1350	1422	1676
C Maximum	208	270	340	406	435	530	614	635	992	1064	1116	1387	1499
CC Maximum Grooved End	184	236	308	371	—	—	—	—	—	—	—	—	—
D Threaded	159	—	—	—	—	—	—	—	—	—	—	—	—
DD 150 ANSI	152	191	254	322	378	432	495	528	—	—	781	—	—
DDD 300 ANSI	162	200	267	337	395	451	514	549	—	—	803	—	—
DDDD Grooved End	152	191	—	—	—	—	—	—	—	—	—	—	—
E	52	81	110	135	235	273	321	394	329	381	451	541	624
EE Grooved End	79	108	152	192	—	—	—	—	—	—	—	—	—
F 150 ANSI	95	114	140	171	203	241	267	298	381	419	489	572	724
FF 300 ANSI	105	127	159	191	222	260	292	324	381	419	489	610	762
G Threaded	114	—	—	—	—	—	—	—	—	—	—	—	—
GG 150 ANSI	102	127	152	203	219	349	378	399	—	—	560	—	—
GGG 300 ANSI	111	135	165	216	236	368	397	419	—	—	582	—	—
GGGG Grooved End	108	127	—	—	—	—	—	—	—	—	—	—	—
H NPT Body Tapping	0.50	0.75	0.75	1.00	1.00	1.00	1.00	1.00	1.00	1.00	1.00	2.00	2.00
J NPT Cover Center Plug	0.50	0.75	0.75	1.00	1.00	1.25	1.50	2.00	1.00	1.00	1.00	2.00	2.00
K NPT Cover Tapping	0.50	0.75	0.75	1.00	1.00	1.00	1.00	1.00	1.00	1.00	1.00	2.00	2.00
Stem Travel	20	28	43	58	71	86	102	114	130	143	171	190	216
Approx. Ship Weight (kgs)	32	64	129	227	354	528	726	1027	1353	1769	2812	3494	5316
Approx. X Pilot System	381	432	737	788	839	915	1016	1016	1093	1194	1728	2007	2159
Approx. Y Pilot System	280	305	508	559	610	661	737	762	813	864	991	1016	1143
Approx. Z Pilot System	280	305	508	559	610	661	737	762	813	864	991	1067	1194

133-01 Valve Selection	100-01 Pattern: Globe (G), Angle (A), End Connections: Threaded (T), Grooved (GR), Flanged (F) Indicate Available Sizes													
	Inches	3	4	6	8	10	12	14	16	18	20	24	30	36
	mm	80	100	150	200	250	300	350	400	450	500	600	750	900
Main Valve 100-01	Pattern	G, A	G, A	G, A	G, A	G, A	G, A	G, A	G, A	G	G	G, A	G	G
	End Detail	T, F, Gr	F, Gr	F, Gr*	F, Gr*	F	F	F	F	F	F	F	F	F
Suggested Flow (gpm)	Maximum	460	800	1800	3100	4900	7000	8400	11000	14000	17000	25000	42000	50000
	Maximum Intermittent	580	990	2250	3900	6150	8720	10540	13700	17500	21700	31300	48000	62500
Suggested Flow (Liters/Sec)	Maximum	29	50	113	195	309	442	530	694	883	1073	1577	2650	3150
	Maximum Intermittent	37	62	142	246	387	549	664	863	1104	1369	1972	3028	3940

100-01 Series is the full internal port Hytrol. *Globe Grooved Only

Pilot System Specifications*

Temperature Range

Water: to 180°F / 82°C

Rubber Parts:

Buna-N® Rubber Synthetic

Solenoid Control

Body: Brass ASTM B283

Enclosure: NEMA Type 1,2,3,3S,4,4X general purpose watertight
NEMA Type 6,6P,7,9 watertight explosion proof available

Voltage: 24, 120, 240, 480 - 60Hz AC
24 - DC

Max. operating pressure differential:
100 psi

Coil:

Insulation Molded Class	F
Watts AC	6
AC Volt Amps Inrush	30
AC Volt Amps Holding	16
Watts DC	10.6

*For specifications on other 133 Series Valves, please consult factory. The 133-01 is shown.

When Ordering, Specify

1. Catalog No. 133-01
2. Valve Size
3. Pattern - Globe or Angle
4. Pressure Class
5. Threaded or Flanged
6. Trim Material
7. Electrical Specifications
8. Desired Options
9. When Vertically Installed

Valve Options

X141
Pressure
Gauge



X101AR Valve
Position Indicator
with Air Release



X101
Valve Position
Indicator



X144 e-FlowMeter



X43H
Strainer



Stainless
Steel Pilot



E-133-01 with VC-22D Controller
(R-03/2021)

CLA-VAL

1701 Placentia Avenue • Costa Mesa, CA 92627
800-942-6326 • Web Site: www.cla-val.com • E-mail: info@cla-val.com

CLA-VAL CANADA
4687 Christie Drive
Beamsville, Ontario
Canada L0R 1B4
Phone: 905-563-4963
www.cla-val.com
E-mail: sales@cla-val.ca

CLA-VAL EUROPE
Chemin des Mésanges 1
CH-1032 Romanel/
Lausanne, Switzerland
Phone: 41-21-643-15-55
www.cla-val.ch
E-mail: info@cla-val.ch

CLA-VAL UK
Dainton House, Goods Station Road
Tunbridge Wells
Kent TN1 2 DH England
Phone: 44-1892-514-400
www.cla-val.ch
E-mail: info@cla-val.co.uk

CLA-VAL FRANCE
Porte du Grand Lyon 1
ZAC du Champ du Périer
France - 01700 Neyron
Phone: 33-4-72-25-92-93
www.cla-val.ch
E-mail: info@cla-val.ch

CLA-VAL ASIA PACIFIC
45 Kennaway Road
Woolston, Christchurch, 8023
New Zealand
Phone: 64-39644860
www.cla-valpacific.com
E-mail: info@cla-valpacific.com

© COPYRIGHT CLA-VAL 2021 Printed in USA. Specifications subject to change without notice.

visit www.cla-val-latinamerica.com for Spanish literature