



Series 33AWS

Sizes 1" - 2" - 3" - 4" - 6"

Well Service Combination Air Release & Vacuum Breaker Valve



Threaded



Flanged

- Full Unrestricted Air Vacuum Protection
- Permits Regulating Volume of Air Discharge From Vertical Turbine Well Pump
- Standard Maximum Operating Pressure 300 psi
- Standard Epoxy Coated Ductile Iron Body
- Easily Serviced
- Tested to Seal at 2 psi
- 1" - 4" Standard with Throttling Device
- Arrestor Check Available on 4" and 6"
- Meets AWWA C512 Requirements

33AWS Well Service Air Valves regulate air discharge from the pump column to prevent shock and air entering the system with each start. Conversely with each pump stop, full flow unrestricted air, is allowed back into the column preventing vacuum forming, which can damage pump seals, but also to prevent the pump restarting against a full head in the column because vacuum will prevent the pump column to drain. Under this condition severe damage to the pump, controls and piping can occur.

All the preceding is accomplished by means of a unique air throttling device (double port) and an arrestor check with built in anti-shock feature.

Well service air vacuum valves, once closed and pressured do not open to air release under pressure.

Installation

Series 33AWS Well Service Valve is typically installed between the pump discharge and check valve. Mount the unit in the vertical position on top of the pipeline with an isolation valve installed below the valve in the event servicing is required.

Provide adequate air venting inside the pump station and from air valve vaults on pipelines.

Operation

Air Release Mode—Valve is normally open.

When line is filled or pump started, air is exhausted through the normally open 33AWS valve. As liquid fills the valve, float ball rises to form a drip-tight closure and remaining air is exhausted through small orifice.

Vacuum Prevent Mode When line pressure drops below positive pressure and the liquid level lowers, the float drops, unseating the valve and allowing air into the line, thus preventing a vacuum.

Note: Available for Sea Water Service See Material Specifications

Typical Applications

- Vertical Turbine Pump Discharge
- Transmission Pipeline High Points
- Water Treatment Plant Piping High Points

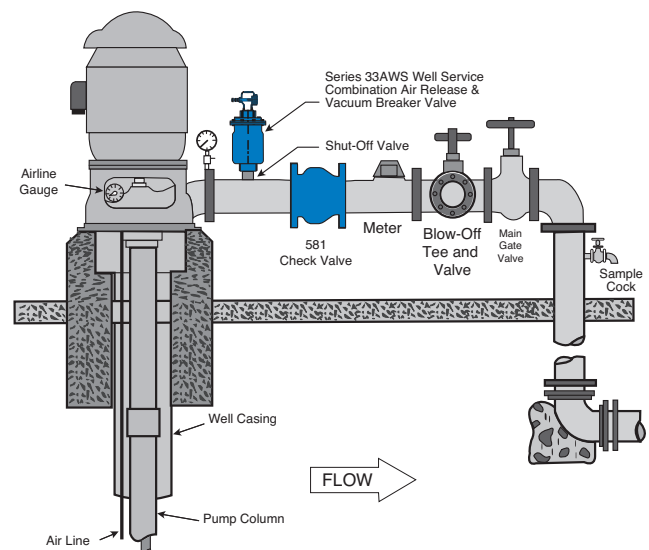

MODEL 33AWS Sizes - 1" - 2" - 3" - 4" - 6"

Threaded Inlet 1" - 4"

Threaded 33AWS Well Service Valves are supplied with air throttling devices. These devices permit regulating the volume of air discharge from the vertical pump column thereby to cushion the shock from the rising water column, as it impacts against a closed pump, discharge check valve or control valve. By utilizing this type of air valve, damage to the vertical turbine pump, piping, and controls will be prevented. Field adjustment of this air throttling device is simple and requires no special tools.

Flanged Inlet 4" and 6"

For Flanged 33AWS Well Service Valves supplied with Arrestor Checks, the device functions to stop the flow of water, (for a fraction of a second) entering the upper chamber of the air valve. The Arrestor Check then opens instantly, water enters the air valve, all air is exhausted and the air valve shuts. This Arrestor Check action allows for a slow non shock air valve shut-off. To prevent pump or pipeline damage the shut-off/open action of the arrestor check occurs instantaneously. It is self regulating and requires no adjustment in the field. Arrestor Check air valves are recommended at high points where velocities approach 10' / second in the main line.

Valve Size	33AWSTD Pressure Class 300 Lb Threaded X Threaded				33AWSTD Pressure Class 150 Lb Threaded X Flanged			33AWSAC Pressure Class 150 Lb Threaded X Flanged		33AWSTDAC Pressure Class 150 Lb Threaded X Flanged
	1"	2"	3"	4"	2"	3"	4"	4"	6"	4"
A	12.50	16.50	18.50	20.00	17.75	21.75	23.50	23.00	25.38	30.75
B	6.25	7.50	9.25	9.25	7.50	9.25	9.25	9.25	11.50	9.25
Inlet (ANSI)	1" NPT	2" NPT	3" NPT	4" NPT	2"	3"	4"	4"	6"	6"
Outlet (NPT)	1" NPT	2" NPT	3" NPT	4" NPT	2" NPT	3" NPT	4" NPT	4" NPT	6" NPT	4" NPT
Number of Holes	—	—	—	—	4	4	8	8	—	8"
Diameter of Bolts	—	—	—	—	0.63	0.63	0.75	0.75	—	0.75
Shipping Wt. (Lb.)	33	40	45	50	45	50	55	95	130	110

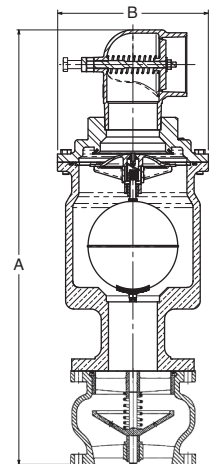
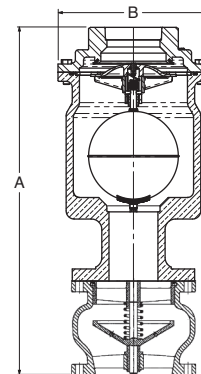
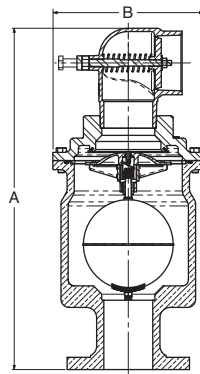
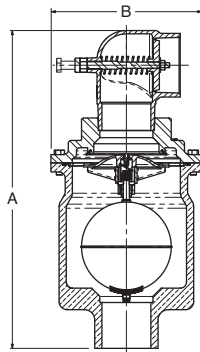

Pressure Ratings

Size	Orifice Dia.	Std Max. Pressure	Materials of Construction
1"	.076"	300 psi	<ul style="list-style-type: none"> Epoxy Coated Ductile Iron ASTM A536 65-45-12 Epoxy Coated Cast Steel ASTM A 216WCB
2"	.076"	300 psi	
3" & 4"	.125"	300 psi	<ul style="list-style-type: none"> ASTM B61 Naval Bronze ASTM B 148 NI Aluminum Bronze 316 Stainless Steel
3" & 4"	.076"	300 psi	
6"	.076"	300 psi	<ul style="list-style-type: none"> Duplex Stainless Steel Super Duplex Stainless Steel Bronze

Note: Higher Pressures Available upon Request for sizes 2", 3", & 4"

Specifications

Standard Internals

Float: Stainless Steel 304SS Standard,
Optional T316 or Monel

Seals: Nitrile Rubber or Optional Viton®

Remainder of Internal Components:
Stainless Steel and Delrin

Temperature Range

Water to 180° F

Optional:

- Goose Neck available 1" - 4"
- Arrestor Check 4" and 6"

Valve Sizing Selection

Large Orifice Vacuum Capacity

Determine anticipated water flow and allowable pressure differential for the pipeline application. Select valve from chart to exhaust or admit air at the same rate as water filling or draining (in CFS). For larger flows, two or more Model 33A's may be installed in parallel

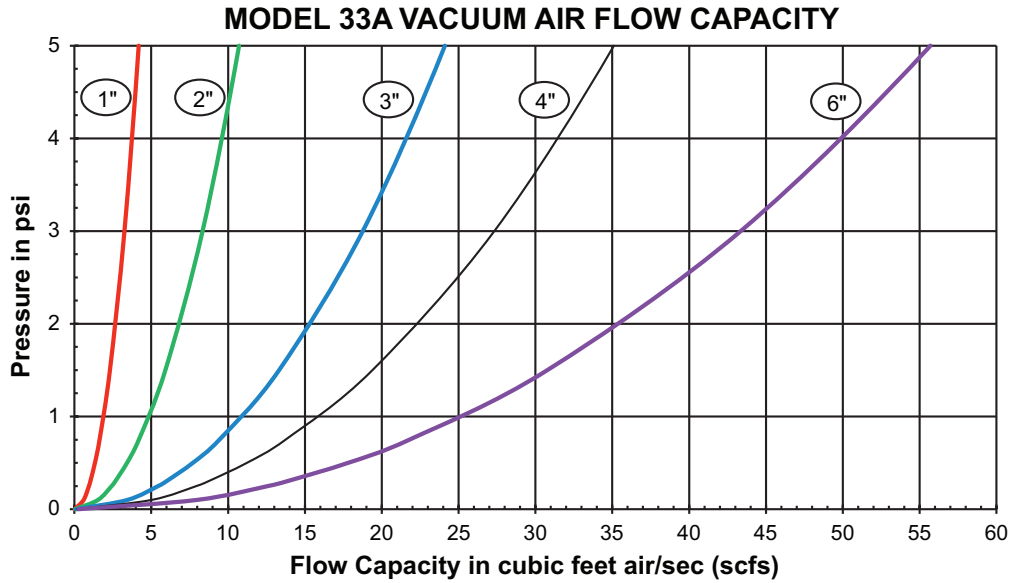

Small Orifice Capacity - Air Release

During pressurized pipeline operation, small pockets of entrapped air will be released through the float actuated 0.076 or .125 inch orifice. Use chart to determine discharge capacity.

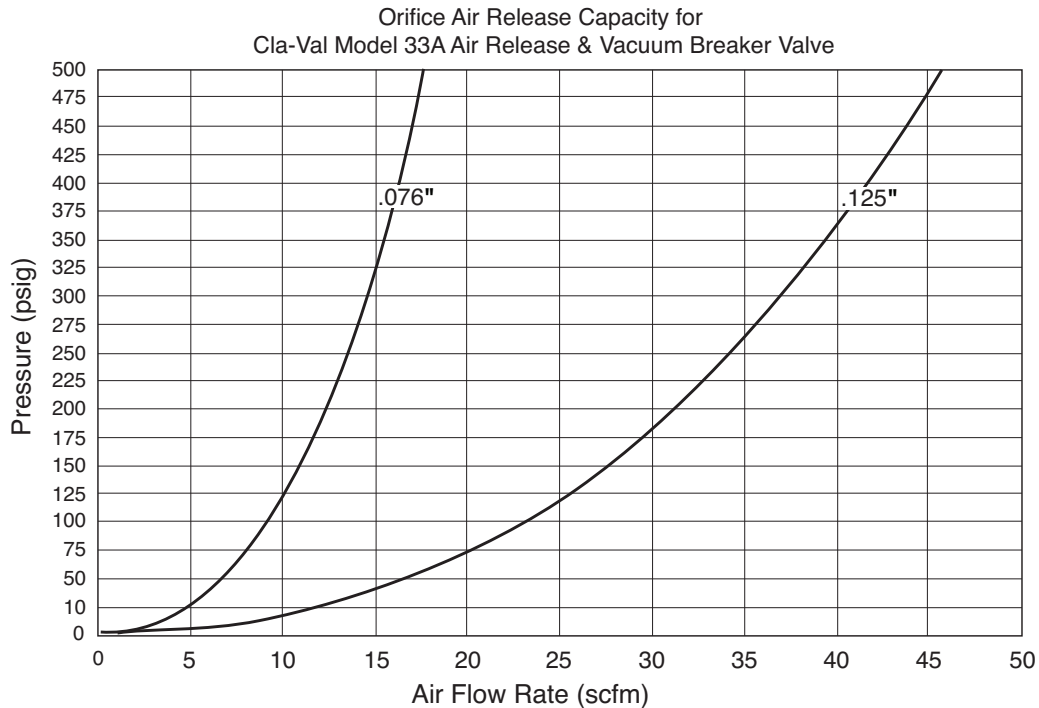



Throttling Device

- Full unrestricted air vacuum protection
- Permits regulating volume of air discharge from vertical turbine well pump
- Adjustable orifice for air exhaust with locking nut
- Full spring loaded vacuum break intake
- Standard Epoxy Coated Ductile Iron
- Retrofit existing 33A



Arrestor Check

- Prevents premature closure and water hammer
- Recommended for pipeline and vertical turbine applications
- Retrofit existing 33A
- Standard Epoxy Coated Ductile Iron
- Removable internal plugs for closing speed control

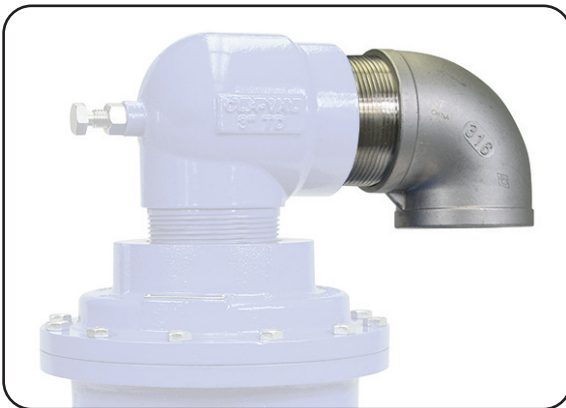

Goose Neck

- Redirect exhaust spray
- Can be combined with Throttling Device

When Ordering, Specify:

1. Catalog No. 33AWS
2. Valve Size
3. Pressure Class
4. Materials



1701 Placentia Avenue • Costa Mesa, CA 92627
 800-942-6326 • Web Site: www.cla-val.com • E-mail: info@cla-val.com

CLA-VAL CANADA
 4687 Christie Drive
 Beamsville, Ontario
 Canada L0R 1B4
 Phone: 905-563-4963
www.cla-val.com
 E-mail: sales@cla-val.ca

CLA-VAL EUROPE
 Chemin des Mésanges 1
 CH-1032 Romanel/
 Lausanne, Switzerland
 Phone: 41-21-643-15-55
www.cla-val.ch
 E-mail: info@cla-val.ch

CLA-VAL UK
 Dainton House, Goods Station Road
 Tunbridge Wells
 Kent TN1 2 DH England
 Phone: 44-1892-514-400
www.cla-val.ch
 E-mail: info@cla-val.co.uk

CLA-VAL FRANCE
 Porte du Grand Lyon 1
 ZAC du Champ du Pérrier
 France - 01700 Neyron
 Phone: 33-4-72-25-92-93
www.cla-val.ch
 E-mail: info@cla-val.ch

CLA-VAL ASIA PACIFIC
 45 Kennaway Road
 Woolston, Christchurch, 8023
 New Zealand
 Phone: 64-39644860
www.cla-valpacific.com
 E-mail: info@cla-valpacific.com

© COPYRIGHT CLA-VAL 2021 Printed in USA Specifications subject to change without notice.

visit www.cla-val-latinamerica.com for Spanish literature

E-33AWS (R-01/2021)