



— MODEL — **390-07**

# Electronic Actuated Pressure Reducing Valve



- Simplified, electronic remote valve set point control
- Ideal for use with VC-22D Electronic Valve Controller
- Use to adjust pressure set points to save water
- Isolated input
- 12-24 VDC Input Power
- Reverse Polarity Protection
- Submersible (IP-68)

The Cla-Val Model 390-07 Electronic Actuated Pressure Reducing Control Valve with Manual Hydraulic Bypass combines precise control of field proven Cla-Val hydraulic pilots and simple, remote valve control. The Cla-Val Model 390-07 Pressure Reducing Valve automatically reduces a higher inlet pressure to a steady lower downstream pressure regardless of changing flow rate and/or varying inlet pressure. This valve is an accurate, pilot-operated regulator capable of holding downstream pressure to a pre-determined limit. The valve uses a CRD-34 pilot control, consisting of a hydraulic pilot and integral controller, that accepts a remote set-point command input and makes set-point adjustments to the pilot.

### Schematic Diagram

Item	Description
1	100-01 Hytrol Main Valve
2	X58C Restriction Fitting
3	CRD-34 Electronic Pressure Reducing Control
4	CRD Pressure Reducing Control
5	CK2 Isolation Valve

### Optional Features

Item	Description
A	X46A Flow Clean Strainer
B	CK2 Isolation Valve
C	CV Flow Control (Closing)
D	Check Valves with Isolation Valve
P	X141 Pressure Gauge
S	CV Flow Control (Opening)
V	X101 Valve Position Indicator
Y	X43 "Y" Strainer

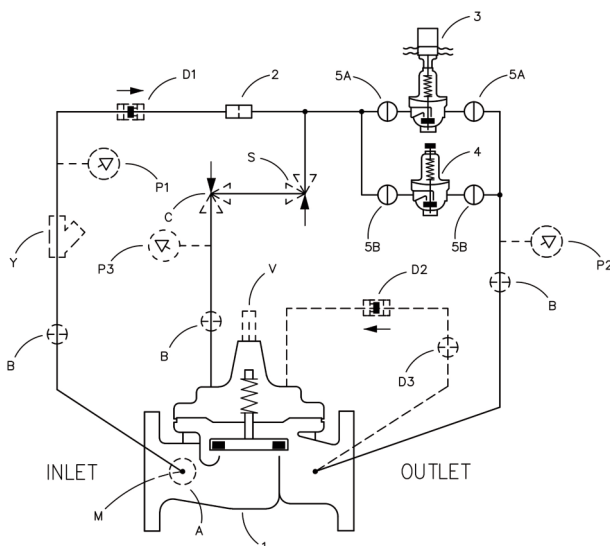

The recommended control method is simple remote set-point change from an RTU (Remote Telemetry Unit) to the CRD-34 where the 4-20 mA command signal is ranged to specific pressure range. Very accurate control can be achieved when span does not exceed 100 psi. Since the CRD-34 is pre-ranged to the full spring range, some on-site calibration may be necessary when this control method is used. Free downloadable software is available from Cla-Val website for this purpose. The CRD-34 can also accommodate control systems where the RTU compares pressure transmitter signal to the remote set point command signal. The RTU adjusts the CRD-34 with 4-20 mA command signal containing an adequate deadband to prevent actuator dithering after the two signals agree.

Internal continuous electronic monitoring of actuator position results in virtually instantaneous position change with no backlash or dithering when control signal is changed. In the event of a power or control input failure, the CRD-34 pilot remains in hydraulic control virtually assuring system stability under changing conditions. If check feature ("D") is added, and pressure reversal occurs, the valve closes to prevent return flow. During SCADA startup and maintenance the manually-adjusted CRD pilot control allows automatic hydraulic valve operation when no electric power is available for CRD-34.

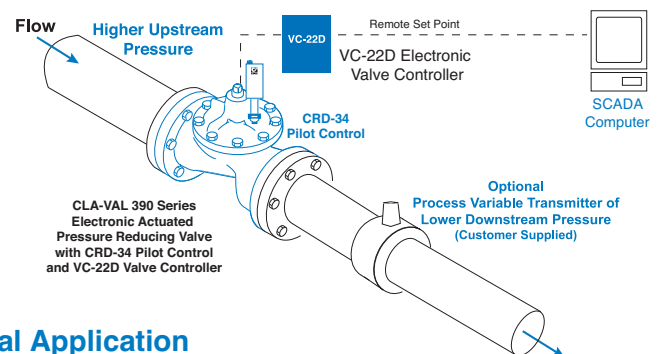

### Typical Application

The Cla-Val 390 Series valves that maintain downstream pressure and require this pressure to be changed from a remote location. It can be an effective solution for lowering costs associated with "confined space" requirements by eliminating the need for entry in valve structure for set-point adjustment. It is also ideal for pressure management, and can be programmed to minimum night time and optimum daytime pressures.

## Model 390-07 (Uses Hytrol Main Valve 100-01)

### Pressure Ratings (Recommended Maximum Pressure - psi)

Valve Body & Cover		Pressure Class				
		Flanged			Grooved	Threaded
Grade	Material	ANSI Standards*	150 Class	300 Class	300 Class	End‡ Details
ASTM A536	Ductile Iron	B16.42	250	400	400	400
ASTM A216-WCB	Cast Steel	B16.5	285	400	400	400
UNS 87850	Bronze	B16.24	225	400	400	400

Note: \* ANSI standards are for flange dimensions only.  
 Flanged valves are available faced but not drilled.  
 ‡ End Details machined to ANSI B2.1 specifications.  
**Valves for higher pressure are available; consult factory for details**

### Materials

Component	Standard Material Combinations		
Body & Cover	Ductile Iron	Cast Steel	Bronze
Available Sizes (inches)	1" - 36"	1" - 16"	1" - 16"
Available Sizes (mm)	25 - 900 mm	25 - 400 mm	25 - 400 mm
Disc Retainer & Diaphragm Washer	Cast Iron	Cast Steel	Bronze
Trim: Disc Guide, Seat & Cover Bearing	Bronze is Standard Stainless Steel is Optional		
Disc	Buna-N® Rubber		
Diaphragm	Nylon Reinforced Buna-N® Rubber		
Stem, Nut & Spring	Stainless Steel		

For material options not listed, consult factory.  
 Cla-Val manufactures valves in more than 50 different alloys.

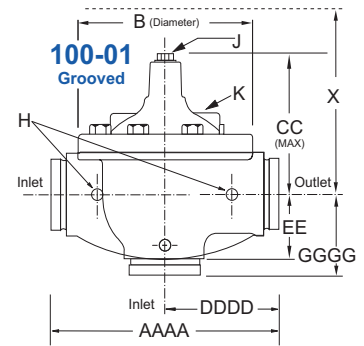
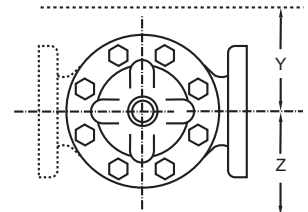
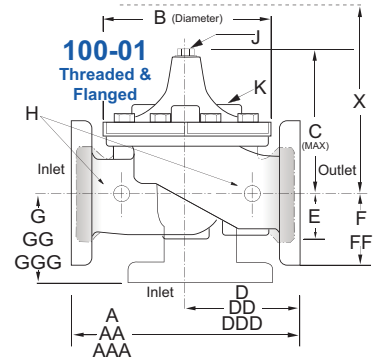

### Model 390-07 Dimensions (inches)

Valve Size (Inches)	1	1 1/4	1 1/2	2	2 1/2	3	4	6	8	10	12	14	16	18	20	24	30	36
A Threaded	7.25	7.25	7.25	9.38	11.00	12.50	—	—	—	—	—	—	—	—	—	—	—	—
AA 150 ANSI	—	—	8.50	9.38	11.00	12.00	15.00	20.00	25.38	29.75	34.00	39.00	41.38	46.00	52.00	61.50	63.00	72.75
AAA 300 ANSI	—	—	9.00	10.00	11.62	13.25	15.62	21.00	26.38	31.12	35.50	40.50	43.50	47.64	53.62	63.24	64.50	74.75
AAAA Grooved End	—	—	8.50	9.00	11.00	12.50	15.00	20.00	25.38	—	—	—	—	—	—	—	—	—
B Diameter	5.62	5.62	5.62	6.62	8.00	9.12	11.50	15.75	20.00	23.62	28.00	32.75	35.50	41.50	45.00	53.16	56.00	66.00
C Maximum	5.50	5.50	5.50	6.50	7.56	8.19	10.62	13.38	16.00	17.12	20.88	24.19	25.00	39.06	41.90	43.93	54.60	59.00
CC Maximum Grooved End	—	—	4.75	5.75	6.88	7.25	9.31	12.12	14.62	—	—	—	—	—	—	—	—	—
D Threaded	3.25	3.25	3.25	4.75	5.50	6.25	—	—	—	—	—	—	—	—	—	—	—	—
DD 150 ANSI	—	—	4.00	4.75	5.50	6.00	7.50	10.00	12.69	14.88	17.00	19.50	20.81	—	—	30.75	—	—
DDD 300 ANSI	—	—	4.25	5.00	5.88	6.38	7.88	10.50	13.25	15.56	17.75	20.25	21.62	—	—	31.62	—	—
DDDD Grooved End	—	—	—	4.75	—	6.00	7.50	—	—	—	—	—	—	—	—	—	—	—
E	1.12	1.12	1.12	1.50	1.69	2.06	3.19	4.31	5.31	9.25	10.75	12.62	15.50	12.95	15.00	17.75	21.31	24.56
EE Grooved End	—	—	2.00	2.50	2.88	3.12	4.25	6.00	7.56	—	—	—	—	—	—	—	—	—
F 150 ANSI	—	—	2.50	3.00	3.50	3.75	4.50	5.50	6.75	8.00	9.50	10.50	11.75	15.00	16.50	19.25	22.50	28.50
FF 300 ANSI	—	—	3.06	3.25	3.75	4.13	5.00	6.25	7.50	8.75	10.25	11.50	12.75	15.00	16.50	19.25	24.00	30.00
G Threaded	1.88	1.88	1.88	3.25	4.00	4.50	—	—	—	—	—	—	—	—	—	—	—	—
GG 150 ANSI	—	—	4.00	3.25	4.00	4.00	5.00	6.00	8.00	8.62	13.75	14.88	15.69	—	—	22.06	—	—
GGG 300 ANSI	—	—	4.25	3.50	4.31	4.38	5.31	6.50	8.50	9.31	14.50	15.62	16.50	—	—	22.90	—	—
GGGG Grooved End	—	—	—	3.25	—	4.25	5.00	—	—	—	—	—	—	—	—	—	—	—
H NPT Body Tapping	0.375	0.375	0.375	0.375	0.50	0.50	0.75	0.75	1.00	1.00	1.00	1.00	1.00	1.00	1.00	1.00	2.00	2.00
J NPT Cover Center Plug	0.25	0.25	0.25	0.50	0.50	0.50	0.75	0.75	1.00	1.00	1.25	1.50	2.00	1.00	1.00	1.00	2.00	2.00
K NPT Cover Tapping	0.375	0.375	0.375	0.375	0.50	0.50	0.75	0.75	1.00	1.00	1.00	1.00	1.00	1.00	1.00	1.00	2.00	2.00
Stem Travel	0.40	0.40	0.40	0.60	0.70	0.80	1.10	1.70	2.30	2.80	3.40	4.00	4.50	5.10	5.63	6.75	7.50	8.50
Approx. Ship Weight (lbs)	15	15	15	35	50	70	140	285	500	780	1165	1600	2265	2982	3900	6200	7703	11720
Approx. X Pilot System	11	11	11	13	14	15	17	29	31	33	36	40	40	43	47	68	79	85
Approx. Y Pilot System	9	9	9	9	10	11	12	20	22	24	26	29	30	32	34	39	40	45
Approx. Z Pilot System	9	9	9	9	10	11	12	20	22	24	26	29	30	32	34	39	42	47

Note: The top two flange holes on valve size 36 are threaded to 1 1/2"-6 UNC.

## Model 390-07 Metric Dimensions (Uses Main Valve Model 100-01)

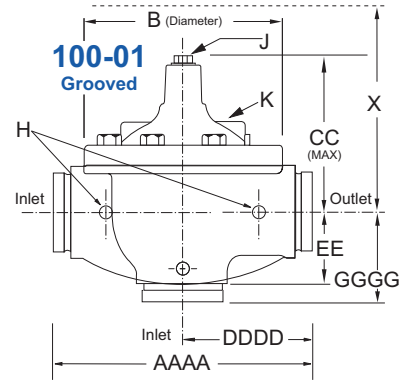
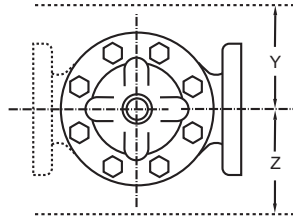
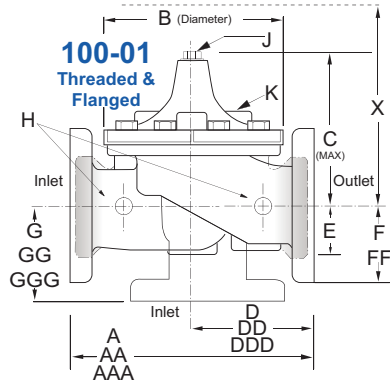

Valve Size (mm)	25	32	40	50	65	80	100	150	200	250	300	350	400	450	500	600	750	900
A Threaded	184	184	184	238	279	318	—	—	—	—	—	—	—	—	—	—	—	—
AA 150 ANSI	—	—	216	238	279	305	381	508	645	756	864	991	1051	1168	1321	1562	1600	1848
AAA 300 ANSI	—	—	229	254	295	337	397	533	670	790	902	1029	1105	1210	1326	1606	1638	1899
AAAA Grooved End	—	—	216	228	279	318	381	508	645	—	—	—	—	—	—	—	—	—
B Diameter	143	143	143	168	203	232	292	400	508	600	711	832	902	1054	1143	1350	1422	1676
C Maximum	140	140	140	165	192	208	270	340	406	435	530	614	635	992	1064	1116	1387	1499
CC Maximum Grooved End	—	—	120	146	175	184	236	308	371	—	—	—	—	—	—	—	—	—
D Threaded	83	83	83	121	140	159	—	—	—	—	—	—	—	—	—	—	—	—
DD 150 ANSI	—	—	102	121	140	152	191	254	322	378	432	495	528	—	—	781	—	—
DDD 300 ANSI	—	—	108	127	149	162	200	267	337	395	451	514	549	—	—	803	—	—
DDDD Grooved End	—	—	—	121	—	152	191	—	—	—	—	—	—	—	—	—	—	—
E	29	29	29	38	43	52	81	110	135	235	273	321	394	329	381	451	541	624
EE Grooved End	—	—	52	64	73	79	108	152	192	—	—	—	—	—	—	—	—	—
F 150 ANSI	—	—	64	76	89	95	114	140	171	203	241	267	298	381	419	489	572	724
FF 300 ANSI	—	—	78	83	95	105	127	159	191	222	260	292	324	381	419	489	610	762
G Threaded	48	48	48	83	102	114	—	—	—	—	—	—	—	—	—	—	—	—
GG 150 ANSI	—	—	102	83	102	102	127	152	203	219	349	378	399	—	—	560	—	—
GGG 300 ANSI	—	—	102	89	110	111	135	165	216	236	368	397	419	—	—	582	—	—
GGGG Grooved End	—	—	—	83	—	108	127	—	—	—	—	—	—	—	—	—	—	—
H NPT Body Tapping	0.375	0.375	0.375	0.375	0.50	0.50	0.75	0.75	1.00	1.00	1.00	1.00	1.00	1.00	1.00	1.00	2.00	2.00
J NPT Cover Center Plug	0.25	0.25	0.25	0.50	0.50	0.50	0.75	0.75	1.00	1.00	1.25	1.50	2.00	1.00	1.00	1.00	2.00	2.00
K NPT Cover Tapping	0.375	0.375	0.375	0.375	0.50	0.50	0.75	0.75	1.00	1.00	1.00	1.00	1.00	1.00	1.00	1.00	2.00	2.00
Stem Travel	10	10	10	15	18	20	28	43	58	71	86	102	114	130	143	171	190	216
Approx. Ship Weight (kgs)	7	7	7	16	23	32	64	129	227	354	528	726	1027	1353	1769	2812	3494	5316
Approx. X Pilot System	280	280	280	331	356	381	432	737	788	839	915	1016	1016	1093	1194	1728	2007	2159
Approx. Y Pilot System	229	229	229	229	254	280	305	508	559	610	661	737	762	813	864	991	1016	1143
Approx. Z Pilot System	229	229	229	229	254	280	305	508	559	610	661	737	762	813	864	991	1067	1194



### Valve Options

X141 Pressure Gauge



X144 e-FlowMeter



X101AR Valve Position Indicator with Air Release



X101 Valve Position Indicator



X43H Strainer



Stainless Steel Pilot

390-07 Valve Selection	100-01 Pattern: Globe (G), Angle (A), End Connections: Threaded (T), Grooved (GR), Flanged (F) Indicate Available Sizes																		
	Inches	1	1¼	1½	2	2½	3	4	6	8	10	12	14	16	18	20	24	30	36
	mm	25	32	40	50	65	80	100	150	200	250	300	350	400	450	500	600	750	900
Main Valve 100-01	Pattern	G, A	G, A	G, A	G, A	G, A	G, A	G, A	G, A	G, A	G, A	G, A	G, A	G, A	G	G	G, A	G	G
	End Detail	T	T	T, F, Gr*	T, F, Gr	T, F, Gr*	T, F, Gr	F, Gr	F, Gr*	F, Gr*	F	F	F	F	F	F	F	F	F
Suggested Flow (gpm)	Maximum	55	93	125	210	300	460	800	1800	3100	4900	7000	8400	11000	14000	17000	25000	42000	50000
	Maximum Intermittent	68	120	160	260	370	580	990	2250	3900	6150	8720	10540	13700	17500	21700	31300	48000	62500
	Minimum	1	1	1	1	2	2	4	10	15	35	50	70	95	120	150	275	450	650
Suggested Flow (Liters/Sec)	Maximum	3.5	6	8	13	19	29	50	113	195	309	442	530	694	883	1073	1577	2650	3150
	Maximum Intermittent	4.3	7.6	10	16	23	37	62	142	246	387	549	664	863	1104	1369	1972	3028	3940
	Minimum	.03	.03	.03	.06	.09	0.13	0.25	0.63	0.95	2.2	3.2	4.4	6.0	7.6	9.5	17.4	28.4	41.0

100-01 Series is the full internal port Hytrol.

For Lower Flows Consult Factory

\*Globe Grooved Only

We recommend providing adequate space around valve for maintenance work



### CRD-34 Overview

The Cla-Val Model CRD-34 and CRA-34 Electronic Actuated Pressure Reducing Pilot Controls provide remote set-point adjustment and accurate downstream pressure control on Cla-Val 390 Series Control Valves. Remote set-point command signals can be from any SCADA-type control system using an analog 4-20 mA signal, by contact closure for cc/ccw rotation or through Modbus RTU.

The CRD-34 senses valve outlet pressure directly and the CRA-34 senses downstream pressure with remote hydraulic connection. Operating on 12 - 24 VDC and consuming very little power, they are an ideal control system for remote valve sites that may even be solar powered. Existing manually-set Cla-Val 90 Series Pressure Reducing control valves can be retrofitted with CRD-34 or CRA-34 to add remote set-point control of delivery pressure. Verification of downstream pressure may be sent to SCADA system from customer supplied pressure sensor attached to valve outlet.

### CRD-34 Subassembly Specifications

#### Adjustment Ranges

- 2 to 30 psi
- 15 to 75 psi
- 20 to 105 psi
- 40 to 140 psi

#### End Connection

3/8" NPT

#### Temperature Range

Water: to 180°F

#### Materials

- Pilot Control: Low Lead Bronze
- Trim: Stainless Steel Type 303
- Rubber: Buna-N® Synthetic Rubber

Available with optional Stainless Steel or Monel materials. Consult factory for details.

Note: Available with remote sensing control (specify CRA-34)

### When Ordering, Specify:

- |                             |                              |
|-----------------------------|------------------------------|
| 1. Catalog No. 390-07       | 6. Trim Material             |
| 2. Valve Size               | 7. Adjustment Range          |
| 3. Pattern - Globe or Angle | 8. Desired Options           |
| 4. Pressure Class           | 9. When Vertically Installed |
| 5. Threaded or Flanged      |                              |

### CRD-34 Actuator Specifications

#### Supply Power Input:

- 12 to 24 VDC
- No Load draw: 50 mA
- Max. Load draw: 250 mA

#### Remote Command Inputs:

- 4-20mA, analog signal (isolated and reverse-polarity protected)
- Dry contact closure (CW/CCW)

#### Position Feedback Signal:

4-20 mA

#### Alarm Output:

Dry-contact closure (High/Low)

#### Speed of Rotation:

Adjustable On/Off time, max 6 rpm

#### Diagnostic:

LED Indicator

#### Loss of Power:

Actuator will remain in last commanded position.

#### Loss of Signal Position:

Programmable - 4 mA, Last, or 20 mA

#### Electrical Connections:

Single, 30 feet of permanently attached cable with color-coded power supply and signal wires

#### Mechanical Specifications:

Environmental

- Protection Class: IP-68 (Temporary submersible)
- Ambient Temperature: 15° to 150° F (-10° to 65° C)

#### Materials

- Electronics Enclosure: Anodized Aluminum
- Mechanical Housing: Bronze
- Coupling Assembly: Stainless Steel
- Gear Train: Stainless Steel, permanently lubricated