

STAN-COR

*ANSI, solid Kynar or Teflon
non-metallic centrifugal pumps*



***50 Hz Pump Performance Curves,
Selection and Specifications***

Stan-Cor Pump Selection

Contents

Kynar Pump Curves	3-12
Kynar Pump Dimensions	13
Teflon Pump Curves	14
Teflon Pump Dimensions	15
Design Considerations	16-17
Warranty	18

Use the selection information below and the chart on the following page to determine the appropriate Stan-Cor pump model and size for your application, then use the detailed Performance Curves inside for model specific performance curves.

Please contact Wanner Engineering or your local Stan-Cor distributor for any assistance you may need in sizing a Stan-Cor pump to your specific application.

Kynar Pump Selection

Series-ANSI Code	Pump Size	Capacity Speed	Capacity L/min	Total Head Meters	Curve #	Page
PST-AA	1-1/2 x 1 x 6	1450	230	9	1085	3
PST-AA	1-1/2 x 1 x 6	2900	430	35	1086	3
PST-AB	3 x 1-1/2 x 6	1450	430	7	1087	4
PST-AB	3 x 1-1/2 x 6	2900	900	30	1088	4
PST-A50M	3 x 1-1/2 x 9	1450	825	18	1089	5
PST-A50L	3 x 1-1/2 x 9	1450	675	17	1090	6
PST-A50L	3 x 1-1/2 x 9	2900	950	68	1091	6
PST-A60M	3 x 2 x 9	970	700	8	1092	7
PST-A60M	3 x 2 x 9	1450	850	18	1093	7
PST-A60L	3 x 2 x 9	1450	1100	18	1094	8
PST-A60L	3 x 2 x 9	2900	1300	70	1095	8
PST-A70M	4 x 3 x 9	970	1500	9	1096	9
PST-A70M	4 x 3 x 9	1450	1900	18	1097	9
PST-A70L	4 x 3 x 9	1450	1900	18	1098	10
PST-A70L	4 x 3 x 9	2900	2100	75	1099	10
PST-A30	3 x 2 x 12	970	900	14	1128	11
PST-A30	3 x 2 x 12	1450	1150	32	1129	11
PST-A40	4 x 3 x 12	970	1850	15	1130	12
PST-A40	4 x 3 x 12	1450	2000	33	1131	12

Teflon Pump Selection

Series-ANSI Code	Pump Size	Capacity Speed	Capacity L/min	Total Head Meters	Curve #	Page
PST-AB-TFE	3 x 1-1/2 x 6	1450	430	7	1087	14
PST-A50M-TFE	3 x 1-1/2 x 9	1450	825	18	1089	14
PST-A70M-TFE	4 x 3 x 9	1450	1900	18	CONSULT FACTORY	

Group 1, 2 and 3 Comparison

Stan-Cor Pumps are offered in three performance groups.

Group	Kynar Models	Teflon Models	Shaft Ø @ Seal	Shaft Ø @ Coupling
1	PST-AA		1-3/8"	7/8"
	PST-AB		1-3/8"	7/8"
		PST-AB-TFE	1-1/2"	7/8"
2	PST-A50M		1-7/8"	1-1/8"
		PST-A50M-TFE	2"	1-1/8"
	PST-A60M		1-7/8"	1-1/8"
	PST-A70M		1-7/8"	1-1/8"
		PST-A70M-TFE	2"	1-1/8"
		PST-A30		1-7/8"
3	PST-A40		1-7/8"	1-1/8"
	PST-A50L		2-1/4"	1-1/8"
	PST-A60L		2-1/4"	1-1/8"
	PST-A70L		2-1/4"	1-1/8"

Group 1 Bearing Frame: 1-3/8" @ Seal

● 1450 RPM

● Curve #1085

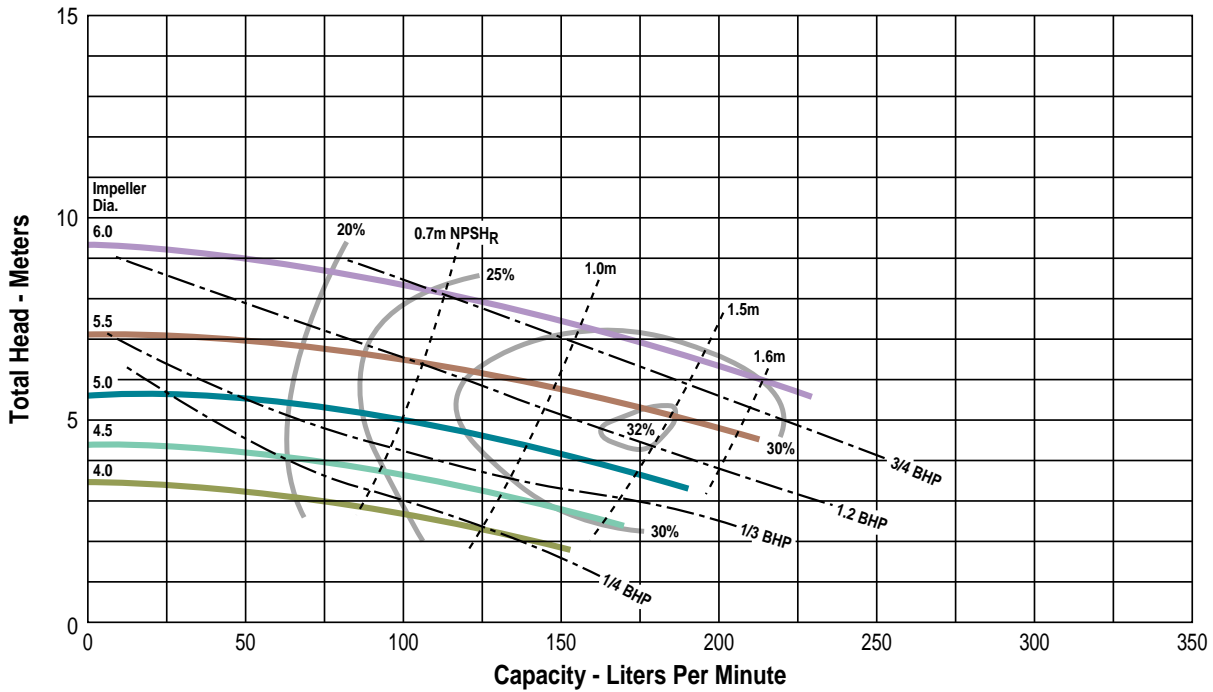

● 2900 RPM

● Curve #1086

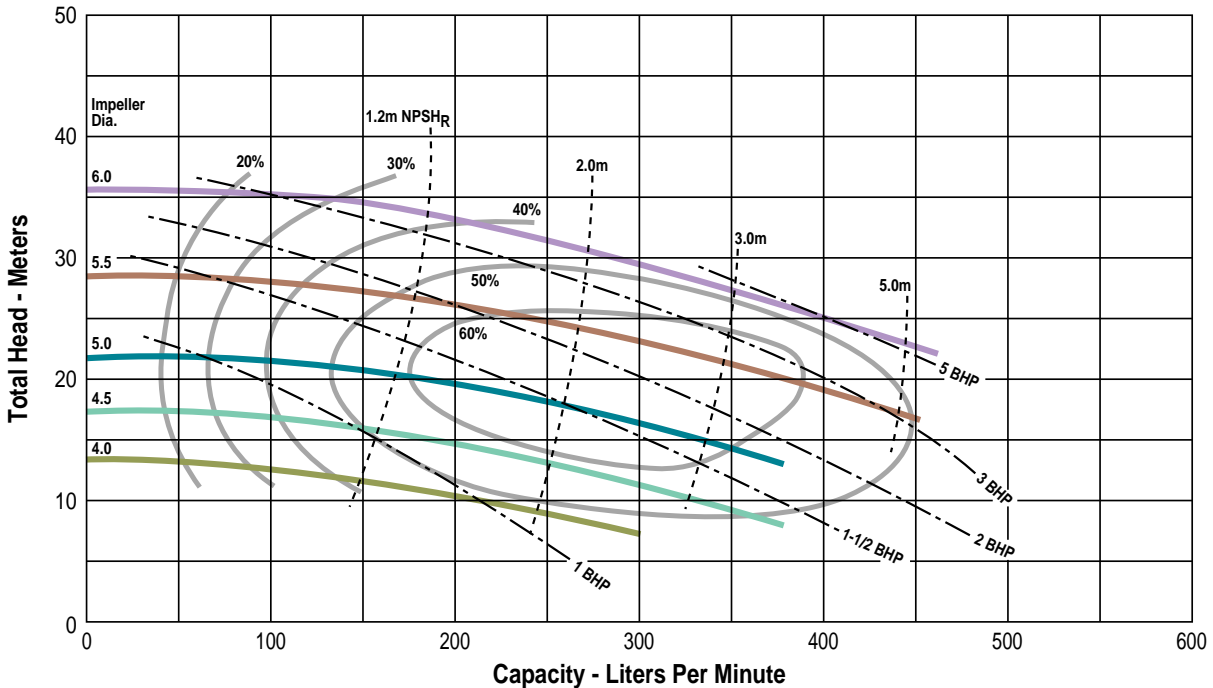

KYNNAR

KYNNAR

Group 1 Bearing Frame: 1-3/8" @ Seal

• 1450 RPM

• Curve #1087

KYNAR

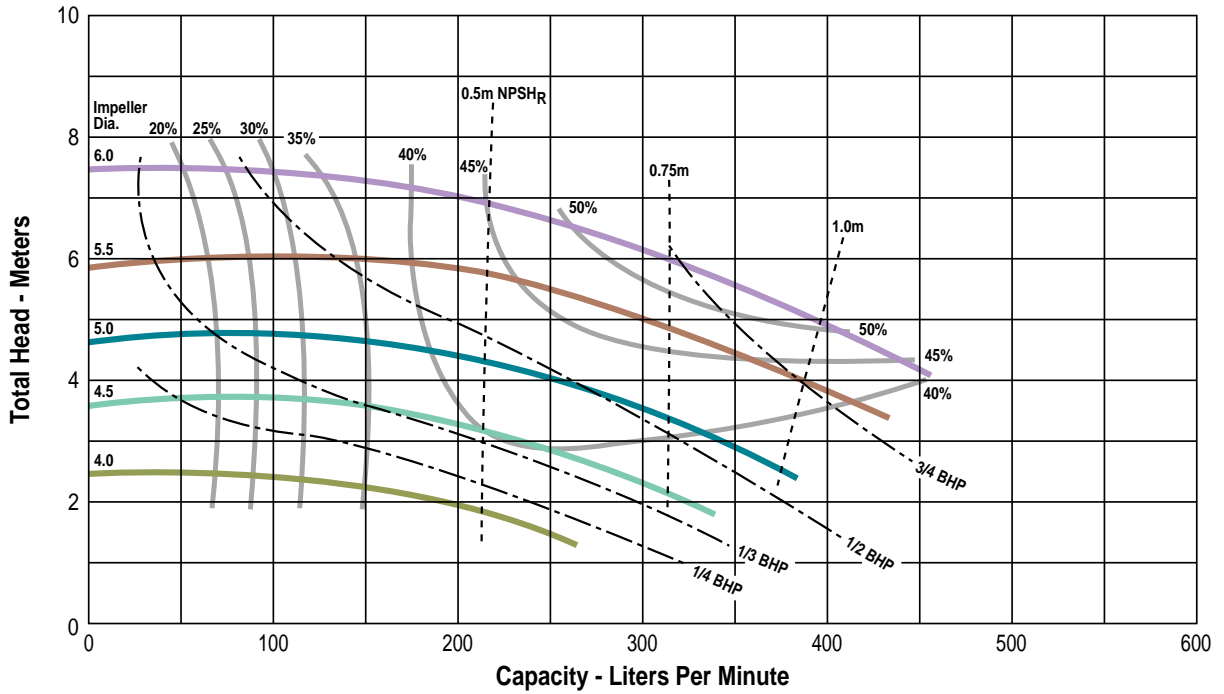

• 2900 RPM

• Curve #1088

KYNAR

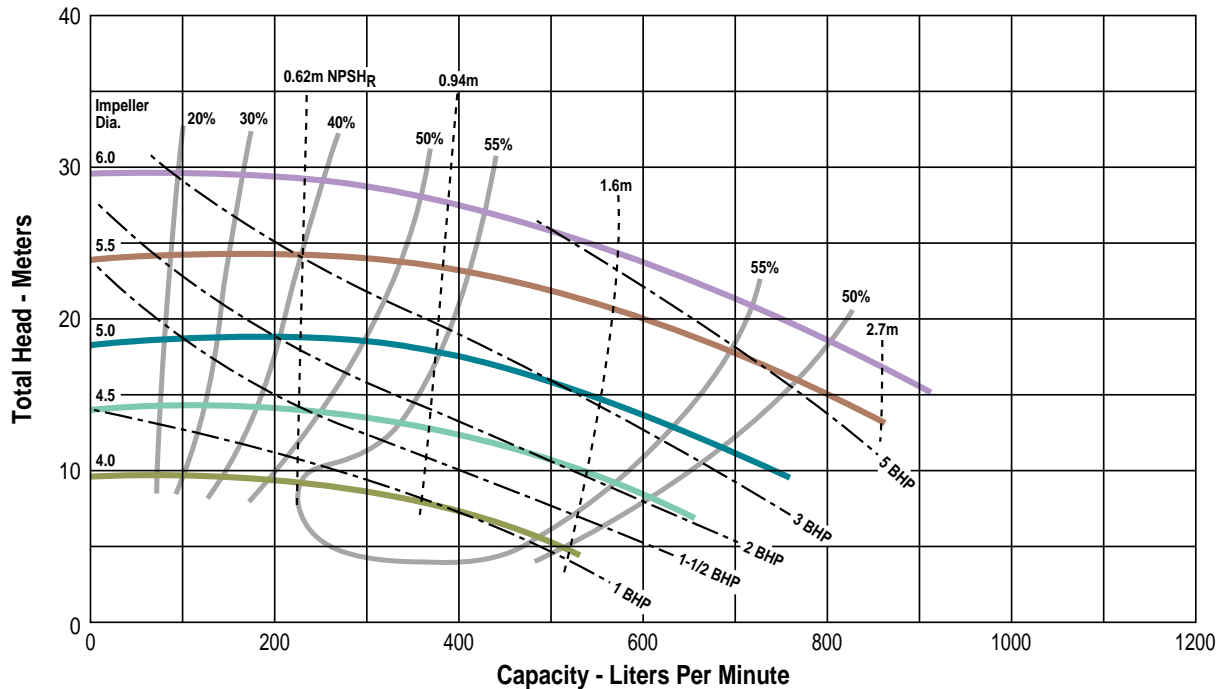

Group 2 Bearing Frame: 1-7/8" @ Seal

● 1450 RPM

● Curve #1089

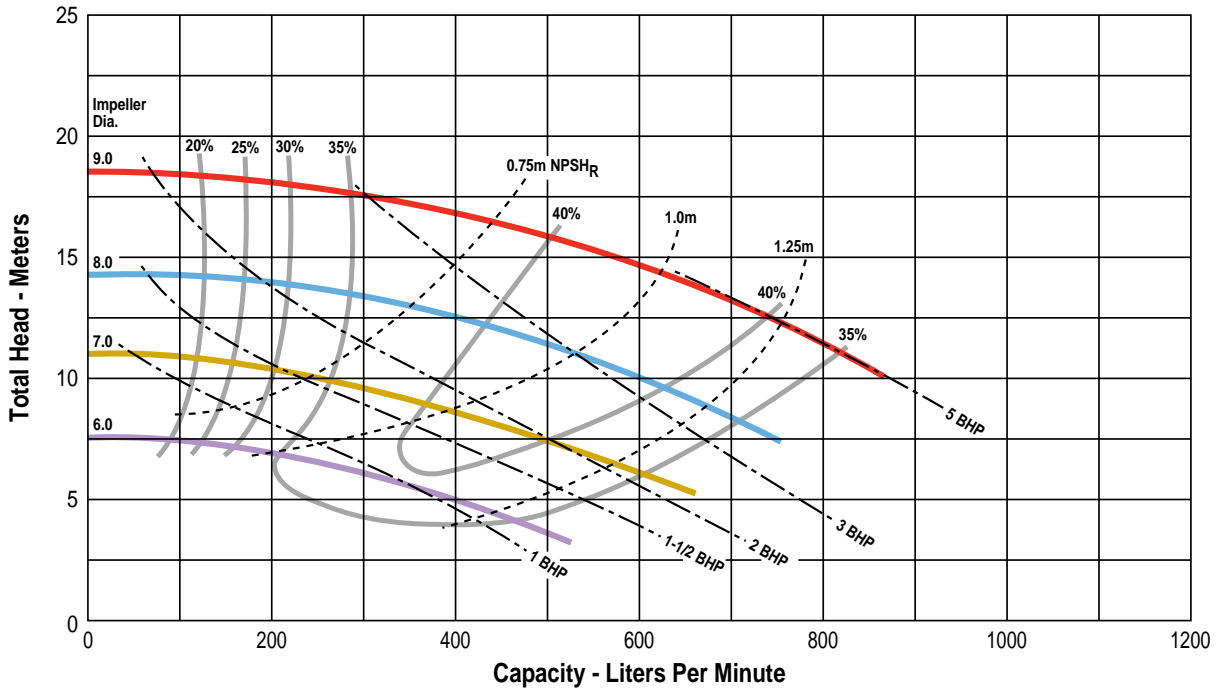

KYMAR

KYMAR

Group 3 Bearing Frame: 2-1/4" @ Seal

● 1450 RPM

● Curve #1090

KYNAR

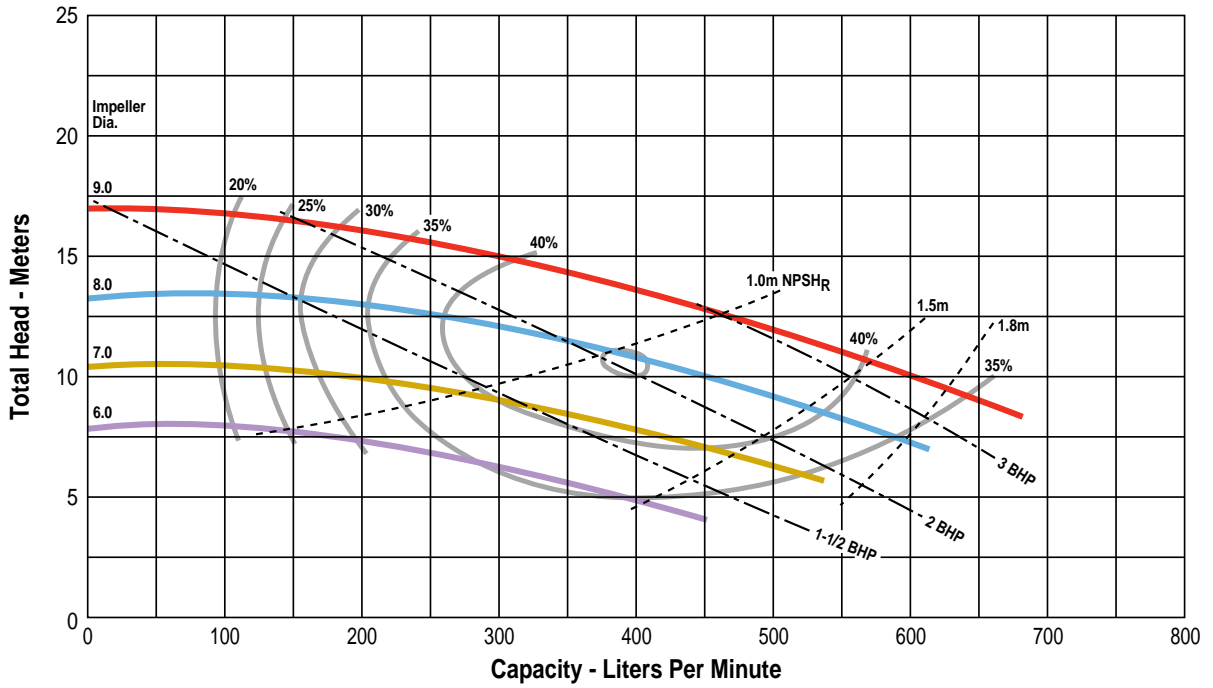

● 2900 RPM

● Curve #1091

KYNAR

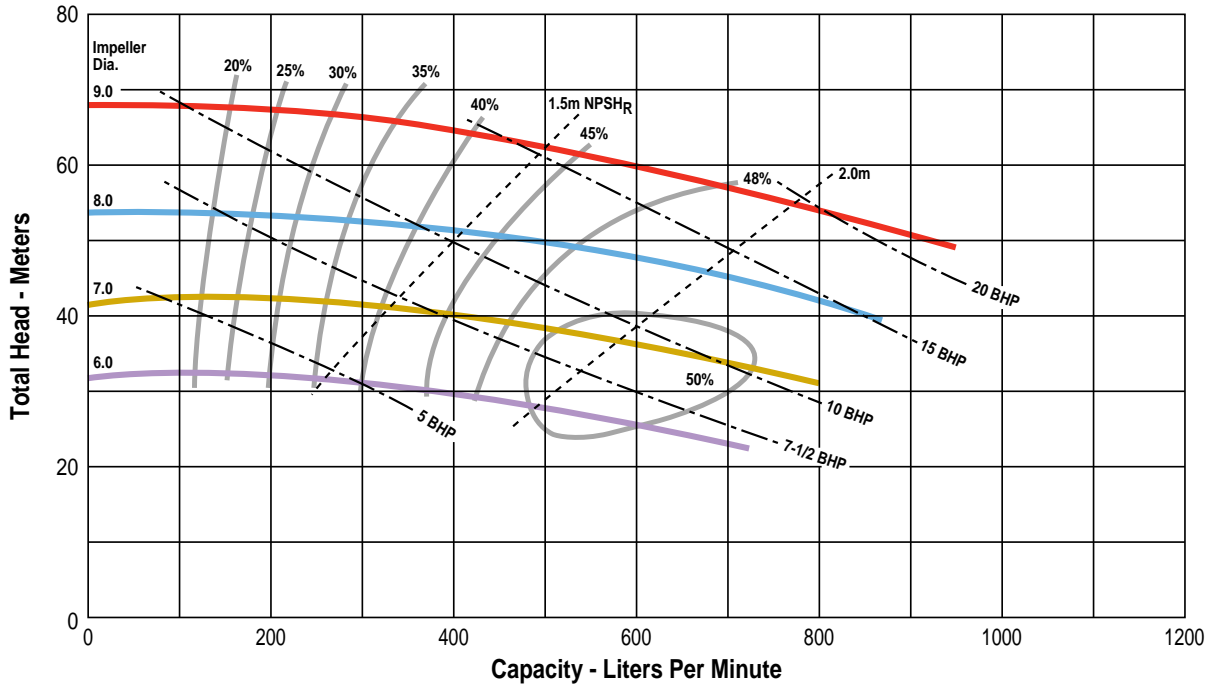

Group 2 Bearing Frame: 1-7/8" @ Seal

● **970 RPM**

● **Curve #1092**

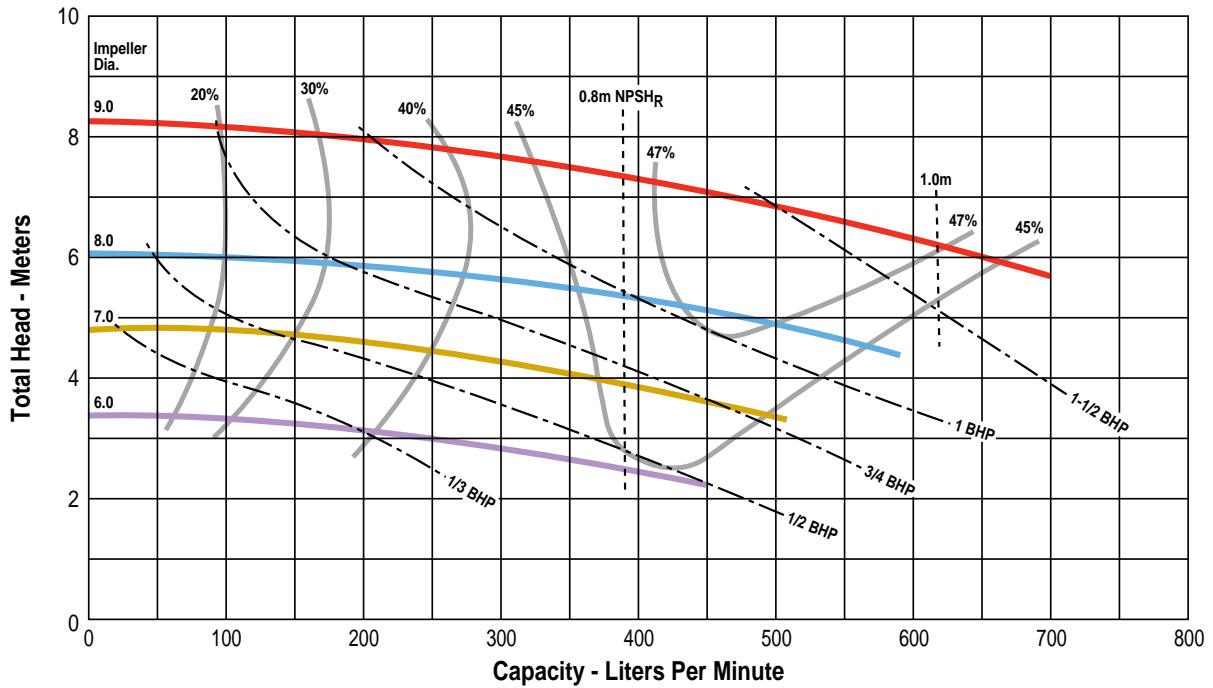

KYNNAR

● **1450 RPM**

● **Curve #1093**

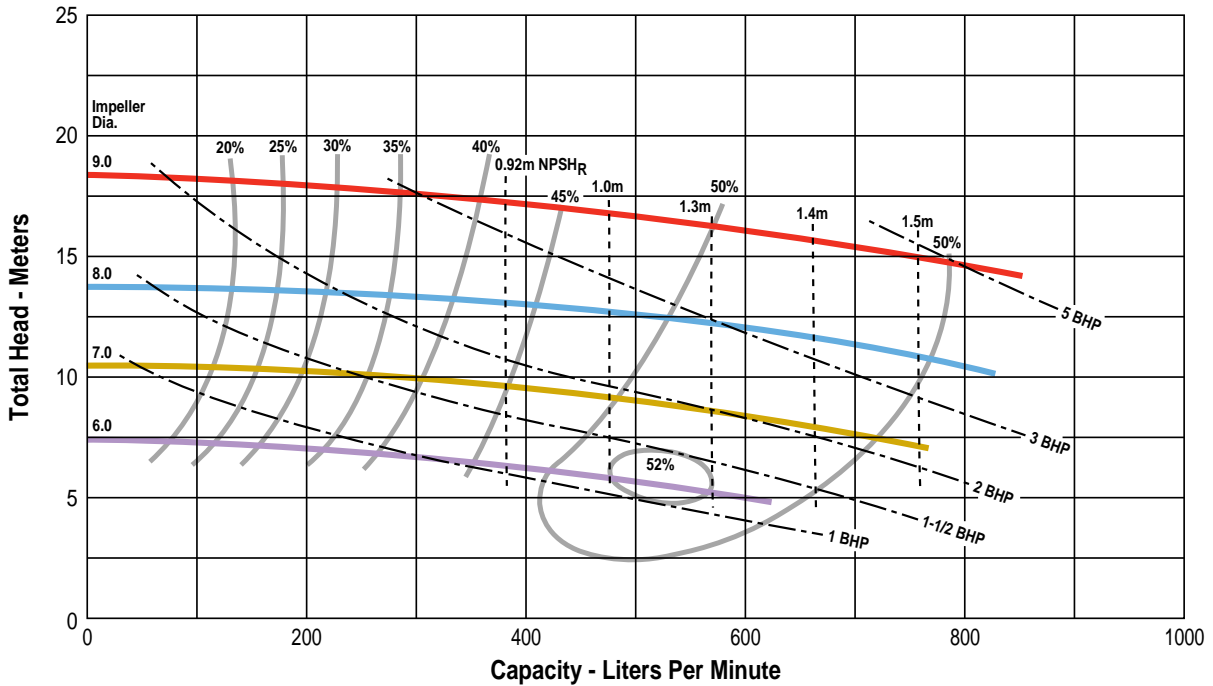

KYNNAR

Group 3 Bearing Frame: 2-1/4" @ Seal

• 1450 RPM

• Curve #1094

KYNAR

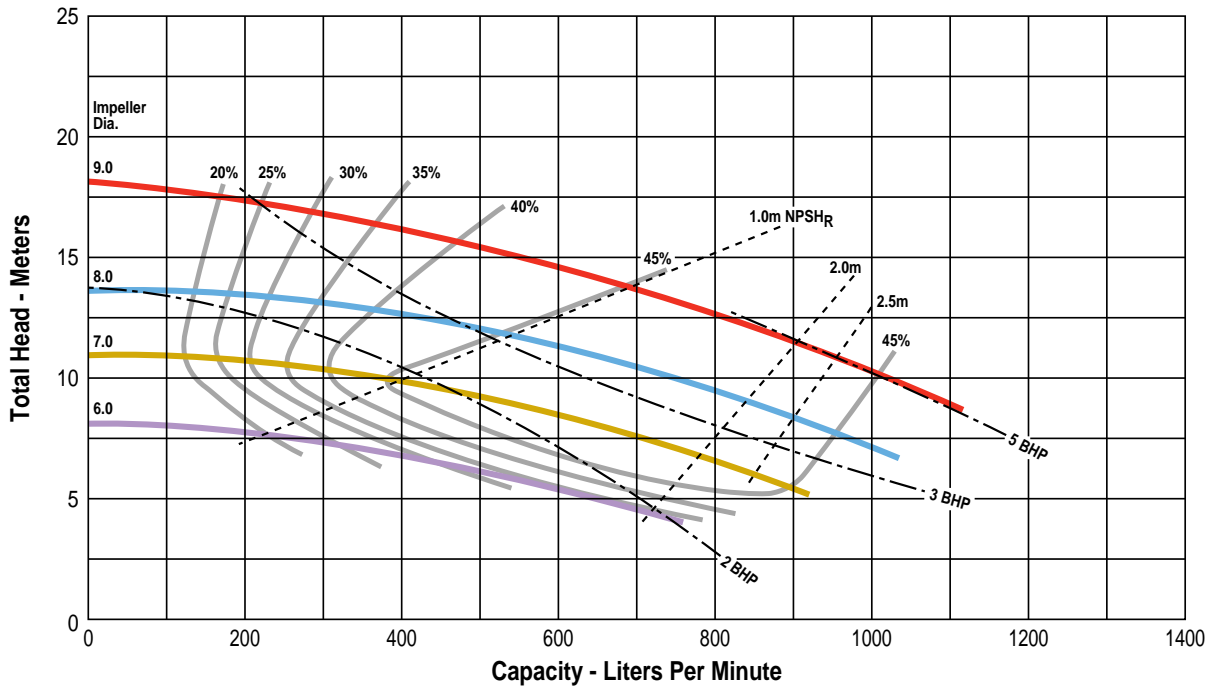

• 2900 RPM

• Curve #1095

KYNAR

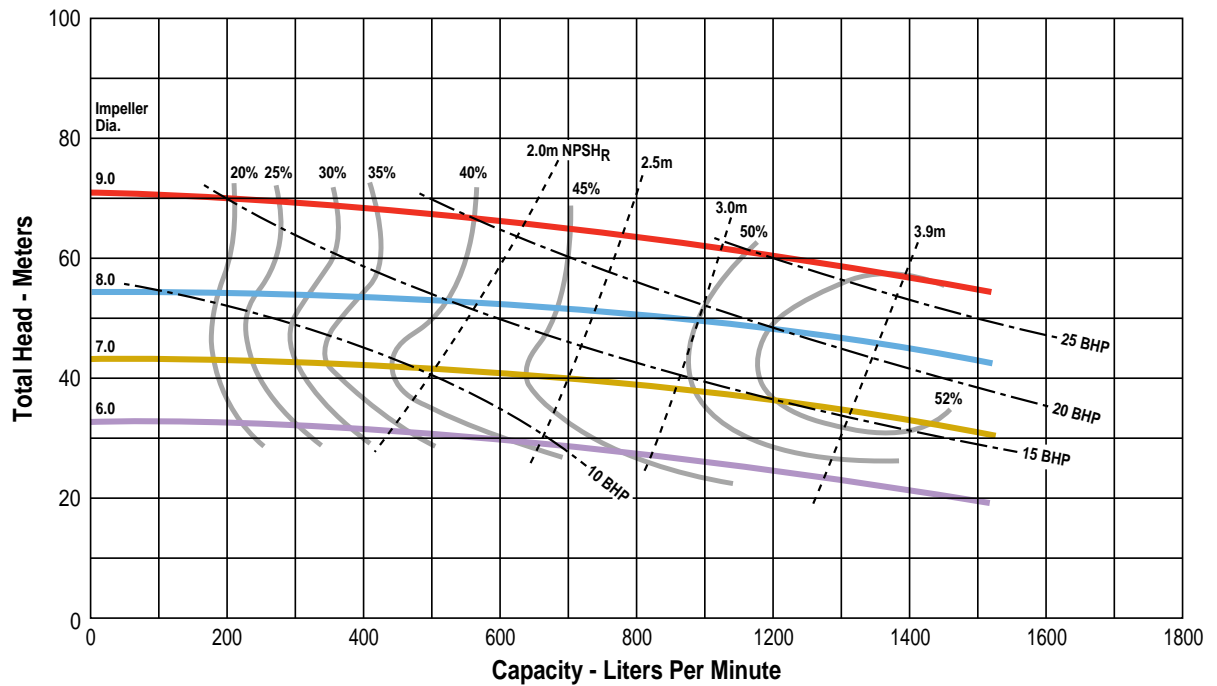

Group 2 Bearing Frame: 1-7/8" @ Seal

● **970 RPM**

● **Curve #1096**

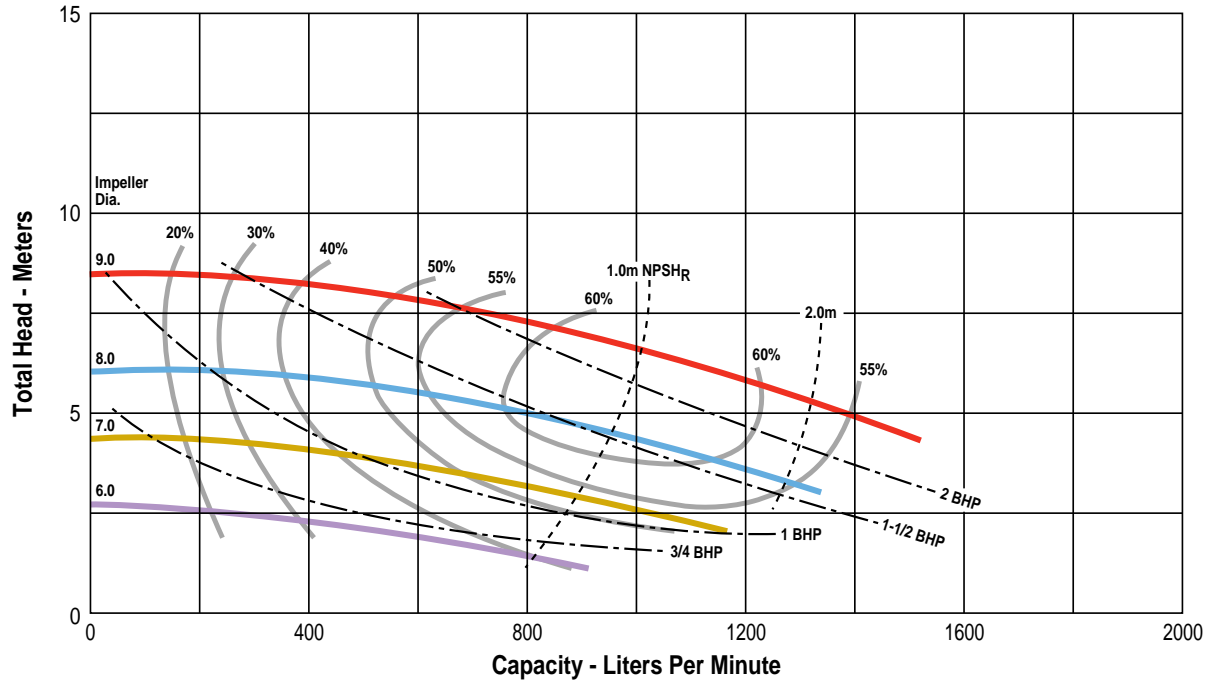

KYMAR

● **1450 RPM**

● **Curve #1097**

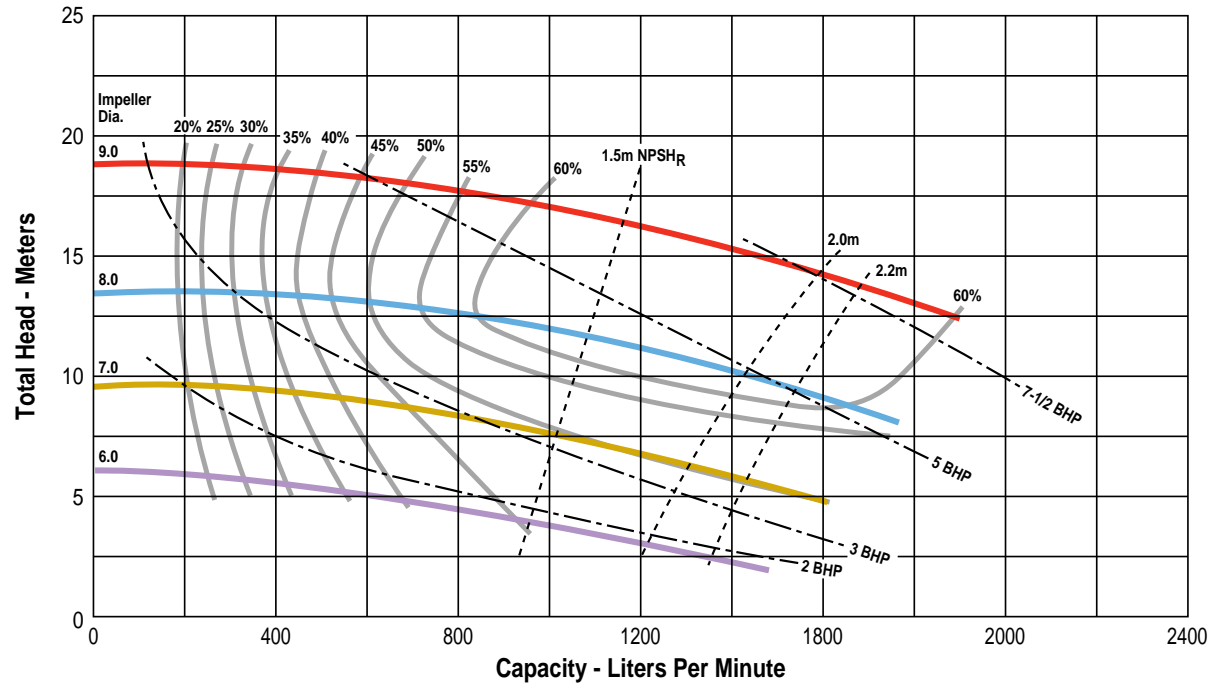

KYMAR

Group 3 Bearing Frame: 2-1/4" @ Seal

● 1450 RPM

● Curve #1098

KYNAR

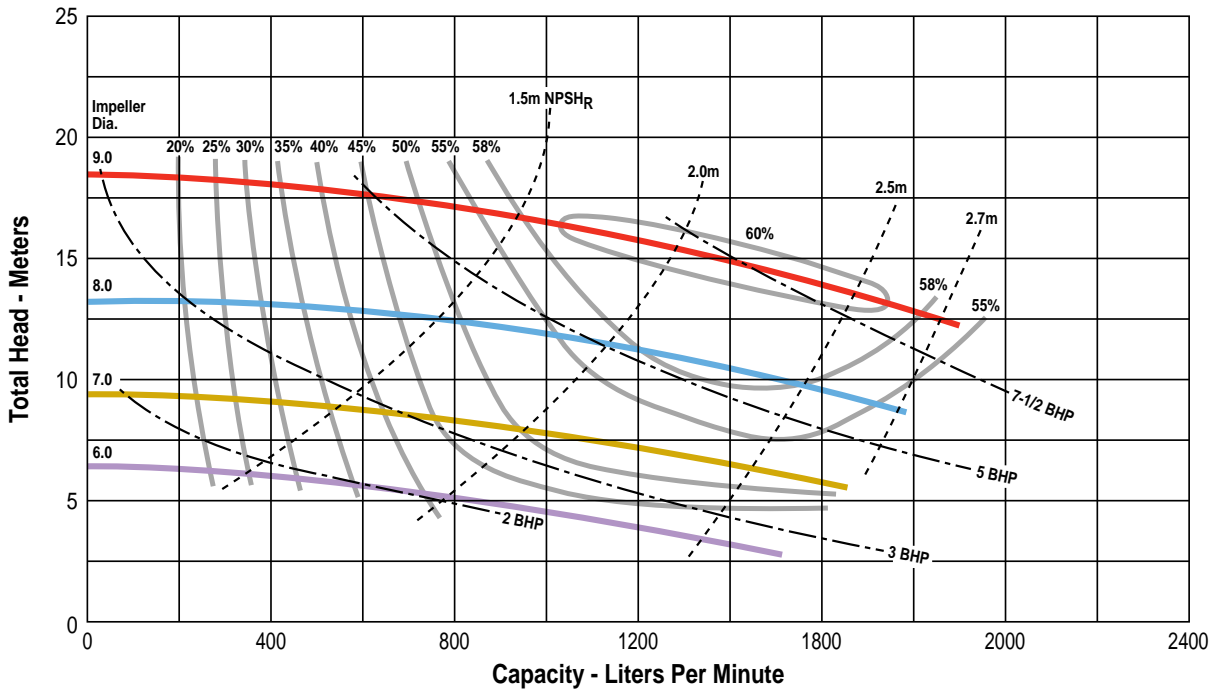

● 2900 RPM

● Curve #1099

KYNAR

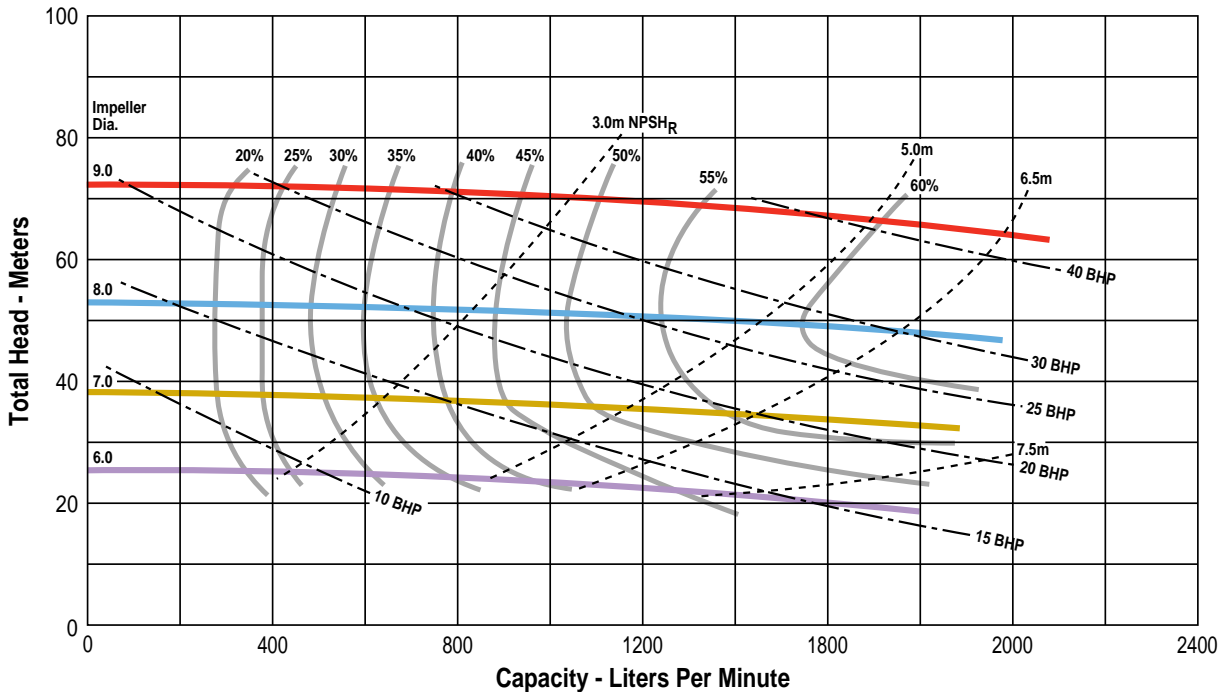

Group 2 Bearing Frame: 1-7/8" @ Seal

● **970 RPM**

● **Curve #1128**

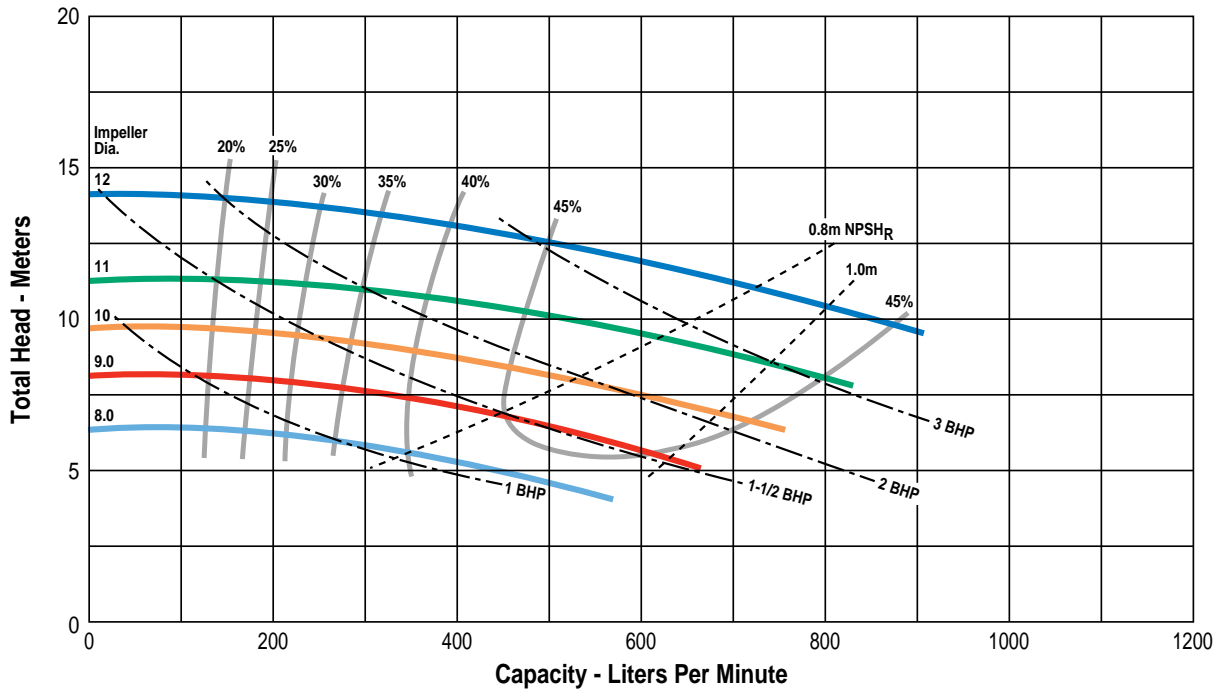

KYNNAR

● **1450 RPM**

● **Curve #1129**

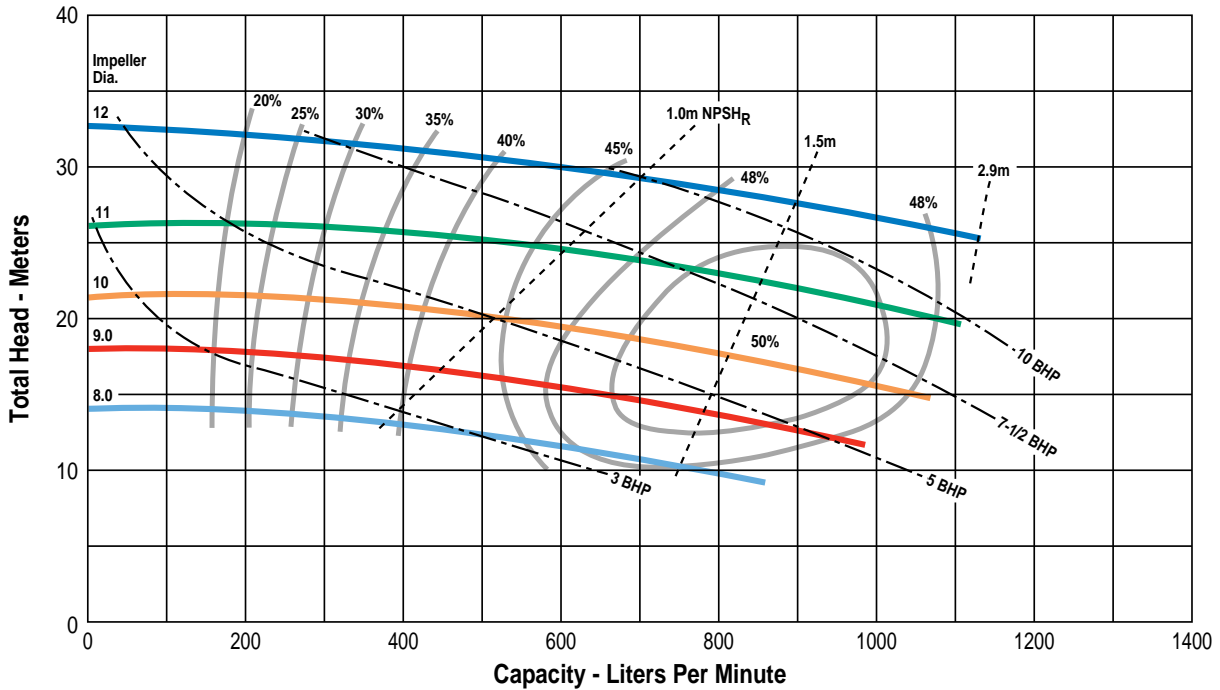

KYNNAR

Group 2 Bearing Frame: 1-7/8" @ Seal

• 970 RPM

• Curve #1130

KYNAR

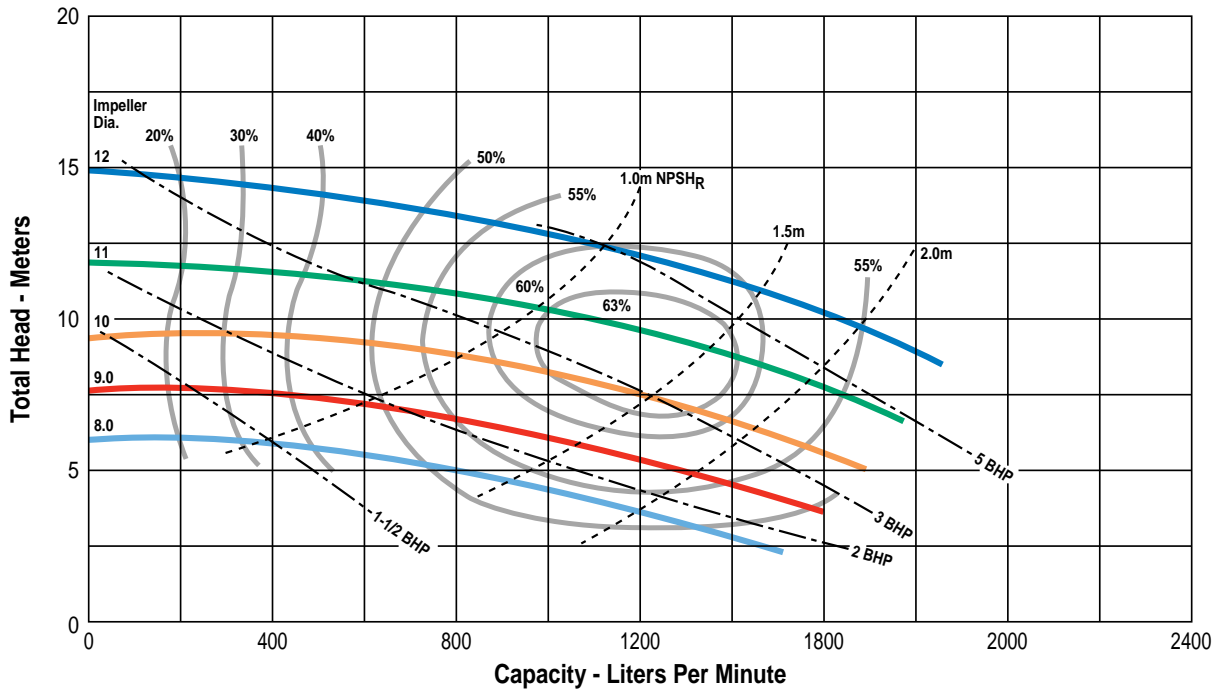

• 1450 RPM

• Curve #1131

KYNAR

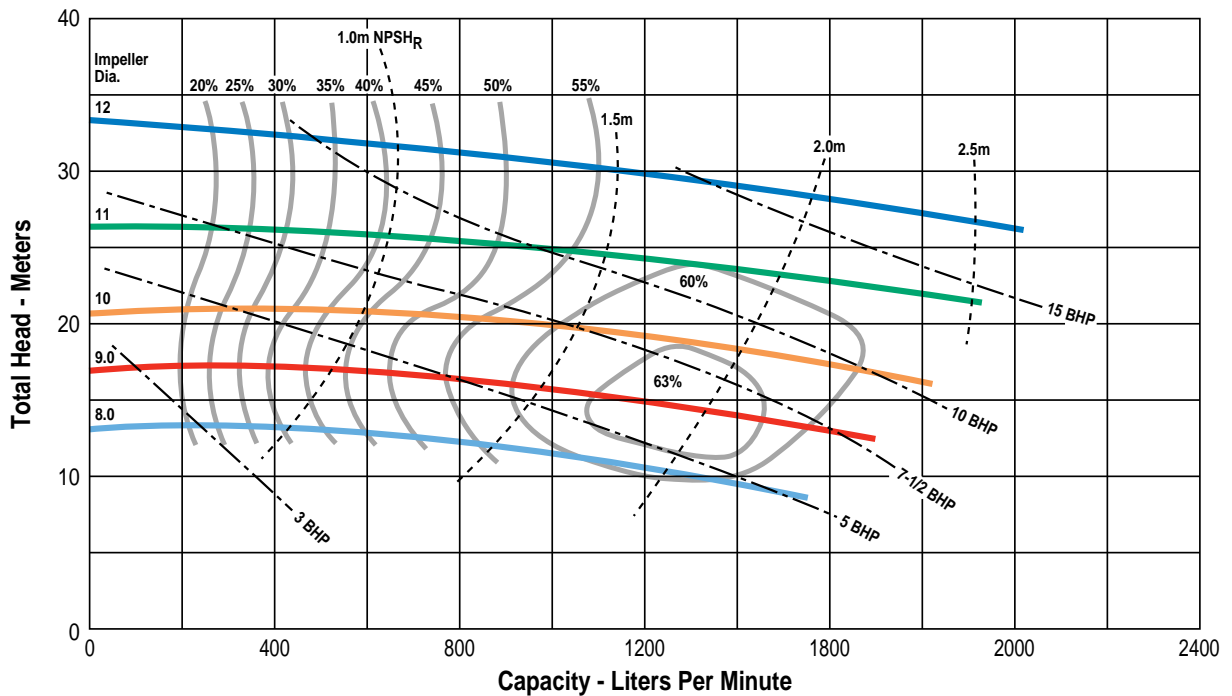

(inches)

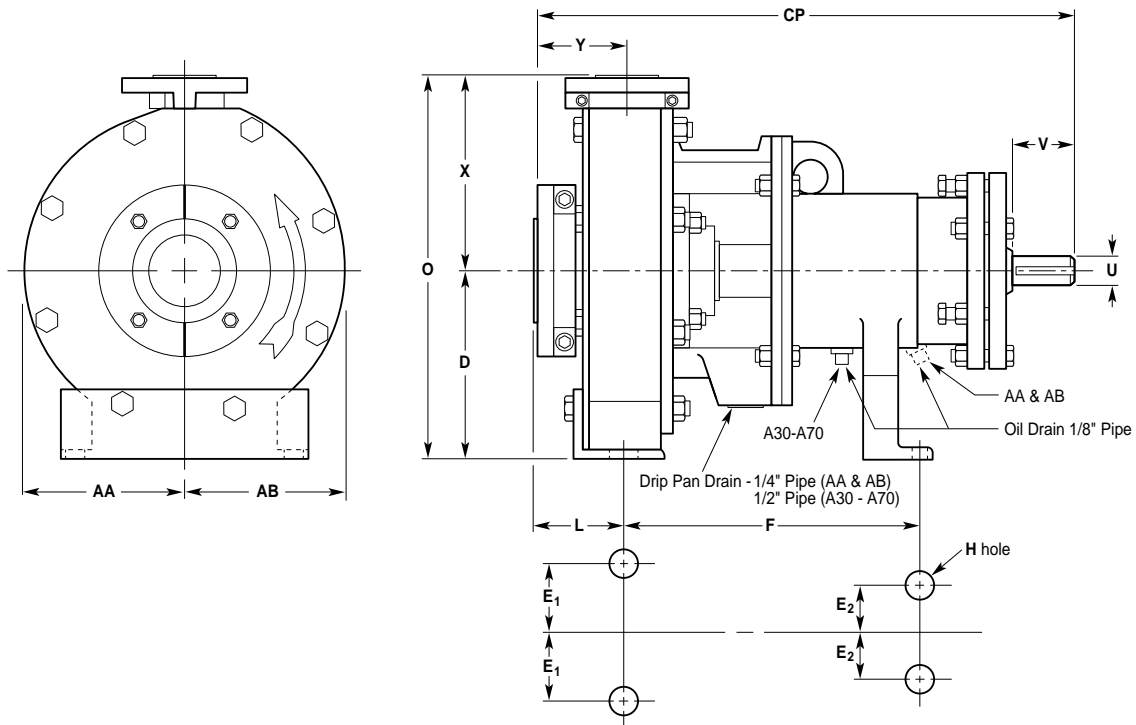

KYNAR

Carbon Filled Kynar 370 Pump Dimensions

Pump Designation	Pump Size	CP	D	2E ₁	2E ₂	F	H	L	Y	V (min)
PST-AA	1-1/2 x 1 x 6	17-1/2	5-1/4	6	0	7-1/4	5/8	4	4	2
PST-AB	3 x 1-1/2 x 6	17-1/2	5-1/4	6	0	7-1/4	5/8	4	4	2
PST-A30	3 x 2 x 12	23-1/2	10	9-3/4	7-1/4	12-1/2	5/8	4	4	2-5/8
PST-A40	4 x 3 x 12	23-1/2	10	9-3/4	7-1/4	12-1/2	5/8	4	4	2-5/8
PST-A50	3 x 1-1/2 x 9	23-1/2	8-1/4	9-3/4	7-1/4	12-1/2	5/8	4	4	2-5/8
PST-A60	3 x 2 x 9	23-1/2	8-1/4	9-3/4	7-1/4	12-1/2	5/8	4	4	2-5/8
PST-A70	4 x 3 x 9	23-1/2	8-1/4	9-3/4	7-1/4	12-1/2	5/8	4	4	2-5/8

Pump Designation	U		O	AA	AB	X	F + L	Impeller (max)	Diameter (min)
	Diameter	Keyway							
PST-AA	7/8	3/16 x 3/32	11-3/4	5-1/4	5-1/4	6-1/2	11-1/4	6	4
PST-AB	7/8	3/16 x 3/32	11-3/4	5-1/4	5-1/4	6-1/2	11-1/4	6	4
PST-A30	1-1/8	1/4 x 1/8	21-1/2	9-1/4	9-1/4	11-1/2	16-1/2	12	8
PST-A40	1-1/8	1/4 x 1/8	22-1/2	9-1/2	9-1/2	12-1/2	16-1/2	12	8
PST-A50	1-1/8	1/4 x 1/8	16-3/4	7-1/4	7-1/4	8-1/2	16-1/2	9	6
PST-A60	1-1/8	1/4 x 1/8	17-3/4	7-3/4	7-3/4	9-1/2	16-1/2	9	6
PST-A70	1-1/8	1/4 x 1/8	19-1/4	7-1/2	7-1/2	11	16-1/2	9	6

PST-AB-TFE Pump Designation

Pump Size: 3 x 1-1/2 x 6

Group 1 Bearing Frame: 1-1/2" @ Seal

● 1450 RPM

● Curve #1087

TEFLON

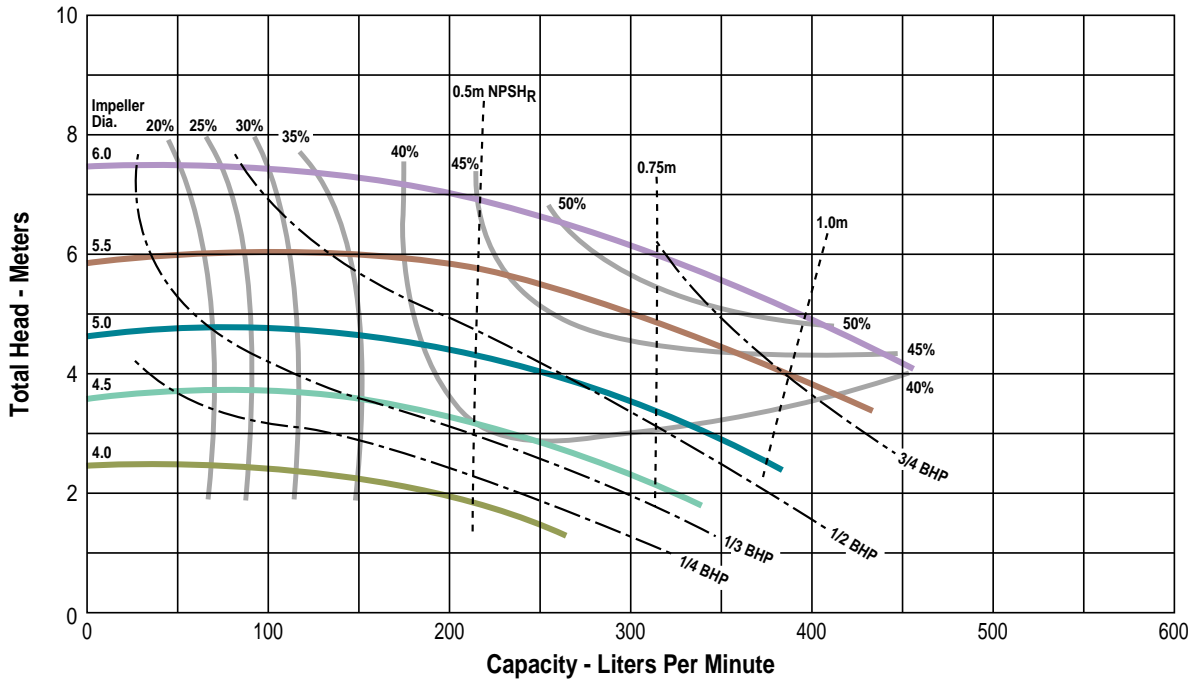

PST-A50M-TFE Pump Designation

Pump Size: 3 x 1-1/2 x 9

Group 2 Bearing Frame: 2" @ Seal

● 1450 RPM

● Curve #1089

TEFLON

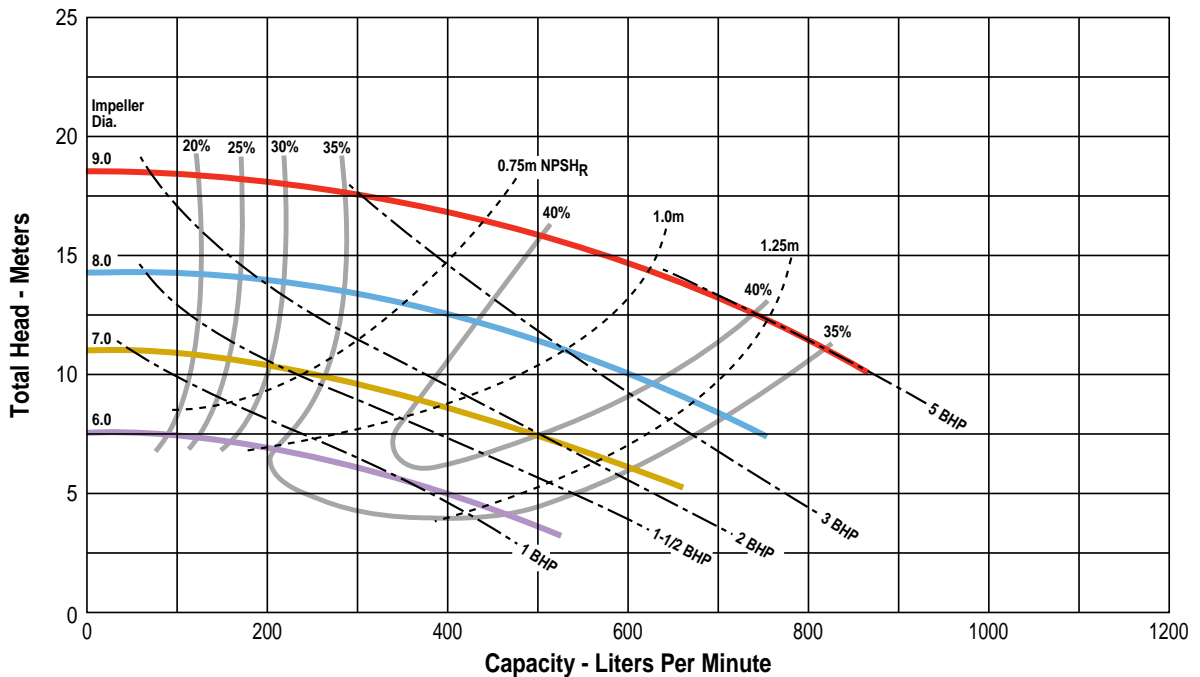

Dimensions

(inches)

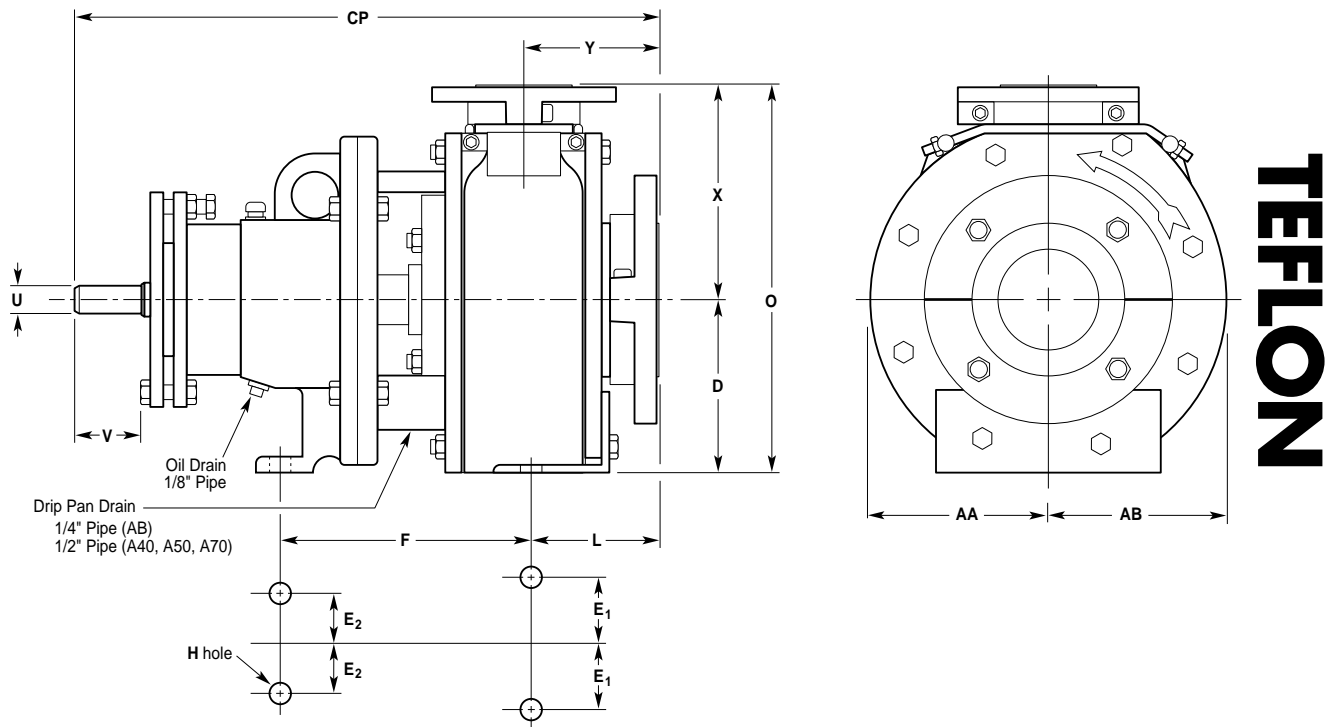

Glass Filled Teflon Pump Dimensions

Pump Designation	Pump Size	CP	D	2E ₁	2E ₂	F	H	L	Y	V (min)
PST-AB-TFE	3 x 1-1/2 x 6	17-1/2	5-1/4	6	0	7-1/4	5/8	4	4	2
PST-A50M-TFE	3 x 1-1/2 x 9	23-1/2	8-1/4	9-3/4	7-1/4	12-1/2	5/8	4	4	2-5/8
PST-A70M-TFE	4 x 3 x 9	23-1/2	8-1/4	9-3/4	7-1/4	12-1/2	5/8	4	4	2-5/8

Pump Designation	U		O	AA	AB	Impeller X	Diameter		(max)	(min)
	Diameter	Keyway					F + L			
PST-AB-TFE	7/8	3/16 x 3/32	11-3/4	5-1/4	5-1/4	6-1/2	11-1/4	6	4	
PST-A50M-TFE	1-1/8	1/4 x 1/8	16-3/4	7-1/4	7-1/4	8-1/2	16-1/2	9	6	
PST-A70M-TFE	1-1/8	1/4 x 1/8	19-1/4	8	7-1/2	11	16-1/2	9	6	

Stan-Cor Pump Design Specifications

Refer to the Stan-Cor Instruction Manual for complete installation, operation and maintenance instructions.

Location

Locate the pump near to the liquid source, so that the suction line is short and direct. When practical, locate the pump below the level of the liquid to eliminate the need for priming.

Foundation

The foundation should be sufficiently rigid and substantial to absorb any vibration, and to permanently support the base plate at all points. A concrete foundation, poured on a solid footing of adequate thickness to support the pumping unit, provides the most satisfactory foundation. The base plate should be installed in a level position. Baseplates should be grouted. For proper grouting procedures, refer to the Hydraulics Institute Standards.

Temperature Consideration

Check the pump model selected for temperature limitations using the graphs below. Please contact Wanner Engineering or your local Stan-Cor distributor for any assistance you may need with your specific application.

Notes:

- Maximum temperature for all Kynar 370 pumps: 250°F.
- Maximum temperature for Teflon pumps: 325°F
- For insulated pumps, multiply "maximum Discharge Pressure" by 0.8.

Coupling Alignment

Good service life of the pump and driver depends upon good alignment through the flexible coupling. If the electric motor is mounted at the factory, the pump and motor are in alignment when shipped. The alignment between the driver and pump should be inspected after installation to ensure that transportation or other handling has not caused misalignment. Poor alignment may cause failure of the coupling, pump, or motor bearings, or of either shaft. The recommended procedure for coupling alignment is to use a dial indicator detailed in the Stan-Cor Instruction Manual. For more information on coupling alignment, refer to the Hydraulic Institute Standards.

For TEFLON Pumps

AB, A50 and A70 Pump Designation

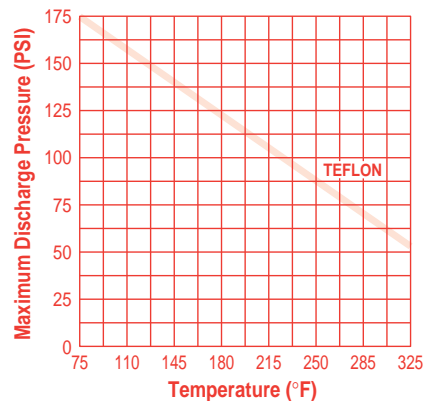

For KYNAR Pumps

AA and AB Pump Designation

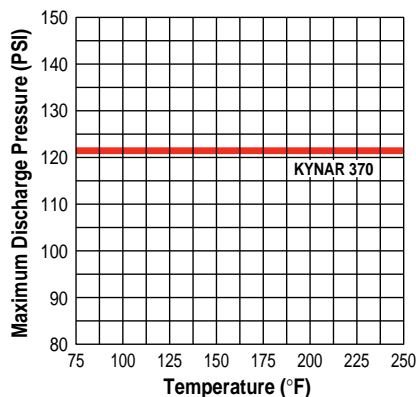

A50, A60 and A70 Pump Designation

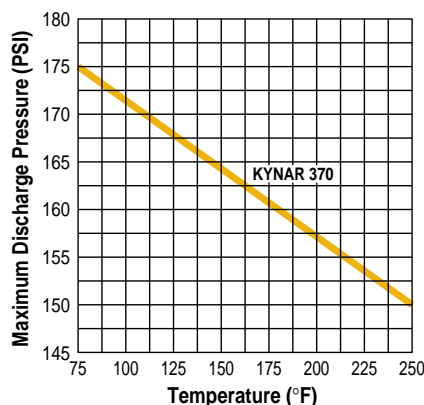

A30 and A40 Pump Designation

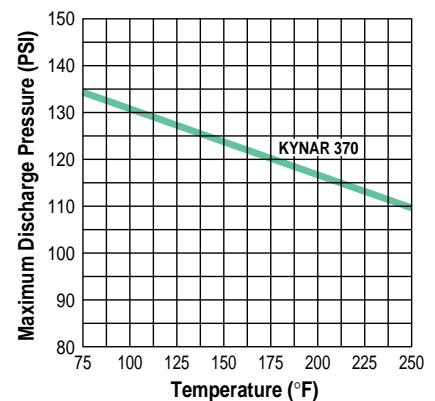

Stan-Cor Pump Design Considerations

Pump Weights

Kynar Pump Designation	Teflon Pump Designation	Weight (lbs)
PST-AA		115
PST-AB	PST-AB-TFE	120
PST-A50M	PST-A50M-TFE	200
PST-A50L		220
PST-A60M		210
PST-A50L		230
PST-A70M	PST-A70M-TFE	220
PST-A70L		240
PST-A30		270
PST-A40		280

Piping (General)

Anchor the piping independently of the pump and as near to it as possible. Pipe companion flanges should line up naturally with pump flanges. Do not draw the pipe to the pump with flange bolts. TFE envelope gaskets are recommended to effect a seal with minimum torque on flange bolts.

While the pump may be operated satisfactorily without expansion joints, we recommend that an FEP or TFE expansion joint be used on the suction and discharge flanges. Expansion joints eliminate undue strains caused by piping misalignment and/or temperature variations.

Arrange the piping so that corrosives can be flushed from the pump before it is opened for service. Installation of tees in the suction and discharge piping between the pump and the shutoff valves, with a drain valve connected to the branch of the tee, to permit flushing of the pump before removing it from the line.

Piping (Suction)

Properly selected and installed suction piping is extremely important to eliminate vibration and cavitation in the pump. Vibration can cause mechanical seal damage or undue bearing loads.

The suction line should be equal to or larger than the pump suction. The capacity of a centrifugal pump should never be adjusted by throttling the suction line. Install a positive shutoff valve of a type to cause minimum turbulence in the suction line — to permit the closing of the line and removal of the pump for inspection and maintenance.

The suction line should be designed to eliminate any air pockets. The piping should gradually slope downward to the source of supply to eliminate air pockets. The suction line should have a straight section into the pump of a length equivalent to at least two times its diameter: e.g., 4-in. dia. Suction line, 8-in. straight run.

Piping (Discharge)

Install a positive shutoff valve in the discharge piping to permit inspection and maintenance of the pump.

All piping should be independently supported and accurately aligned. The pump must not support the weight of the pipe or compensate for misalignment.

If operating conditions are not known with enough accuracy, provide a throttle valve in the discharge line to ensure that the pump operates at the design point.

When to use MTM (Metal-to-Metal) Impeller/ Shaft Sleeve Design Kynar Pumps

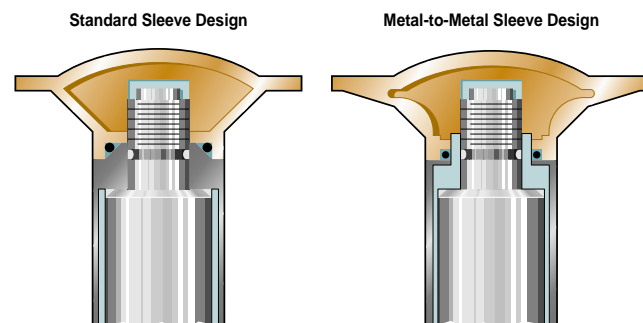

On the standard Stan-Cor Kynar pump design, the drive shaft is protected by a Kynar-encased sleeve that threads directly into the impeller hub. An O-ring seals between the Kynar of the impeller and the Kynar of the shaft sleeve to insure that corrosive process fluids do not come into contact with any metallic parts.

For added protection on demanding applications which utilize large-size impellers over 9" in diameter, the Stan-Cor PST-A60M, PST-A30 and PST-A40 can be fitted with an optional MTM impeller/sleeve design in which the metal insert of the shaft sleeve extends around the drive shaft. When the shaft is threaded into the impeller and tightened, this sleeve extension forms a solid metal-to-metal contact with the impeller hub for added impeller stability.

For strenuous pump applications in which the pump undergoes excessive cavitation or in which the pump is allowed to "run off the curve" because of low head and high flow requirements, the MTM option provides the added impeller stability to help avoid the possibility of excessive impeller deflection. As with the standard design sleeve design, the MTM sleeve is coated with Kynar and an O-ring seals between the sleeve and impeller so that no metallic parts come into contact with the process fluid.

If occasional upset conditions as described earlier occur in the application, the MTM design option should be considered to help protect the pump from damage during the occurrences. The MTM design will not stop the effects of cavitation, but it can protect the pump from damage for a period of time. System problems that lead to these occurrences must still be dealt with to insure proper and trouble-free operation of the Stan-Cor pump.

Terms & Conditions of Sale

1. Acceptance

The sales contract incorporating these terms and conditions becomes a binding contract on the terms set forth herein, when it is accepted by acknowledgment or commencement of performance. This contract can be accepted only on the exact terms set forth herein (including the modes of acceptance specified in the immediately preceding sentence) and no terms which are in any manner whatsoever additional to or different from those set forth herein shall become a part of or in any way alter this contract without the express written consent of Wanner Engineering, Inc., a Minnesota corporation ("WEI").

2. Terms of Payment

Unless otherwise stated on the invoice face WEI's domestic terms are 1% 10 net 30 days after the date of WEI's invoice. INTEREST WILL BE CHARGED AT THE RATE OF 1 1/2% PER MONTH OR THE MAXIMUM LEGAL RATE, WHICHEVER IS LESS, ON PAST DUE ACCOUNTS AFTER 30 DAYS FROM DATE OF INVOICE. Export terms require a confirmed irrevocable letter of credit to be opened by Purchaser at its expense including bank confirmation charges through a prime US bank unless otherwise specified. All letters of credit shall be in favor of and acceptable to WEI, shall be maintained in sufficient amounts and for the period necessary to meet all payment obligations, shall be irrevocable and shall be issued or confirmed by the bank to WEI within sixty (60) days after acceptance of the order by WEI, shall permit partial deliveries and shall provide for pro-rata payments upon presentation of WEI's invoices and certificate of delivery, or of delivery into storage with certification of cause therefor, and for the payment of any cancellation charges. Boxing, cartage, freight, insurance, handling, labor, rental and similar expenses are net cash upon receipt of invoice. All deliveries are at WEI's docks at its plant in Minneapolis, Minnesota, unless otherwise specified in WEI's sales order or quote. In the event that collection of invoices is placed in the hands of an attorney, Purchaser agrees to pay all reasonable costs and attorney's fees.

3. Prices

Prices in effect at time of delivery will apply unless otherwise stated in writing. Cost of export boxing and preparation is based on 3% of total net price. WEI's minimum charge for export boxing is \$15.00.

4. Limited Warranty, Remedy, Disclaimer

WEI warrants that for a period of one year from the date of delivery equipment manufactured by WEI shall be free of defects in materials and workmanship under normal use and service, and provided the equipment is installed, operated and maintained in accordance with instructions supplied by WEI. THIS LIMITED WARRANTY IS WEI'S SOLE AND EXCLUSIVE WARRANTY. If a defect in WEI's equipment appears within one year from the date of delivery, and Purchaser has given written notice of such defect within thirty (30) days from the discovery thereof, WEI will repair or replace the defective part, at its option. WEI requires the return to a designated WEI location, of the defective part, transportation prepaid, to establish Purchaser's claim. A return goods authorization must be received prior to the return of the defective part. No allowance will be made for repairs undertaken without WEI's written consent or approval. This limited warranty does not cover normal wear, or wear caused by or related to abrasion, corrosion, abuse, negligence, accident, faulty installation, or tampering which impairs normal operation of the equipment. This limited warranty applies only to equipment manufactured by WEI. Warranties, if any, on equipment manufactured by others including but not limited to electric motors (if applicable), are assigned to the Purchaser by WEI (without recourse) at time of delivery. Any descriptions of the equipment drawings, specifications, and any samples, models, bulletins, or similar material, used in connection with this sale are for the sole purpose of identifying the equipment and are not to be construed as an express warranty that the equipment will conform to such description. Any field advisory or installation support is advisory only. THE FOREGOING WARRANTIES ARE IN LIEU OF ALL OTHER WARRANTIES. WHETHER ORAL, WRITTEN, EXPRESS, IMPLIED OR STATUTORY, IMPLIED WARRANTIES OF MERCHANTABILITY AND FITNESS FOR A PARTICULAR PURPOSE WILL NOT APPLY. WEI'S WARRANTY OBLIGATIONS AND PURCHASER'S REMEDIES THEREUNDER ARE SOLELY AND EXCLUSIVELY AS STATED HEREIN. The Purchaser's sole and exclusive remedy, whether based upon warranty, contract or tort, including negligence, will be to proceed under this warranty. All liability of WEI shall terminate one year from the date of delivery of the equipment.

5. Limitation of Liability

WEI shall in no event be liable for special, indirect, incidental or consequential damages, including environmental damage claims. WEI's total liability on any claim of any kind arising out of this sales contract shall in no case exceed the price paid by Purchaser for the equipment or the part thereof giving rise to the claim. WEI disclaims all liability, whether in contract, tort, warranty, or otherwise, to any party other than Purchaser.

Wanner Engineering, Inc.

1204 Chestnut Avenue, Minneapolis, MN 55403 USA

(612) 332-5681 FAX (612) 332-6937

Toll Free FAX (USA only) (800) 332-6812

Email: sales@wannereng.com

Website: www.wannereng.com

Document Fax Back System: (510) 745-0440

6. Shipping Dates

The time given for shipment is approximate and is estimated from the date of receipt of the order together with complete manufacturing information and approval of drawings as may be necessary. Partial deliveries shall be permitted.

WEI shall not be liable for any losses or damages for delay or non-delivery due to the acts of civil or military authority, fuel shortages, acts of the Purchaser or by reason for "force majeure" which shall be deemed to mean all causes whatsoever not reasonably within the control of WEI including, but not limited to acts of God, war, riot, insurrection, boycott or other civil disturbances, blockages, embargoes, sabotage, epidemics, fires, strikes, lockouts, or other industrial disturbances, delays of carriers, and inability to secure materials, labor or manufacturing facilities. The foregoing extension of delivery will apply even though such cause(s) may occur after WEI's delivery has been delayed for other causes. If any part of the equipment cannot be delivered when ready due to any cause referred to above, WEI may place such equipment in storage. In such event (1) WEI's delivery obligations shall be deemed fulfilled and title and all risk of loss or damage shall thereupon pass to Purchaser, (2) any amounts otherwise payable to WEI upon delivery shall be payable upon presentation of WEI's invoices and its certification as to such cause, and (3) all expenses incurred by WEI such as for preparation for and placement into storage, handling, inspection, preservation and insurance, shall be payable by Purchaser upon submission of WEI's invoices.

The delivery dates are based on standard quality control checks as a part of the normal production sequence. Additional inspection or testing required by Purchaser which affects normal production sequence, will be considered as extending the shipping dates accordingly.

7. Payments

The prices specified are in US currency, payable in Minneapolis, Minnesota exchange free of all expenses to WEI for collection charges. Pro rata payments shall be made for partial shipments. If delivery is prevented or postponed at the Purchaser's request, or by reason of any other cause set forth specifically or by implication in paragraph 6 above, then all dates of payment related to delivery shall relate instead to the placement of such equipment in storage. Letters of credit or other credit instruments established to provide payment for the equipment shall make provision for payment as set forth above where delivery is prevented or postponed under such circumstances. Storage of such equipment shall be at Purchaser's expense and risk. When in the opinion of WEI the financial condition of the Purchaser renders it necessary, WEI may require cash payment or satisfactory security before shipment.

8. Changes and Drawings

WEI reserves the right to change or modify the design and construction of equipment and to substitute other suitable material. WEI is not required to retrofit units in the field because of an engineering change.

If Purchaser for any reason makes changes within the general scope of this contract which affect the (1) drawings, designs or specifications of equipment being specifically manufactured for Purchaser; (2) method of shipment or packing; (3) place of delivery; and, (4) delivery schedules, and any such change causes an increase or decrease in the cost of, or the time required for, performance of this contract, an equitable adjustment shall be made in the contract price or delivery schedule or both. Changes in this contract shall, however, only be considered if they are directed in writing to WEI by Purchaser's Purchasing Department and accepted in writing by WEI. On receipt of such written directions WEI shall within 30 days notify Purchaser of its claim for adjustment.

9. Cancellation

The Purchaser may cancel his order only upon written notice and payment to WEI of WEI's cancellation charges. Equipment or parts of special design, size or materials are normally not returnable. Written permission must be secured before returning standard equipment or parts, and these returns will be subject to a restocking charge as determined by WEI. No rubber products may be returned for credit after six (6) months from date of delivery.

10. Suspension

If WEI's performance of the work is delayed for a period of more than six (6) months at the request of Purchaser or by reason of the acts of civil or military authority, or "force majeure", upon removal of the cause for any such delay, performance shall be resumed, delivery will be rescheduled, and the purchase price shall be adjusted to that in effect at the time of resumption of performance subject to such price adjusted clause as may then be applicable. If Purchaser is unwilling to accept the adjusted price and projected delivery date, Purchaser may cancel its order by giving written notice thereof to WEI at any time within thirty (30) days after Purchaser has been advised of WEI's adjusted price and projected delivery date and upon payment of reasonable cancellation charges specified by WEI.

Wanner International Ltd.

Grange Court, Grange Road

Tongham, Surrey GU10 1DW, England

Tel +44 (0) 1252 781234

FAX Tel +44 (0) 1252 781235

Email: sales@wannerint.com