



Adaptable Laboratory Furniture

Trust ● Create ● Discover

ICI Scientific Introduction



History - Since 1951

Institutional Casework Inc. (ICI Scientific) is uniquely positioned to serve your complete project needs from steel, stainless steel, or custom wood laboratory and science casework to equipment, fixtures, work surfaces and fumes hoods.

ICI is privately owned, ensuring a primary focus on quality. This focus enables us to build a strong connection with our customers, employees, distributors and suppliers.

Introducing ICI Scientific - specifically designed and positioned to meet the requirements of Tier One laboratory specifications. ICI Scientific brings your preliminary concept to life; assisting from design through installation in partnership with our world-wide distributor network; delivering post-sale service and support through the lifetime of our products.

ICI Scientific is your single source for a complete laboratory. With brands steeped in a rich history, ICI Scientific is uniquely positioned to provide the complete laboratory project. Being privately owned, we ensure our primary focus is on quality, without the distraction of fluctuating stocks. We are focused on building a strong connection with employees, dealers, distributors, customers and end users.

All levels of laboratories and learning environments are created at ICI through flexibility, function, innovation and design.

American Made

ICI's multiple manufacturing facilities comprise 450,000 sq. ft. with 250 associates; ICI Scientific is a global provider of American Made products.

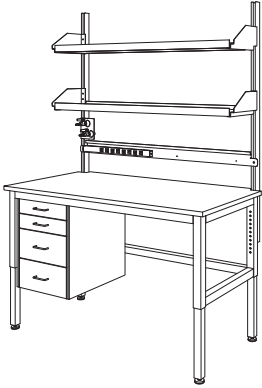
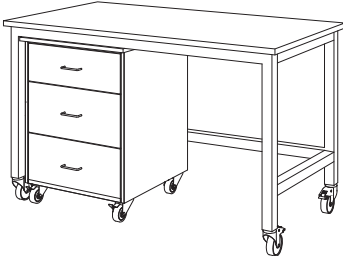
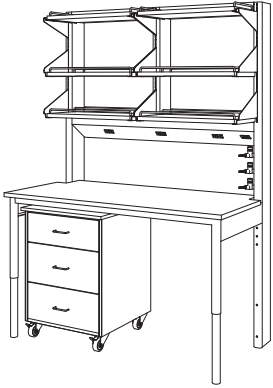

Table of Contents



Category	Page Numbers
Adaptable Furniture Selection Chart	4-5
Patriot Table	6-12
Heavy Duty Table	13-15
Envision 3.0	16-40
Envision 3.5	41-60
Envision 4.0	61-85
Envision 4.5	86-105
Envision Plumbing	106-108
Envision Accessories	109-112
Envisions Upright Configurator	113-117
FlexCore Mobile Cart	118-120
FlexCore Wall Rails	121-125
FlexCore Frame	126-134
FlexCore Connectors	135-142
FlexCore Fillers	143-145
FlexCore Cantilever Frame	146
FlexCore Work Surfaces	147
FlexCore Shelving	148-151
FlexCore Accessories	152-153
FlexCore Process Table	154-155
FlexCore Services	156-157
Steel Suspended Cabinets	158-166
Steel Mobile Cabinets	167-173

Adaptable Furniture Selection Chart

	Patriot Table	Heavy Duty Table	Envision 3.0
			
Features:			
Adjustable Height	Yes	No	Yes
Leveling Glides	Nylon Leveling Glides (Standard)	Nylon Leveling Glides (Standard)	Nylon Leveling Glides (Standard)
Casters	Locking Swivel Casters or Vibration Isolation Casters (Option)	Locking Swivel Casters or Vibration Isolation Casters (Optional)	Leveling Casters (Option, only for 3" uprights)
Electrical Location	Plug Bar (Option)	N/A	Cross Member (Option)
Data Location	N/A	N/A	Cross Member (Option)
Upright Type	1 5/8" thick uprights attached to table frame	N/A	3" or 6" uprights
Leg Type	Square Tube	Square Tube	Round Tube
Turret Options	Ball Valve	N/A	Ball Valve or Instrument Valve
Configuration	Single Sided (with uprights)	N/A	3" Upright, Single Sided or 6" Upright, Double Sided
Work Surface Weight Capacity	1,000 lbs	1,000 lbs	1,200 lbs
Suspended Cabinet Compatible	Yes	Yes	Yes - Work Surface must be greater than 24" deep
SEFA	SEFA 10 - Class 7, Category 4 (Compliant)	SEFA 10 - Class 7, Category 4 (Compliant)	SEFA 10 - Class 7, Category 4 (Certified)
UL Listed	N/A	N/A	UL 962
Task Lighting	Yes (Option)	N/A (Option)	Yes (Option)
Work Surface Height Range	29" - 37" (1" increments)	N/A	30 1/4" - 36 1/4" (2" increments)

Note: All images are shown with multiple options.

Adaptable Furniture Selection Chart

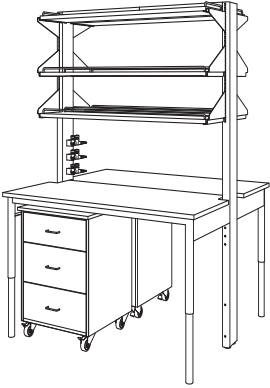
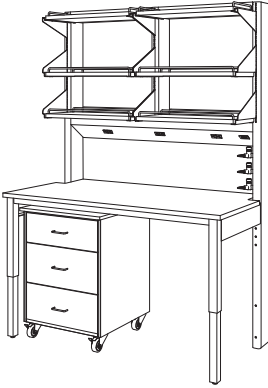
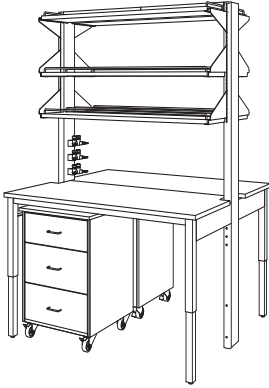
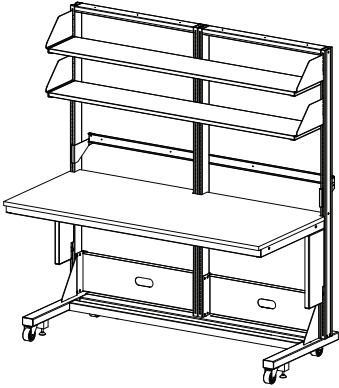
Envision 3.5	Envision 4.0	Envision 4.5	FlexCore Mobile Cart
			
Yes	Yes	Yes	Yes
Nylon Leveling Glides (Standard)	Nylon Leveling Glides (Standard)	Nylon Leveling Glides (Standard)	Standard Casters (Option) Standard Casters with Levelers (Option)
N/A	Leveling Casters (Option, only for 3" uprights)	N/A	Leveling Casters (Option)
Upright (Option)	Cross Member (Option)	Upright (Option)	Plug Bar (Option)
Upright (Option)	Cross Member (Option)	Upright (Option)	N/A
6" Uprights	3" or 6" Uprights	6" Uprights	3 1/4" Upright
Round Tube	Square Tube	Square Tube	N/A
Ball Valve or Instrument Valve	Ball Valve or Instrument Valve	Ball Valve or Instrument Valve	N/A
6" Upright, Double Sided	3" Upright, Single Sided or 6" Upright, Double Sided	6" Upright, Double Sided	3 1/4" Flex Upright
1,200 lbs	1,200 lbs	1,200 lbs	Weight Capacity of Cantilever Frame up to 600 lbs UDL (includes weight of work surface or suspended cabinets)
Yes - Work Surface must be greater than 24" deep	Yes - Work Surface must be greater than 24" deep	Yes - Work Surface must be greater than 24" deep	Yes
SEFA 10 - Class 7, Category 4 (Certified)	SEFA 10 - Class 7, Category 4 (Certified)	SEFA 10 - Class 7, Category 4 (Certified)	SEFA 10 - Class 7, Category 4 (Compliant)
UL 962	UL 962	UL 962	N/A
Yes (Option)	Yes (Option)	Yes (Option)	Yes (Option)
30 1/4" -36 1/4" (2" increments)	30 1/4" -36 1/4" (2" increments)	30 1/4" -36 1/4" (2" increments)	29"-37" (1" increments)

Note: All images are shown with multiple options.

Patriot Table

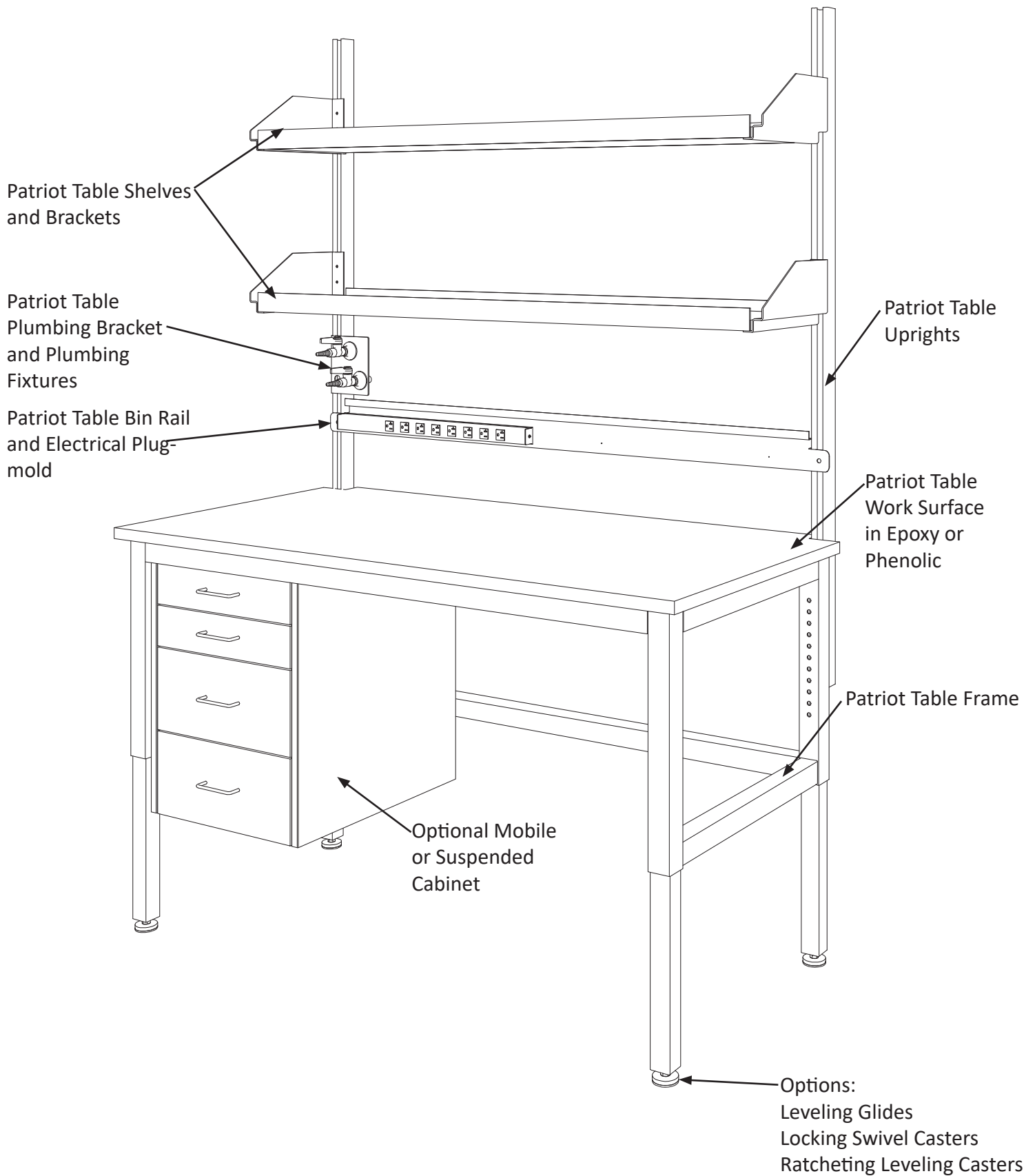

Adjustable Height Patriot Table Frame with Leveling Glides

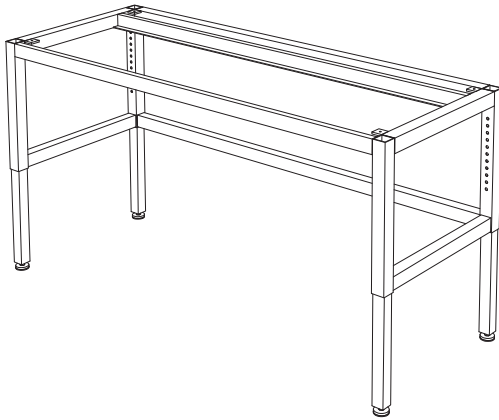
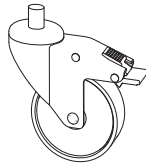

Table Frame with Leveling Glides

- Standard with Leveling Glides
- Leveling glides have 1/2" stem and 1 3/4" foot
- Patriot tables have a mechanical bolt style height adjustment
- Add "S" at the beginning of the part number for stainless steel
- Leveling glides ship installed
- Work Surface purchased separately
- Weight capacity up to 1,000 lbs

Cat. No.	Dimensions (W x D x H)
24" Deep	
JPAT-4824NT-A	48" x 24" x 29"-36"
JPAT-6024NT-A	60" x 24" x 29"-36"
JPAT-7224NT-A	72" x 24" x 29"-36"
JPAT-8424NT-A	84" x 24" x 29"-36"
JPAT-9624NT-A	96" x 24" x 29"-36"
30" Deep	
JPAT-4830NT-A	48" x 30" x 29"-36"
JPAT-6030NT-A	60" x 30" x 29"-36"
JPAT-7230NT-A	72" x 30" x 29"-36"
JPAT-8430NT-A	84" x 30" x 29"-36"
JPAT-9630NT-A	96" x 30" x 29"-36"
36" Deep	
JPAT-4836NT-A	48" x 36" x 29"-36"
JPAT-6036NT-A	60" x 36" x 29"-36"
JPAT-7236NT-A	72" x 36" x 29"-36"
JPAT-8436NT-A	84" x 36" x 29"-36"
JPAT-9636NT-A	96" x 36" x 29"-36"

Add Locking Swivel Casters to Patriot Table



- (4) 4" Locking Swivel Casters
- Weight capacity up to 1,000 lbs

Cat. No.	Type
PAT-C	(4) Locking Swivel Casters

Add Ratcheting Leveling Casters to Patriot Table

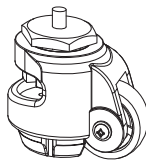

- (4) Ratcheting Leveling Caster has a ratchet style leveling function
- Weight capacity up to 1,000 lbs

Cat. No.	Type
PAT-HD	(4) Ratcheting Leveling Casters

Patriot Table

Patriot Table Standard Uprights

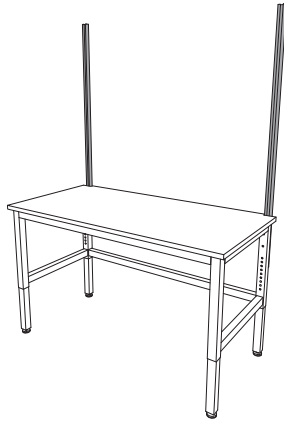

- Pair of uprights, 47" above work surface
- Can be attached to any size Patriot table
- Attachment hardware included
- Add "S" at beginning of part number for stainless steel

Cat. No.	Type
PAT-UPR	Standard Uprights for Patriot Table

Patriot Table "Stubby" Uprights

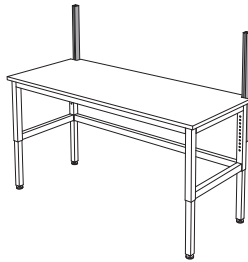

- Pair of uprights, 12" above work surface
- Can be attached to any size Patriot table
- Attachment hardware included
- Add "S" at beginning of part number for stainless steel

Cat. No.	Type
PAT-SUPR	"Stubby" Uprights for Patriot Table

Shelf and Brackets

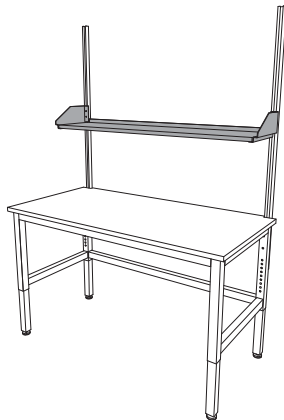

- Includes a 12" deep painted steel shelf with bookend brackets
- Attachment hardware included
- To be used with Patriot Table Uprights
- Add "S" at beginning of part number for stainless steel

Cat. No.	For use with:
PAT-4S	48" wide Table
PAT-5S	60" wide Table
PAT-6S	72" wide Table
PAT-7S	84" with Table
PAT-8S	96" wide Table

Shelf Lips

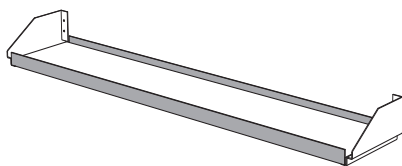

- Includes a pair of painted steel shelf lips
- Add "S" at beginning of part number for stainless steel
- Attachment hardware included

Cat. No.	For use with:
PAT-JPPSL48	48" wide Patriot Table
PAT-JPPSL60	60" wide Patriot Table
PAT-JPPSL72	72" wide Patriot Table
PAT-JPPSL84	84" with Patriot Table
PAT-JPPSL96	96" wide Patriot Table

Phenolic Work Surface for Patriot Table

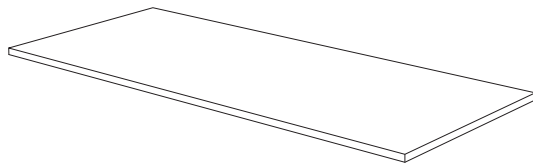

No Notch Shown

- 1" thick black phenolic resin work surface
- Can be notched for uprights
- See page 7 for table frame

Cat. No.		Dimensions	
No Notch	With Notch	Depth	Width
24" Deep			
JPAT-4824PRT	JPAT-4824PRTN	24"	48"
JPAT-6024PRT	JPAT-6024PRTN	24"	60"
JPAT-7224PRT	JPAT-7224PRTN	24"	72"
JPAT-8424PRT	JPAT-8424PRTN	24"	84"
JPAT-9624PRT	JPAT-9624PRTN	24"	96"
30" Deep			
JPAT-4830PRT	JPAT-4830PRTN	30"	48"
JPAT-6030PRT	JPAT-6030PRTN	30"	60"
JPAT-7230PRT	JPAT-7230PRTN	30"	72"
JPAT-8430PRT	JPAT-8430PRTN	30"	84"
JPAT-9630PRT	JPAT-9630PRTN	30"	96"
36" Deep			
JPAT-4836PRT	JPAT-4836PRTN	36"	48"
JPAT-6036PRT	JPAT-6036PRTN	36"	60"
JPAT-7236PRT	JPAT-7236PRTN	36"	72"
JPAT-8436PRT	JPAT-8436PRTN	36"	84"
JPAT-9636PRT	JPAT-9636PRTN	36"	96"

Epoxy Work Surface for Patriot Table

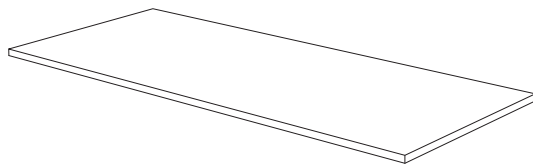

No Notch Shown

- 1" thick black epoxy work surface
- Can be notched for uprights
- See page 7 for table frame

Cat. No.		Dimensions	
No Notch	With Notch	Depth	Width
24" Deep			
JPAT-4824ERT	JPAT-4824ERTN	24"	48"
JPAT-6024ERT	JPAT-6024ERTN	24"	60"
JPAT-7224ERT	JPAT-7224ERTN	24"	72"
JPAT-8424ERT	JPAT-8424ERTN	24"	84"
JPAT-9624ERT	JPAT-9624ERTN	24"	96"
30" Deep			
JPAT-4830ERT	JPAT-4830ERTN	30"	48"
JPAT-6030ERT	JPAT-6030ERTN	30"	60"
JPAT-7230ERT	JPAT-7230ERTN	30"	72"
JPAT-8430ERT	JPAT-8430ERTN	30"	84"
JPAT-9630ERT	JPAT-9630ERTN	30"	96"
36" Deep			
JPAT-4836ERT	JPAT-4836ERTN	36"	48"
JPAT-6036ERT	JPAT-6036ERTN	36"	60"
JPAT-7236ERT	JPAT-7236ERTN	36"	72"
JPAT-8436ERT	JPAT-8436ERTN	36"	84"
JPAT-9636ERT	JPAT-9636ERTN	36"	96"

Pre-Mount for a Work Surface

- Use this part number to mount a work surface

Cat. No.	Type
PAT-PMP	Pre-mount for Phenolic Work Surface
PAT-PME	Pre-mount for Epoxy Work Surface

Patriot Table

LED Task Lighting for Patriot Tables

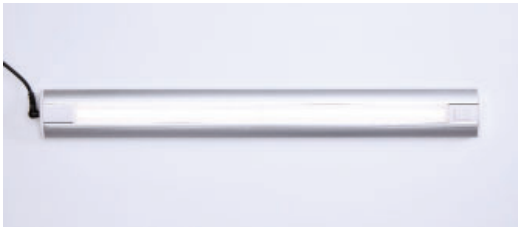

- Touch and hold continuous dimming and 10 hour automatic turnoff
- Includes LED task light, magnetic angle mount that allows for up to 25° of adjustment
- 60 watt power supply with magnetic mount and 6' white cord
- Made with anodized aluminum
- Lasts up to 50,000 hours

Cat. No.	Quantity of Lights	Actual Width	For use with:
TL17-LED	1	17"	48" wide Table
TL34-LED	2	17"	60" wide Table
TL34-LED	2	17"	72" wide Table
TL34-LED	2	17"	84" with Table
TL34-LED	2	17"	96" wide Table

Electrical Outlet Strip for Patriot Table

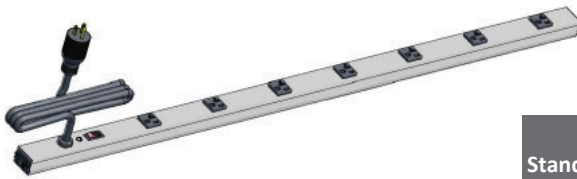

- Electrical Outlet Strip includes a mounting bar to attach to uprights
- Attachment hardware included
- 6' cord

Cat. No.		For use with:	Actual Outlet Strip Length	Number of Outlets
Standard 20 amp Plug	Twist-to-Lock 20 amp Plug			
PAT-EM4	PAT-EM4TL	48" wide Table	42"	7
PAT-EM5	PAT-EM5TL	60" wide Table	48"	8
PAT-EM6	PAT-EM6TL	72" wide Table	60"	10
PAT-EM7	PAT-EM7TL	84" with Table	70"	10
PAT-EM8	PAT-EM8TL	96" wide Table	70"	10

Plumbing Bracket for Patriot Table

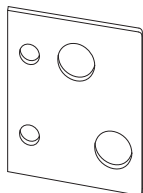

- Add "S" to the beginning of the part number for stainless steel
- Attachment hardware included
- Up to two turrets per bracket

Cat. No.

PAT-PB

Male Quick Connect for Patriot Table



Cat. No.	Service	Color
E3PFWQPM-K2	Air	Orange
E3PFWQPM-K4	Vacuum	Yellow
E3PFWQPM-K8	Nitrogen	Brown
E3PFWQPM-K6	Gas	Blue

Ball Valve Service Turret for Patriot Table

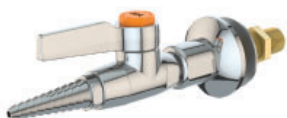

Cat. No.	Service	Color
PAT-L4200-A	Air	Orange
PAT-L4200-V	Vacuum	Yellow
PAT-L4200-N	Nitrogen	Brown
PAT-L4200-G	Gas	Blue

Reinforced PVC Service Hose for Patriot Table



Cat. No.	Length from Fixture	For use with:	Color
E3PRP5W4	84"	Non-burning gas	White
E3PRP5W6	108"		

Stainless Steel Service Hose for Patriot Table



Cat. No.	Length from Fixture	For use with:	Color
E3PSGW4	84"	Natural and Reactive Gases	Stainless Steel
E3PSGW6	108"		

Patriot Table

Keyboard Tray

Cat. No.	Type
KBTMP	Keyboard Tray with Mouse Pad

Monitor Arm

Cat. No.	Type
PAT-MA	Monitor Arm

CPU Holder

Cat. No.	Type
PAT-CPUH	CPU Holder

Heavy Duty Table

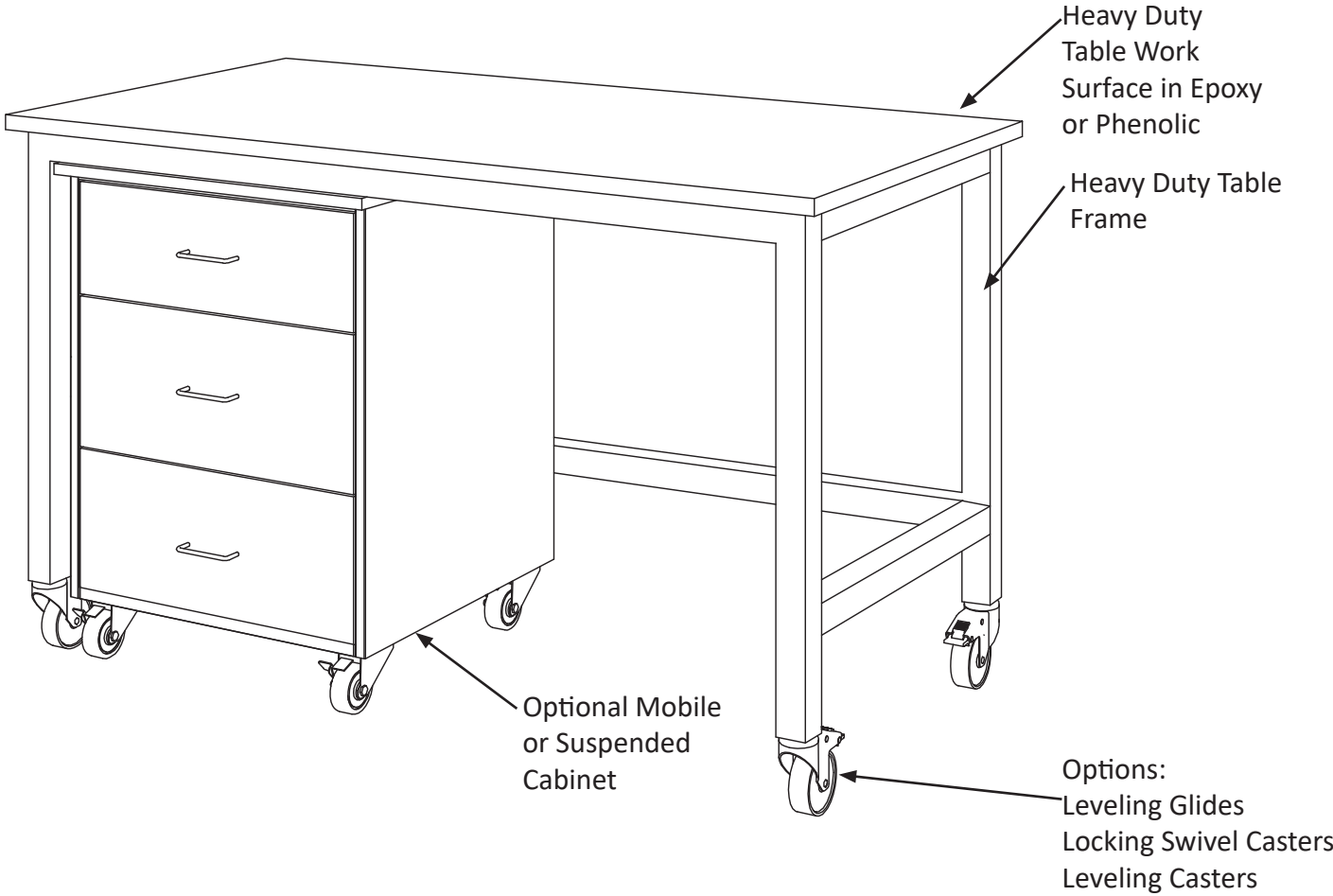

Heavy Duty Table

Fixed Height Heavy Duty Table Frame with Leveling Glides

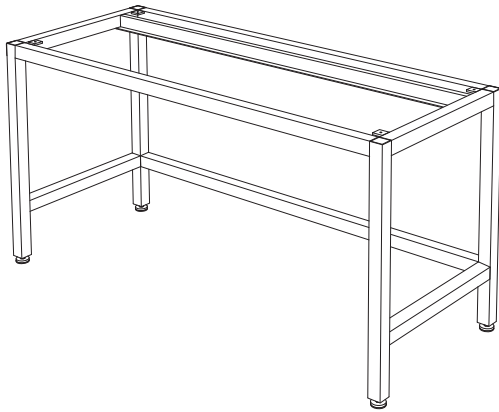

JHDPAT-6030NT

- Leveling glides have 1/2" stem and 1 3/4" foot
- Add "S" at the beginning of the part number for stainless steel
- Some assembly required
- Work surface ordered separately
- Work surface can be attached, see page ___
- Not available with adjustability
- Weight Capacity: 1,000 lbs

Cat. No.	Dimensions (W x D x H)
24" Deep	
JHDPAT-4824NT	48" x 24" x 36"
JHDPAT-6024NT	60" x 24" x 36"
JHDPAT-7224NT	72" x 24" x 36"
JHDPAT-8424NT	84" x 24" x 36"
JHDPAT-9624NT	96" x 24" x 36"
30" Deep	
JHDPAT-4830NT	48" x 30" x 36"
JHDPAT-6030NT	60" x 30" x 36"
JHDPAT-7230NT	72" x 30" x 36"
JHDPAT-8430NT	84" x 30" x 36"
JHDPAT-9630NT	96" x 30" x 36"
36" Deep	
JHDPAT-4836NT	48" x 36" x 36"
JHDPAT-6036NT	60" x 36" x 36"
JHDPAT-7236NT	72" x 36" x 36"
JHDPAT-8436NT	84" x 36" x 36"
JHDPAT-9636NT	96" x 36" x 36"

Add Locking Swivel Casters to Heavy Duty Table

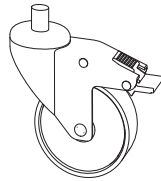

- (4) 4" Locking Swivel Casters
- Weight Capacity: 1,000 lbs

Cat. No.	Type
PAT-C	(4) Locking Swivel Casters

Add Leveling Casters to Heavy Duty

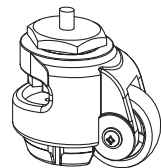

- (4) Leveling Caster has a disc style leveling function
- Weight Capacity: 1,000 lbs

Cat. No.	Type
E3HD-KIT	(4) Leveling Casters

Heavy Duty Table

Phenolic Work Surface for Heavy Duty Table

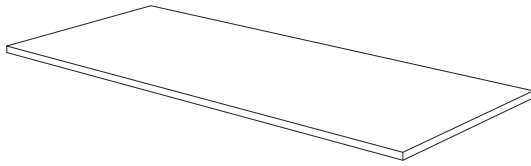

- 1" thick black phenolic resin work surface
- See page 13 for table frame

Cat. No.	Depth	Width
24" Deep		
JHDPAT-4824PRT	24"	48"
JHDPAT-6024PRT	24"	60"
JHDPAT-7224PRT	24"	72"
JHDPAT-8424PRT	24"	84"
JHDPAT-9624PRT	24"	96"
30" Deep		
JHDPAT-4830PRT	30"	48"
JHDPAT-6030PRT	30"	60"
JHDPAT-7230PRT	30"	72"
JHDPAT-8430PRT	30"	84"
JHDPAT-9630PRT	30"	96"
36" Deep		
JHDPAT-4836PRT	36"	48"
JHDPAT-6036PRT	36"	60"
JHDPAT-7236PRT	36"	72"
JHDPAT-8436PRT	36"	84"
JHDPAT-9636PRT	36"	96"

Epoxy Work Surface for Heavy Duty Table

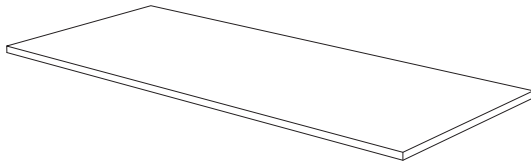

- 1" thick black epoxy work surface
- See page 13 for table frame

Cat. No.	Depth	Width
24" Deep		
JHDPAT-4824ERT	24"	48"
JHDPAT-6024ERT	24"	60"
JHDPAT-7224ERT	24"	72"
JHDPAT-8424ERT	24"	84"
JHDPAT-9624ERT	24"	96"
30" Deep		
JHDPAT-4830ERT	30"	48"
JHDPAT-6030ERT	30"	60"
JHDPAT-7230ERT	30"	72"
JHDPAT-8430ERT	30"	84"
JHDPAT-9630ERT	30"	96"
36" Deep		
JHDPAT-4836ERT	36"	48"
JHDPAT-6036ERT	36"	60"
JHDPAT-7236ERT	36"	72"
JHDPAT-8436ERT	36"	84"
JHDPAT-9636ERT	36"	96"

Pre-Mount for a Work Surface

- Use this part number to mount a work surface

Cat. No.	Type
PAT-PMP	Pre-mount for Phenolic Work Surface
PAT-PME	Pre-mount for Epoxy Work Surface

Envision 3.0

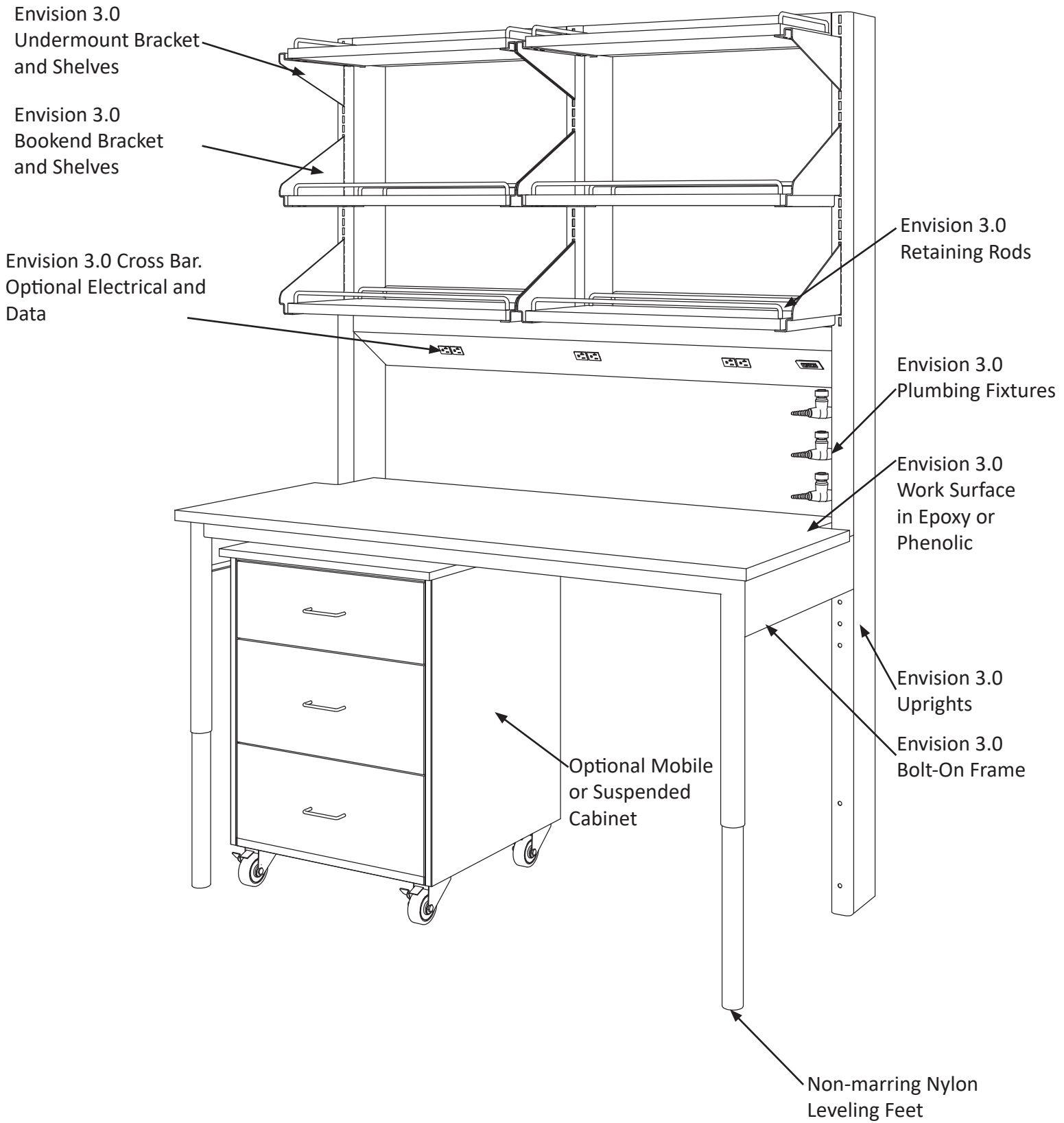

Envision 3.0 - 3" Uprights with Plumbing Cutouts Only

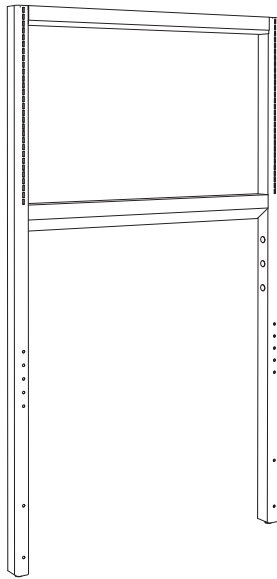

E3U3B-48R

- Uprights are 3" Deep Envision 3.0, Single Sided
- Heights is 84"
- Upright with a width greater than 48" has a center upright
- For Stainless Steel contact your ICI representative

Includes:

- (3) plumbing cutouts on the noted side

Cat. No.		Width
Left Hand Plumbing	Right Hand Plumbing	
E3U3B-42L	E3U3B-42R	42"
E3U3B-48L	E3U3B-48R	48"
E3U3B-60L	E3U3B-60R	60"
E3U3B-72L	E3U3B-72R	72"
E3U3B-84L	E3U3B-84R	84"
E3U3B-96L	E3U3B-96R	96"

Envision 3.0 - 3" Uprights with Plumbing and Data Cutouts Only

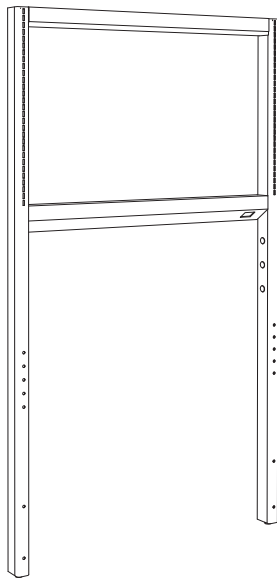

E3U3D-48R

- Uprights are 3" Deep Envision 3.0, Single Sided
- Heights is 84"
- Upright with a width greater than 48" has a center upright
- For Stainless Steel contact your ICI representative

Includes:

- (3) plumbing cutouts on the noted side
- (1) data cutout on cross bar on same side as plumbing cutouts

Cat. No.		Width
Left Hand Plumbing	Right Hand Plumbing	
E3U3D-42L	E3U3D-42R	42"
E3U3D-48L	E3U3D-48R	48"
E3U3D-60L	E3U3D-60R	60"
E3U3D-72L	E3U3D-72R	72"
E3U3D-84L	E3U3D-84R	84"
E3U3D-96L	E3U3D-96R	96"

Envision 3.0

Envision 3.0 - 3" Uprights with Plumbing, Data, and Standard Electric Cutouts Only

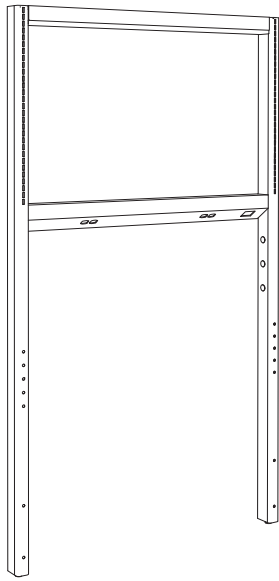

E3U3DE-48R

- Uprights are 3" Deep Envision 3.0, Single Sided
- Heights is 84"
- Upright with a width greater than 48" has a center upright
- For Stainless Steel contact your ICI representative

Includes:

- (3) plumbing cutouts on the noted side
- (1) data cutout on cross bar on same side as plumbing cutouts
- 42" - 48" wide uprights have (2) standard electric cutouts on cross bar
- 60" - 96" wide uprights have (3) standard electric cutouts on cross bar
- (1) standard electric cutout on post opposite plumbing

Cat. No.		Width
Left Hand Plumbing	Right Hand Plumbing	
E3U3DE-42L	E3U3DE-42R	42"
E3U3DE-48L	E3U3DE-48R	48"
E3U3DE-60L	E3U3DE-60R	60"
E3U3DE-72L	E3U3DE-72R	72"
E3U3DE-84L	E3U3DE-84R	84"
E3U3DE-96L	E3U3DE-96R	96"

Envision 3.0 - 3" Uprights with Plumbing, Data, and Standard & GFI Electric Cutouts Only

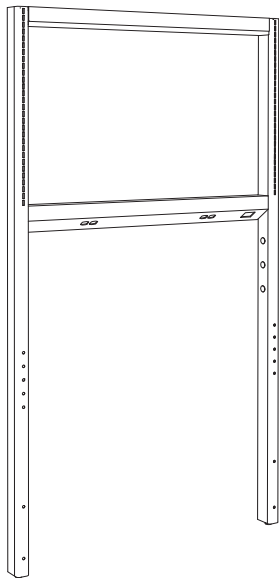

E3U3DEG-48R

- Uprights are 3" Deep Envision 3.0, Single Sided
- Heights is 84"
- Upright with a width greater than 48" has a center upright
- For Stainless Steel contact your ICI representative

Includes:

- (3) plumbing cutouts on the noted side
- (1) data cutout on cross bar on same side as plumbing cutouts
- 42" - 48" wide uprights have (2) standard electric cutouts on cross bar
- 60" - 96" wide uprights have (3) standard electric cutouts on cross bar
- (1) GFI electric cutout on post opposite plumbing

Cat. No.		Width
Left Hand Plumbing	Right Hand Plumbing	
E3U3DEG-42L	E3U3DEG-42R	42"
E3U3DEG-48L	E3U3DEG-48R	48"
E3U3DEG-60L	E3U3DEG-60R	60"
E3U3DEG-72L	E3U3DEG-72R	72"
E3U3DEG-84L	E3U3DEG-84R	84"
E3U3DEG-96L	E3U3DEG-96R	96"

Envision 3.0 - 3" Uprights with Plumbing, and Standard Electric Cutouts Only

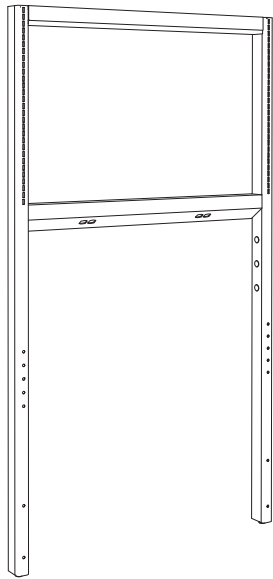

E3U3E-48R

- Uprights are 3" Deep Envision 3.0, Single Sided
- Heights is 84"
- Upright with a width greater than 48" has a center upright
- For Stainless Steel contact your ICI representative

Includes:

- (3) plumbing cutouts on the noted side
- 42" - 48" wide uprights have (2) standard electric cutouts on cross bar
- 60" - 96" wide uprights have (3) standard electric cutouts on cross bar
- (1) standard electric cutout on post opposite plumbing

Cat. No.		Width
Left Hand Plumbing	Right Hand Plumbing	
E3U3E-42L	E3U3E-42R	42"
E3U3E-48L	E3U3E-48R	48"
E3U3E-60L	E3U3E-60R	60"
E3U3E-72L	E3U3E-72R	72"
E3U3E-84L	E3U3E-84R	84"
E3U3E-96L	E3U3E-96R	96"

Envision 3.0 - 3" Uprights with Plumbing, and Standard & GFI Electric Cutouts Only

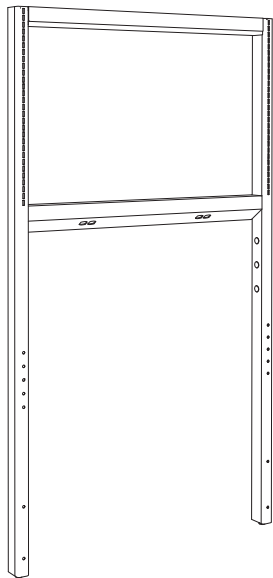

E3U3E-48R

- Uprights are 3" Deep Envision 3.0, Single Sided
- Heights is 84"
- Upright with a width greater than 48" has a center upright
- For Stainless Steel contact your ICI representative

Includes:

- (3) plumbing cutouts on the noted side
- 42" - 48" wide uprights have (2) standard electric cutouts on cross bar
- 60" - 96" wide uprights have (3) standard electric cutouts on cross bar
- (1) GFI electric cutout on post opposite plumbing

Cat. No.		Width
Left Hand Plumbing	Right Hand Plumbing	
E3U3EG-42L	E3U3EG-42R	42"
E3U3EG-48L	E3U3EG-48R	48"
E3U3EG-60L	E3U3EG-60R	60"
E3U3EG-72L	E3U3EG-72R	72"
E3U3EG-84L	E3U3EG-84R	84"
E3U3EG-96L	E3U3EG-96R	96"

Envision 3.0

Envision 3.0 - 6" Uprights with Plumbing Cutouts Only

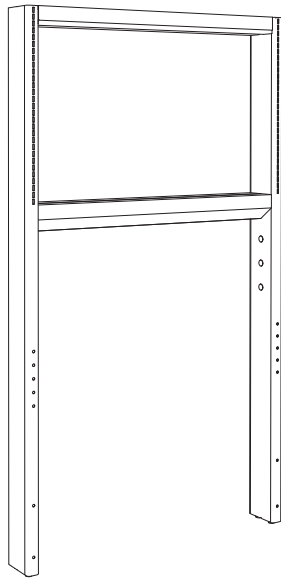

E3U6B-48

- Uprights are 6" Deep Envision 3.0, Double Sided
- Heights is 84"
- Upright with a width greater than 48" has a center upright
- For Stainless Steel contact your ICI representative

Includes:

- (3) plumbing cutouts on one side

Cat. No.	Width
E3U6B-42	42"
E3U6B-48	48"
E3U6B-60	60"
E3U6B-72	72"
E3U6B-84	84"
E3U6B-96	96"

Envision 3.0 - 6" Uprights with Plumbing, and Data Cutouts Only

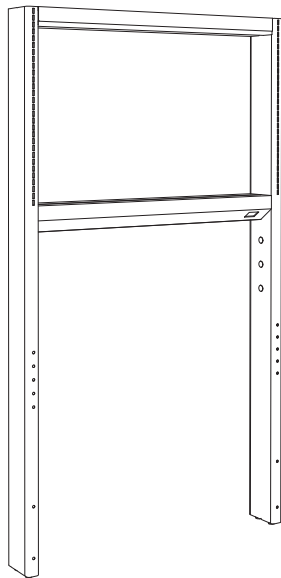

E3U6D-48

- Uprights are 6" Deep Envision 3.0, Double Sided
- Heights is 84"
- Upright with a width greater than 48" has a center upright
- For Stainless Steel contact your ICI representative

Includes:

- (3) plumbing cutouts on one side
- (1) data cutout on cross bar on same side as plumbing cutouts

Cat. No.	Width
E3U6D-42	42"
E3U6D-48	48"
E3U6D-60	60"
E3U6D-72	72"
E3U6D-84	84"
E3U6D-96	96"

Envision 3.0 - 6" Uprights with Plumbing, Data, and Standard Electric Cutouts Only

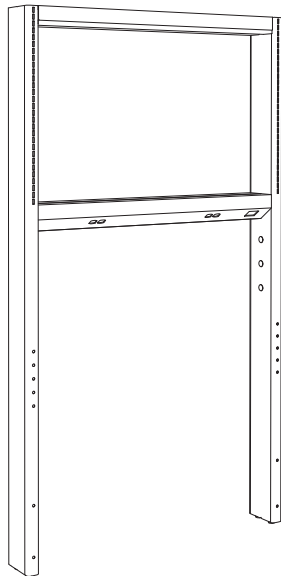

E3U6DE-48

- Uprights are 6" Deep Envision 3.0, Double Sided
- Heights is 84"
- Upright with a width greater than 48" has a center upright
- For Stainless Steel contact your ICI representative

Includes:

- (3) plumbing cutouts on one side
- (1) data cutout on cross bar on same side as plumbing cutouts
- 42" - 48" wide uprights have (4) standard electric cutouts on cross bar
- 60" - 96" wide uprights have (6) standard electric cutouts on cross bar
- (2) standard electric cutout on opposite post as the plumbing cutouts

Cat. No.	Width
E3U6DE-42	42"
E3U6DE-48	48"
E3U6DE-60	60"
E3U6DE-72	72"
E3U6DE-84	84"
E3U6DE-96	96"

Envision 3.0 - 6" Uprights with Plumbing, Data, and Standard & GFI Electric Cutouts Only

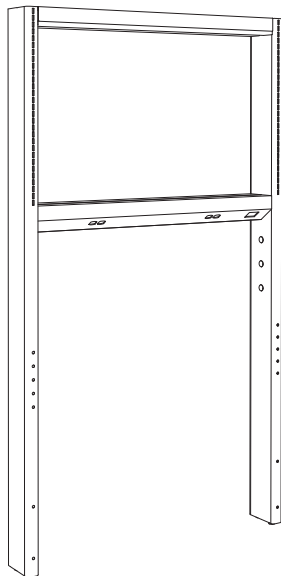

E3U6DEG-48

- Uprights are 6" Deep Envision 3.0, Double Sided
- Heights is 84"
- Upright with a width greater than 48" has a center upright
- For Stainless Steel contact your ICI representative

Includes:

- (3) plumbing cutouts on one side
- (1) data cutout on cross bar on same side as plumbing cutouts
- 42" - 48" wide uprights have (4) standard electric cutouts on cross bar
- 60" - 96" wide uprights have (6) standard electric cutouts on cross bar
- (2) GFI electric cutout on opposite post as the plumbing cutouts

Cat. No.	Width
E3U6DEG-42	42"
E3U6DEG-48	48"
E3U6DEG-60	60"
E3U6DEG-72	72"
E3U6DEG-84	84"
E3U6DEG-96	96"

Envision 3.0

Envision 3.0 - 6" Uprights with Plumbing, and Standard Electric Cutouts Only

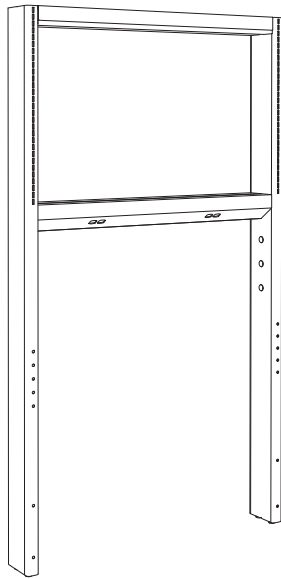

E3U6E-48

- Uprights are 6" Deep Envision 3.0, Double Sided
- Heights is 84"
- Upright with a width greater than 48" has a center upright
- For Stainless Steel contact your ICI representative

Includes:

- (3) plumbing cutouts on one side
- 42" - 48" wide uprights have (4) standard electric cutouts on cross bar
- 60" - 96" wide uprights have (6) standard electric cutouts on cross bar
- (2) standard electric cutout on opposite post as the plumbing cutouts

Cat. No.	Width
E3U6E-42	42"
E3U6E-48	48"
E3U6E-60	60"
E3U6E-72	72"
E3U6E-84	84"
E3U6E-96	96"

Envision 3.0 - 6" Uprights with Plumbing, and Standard & GFI Electric Cutouts Only

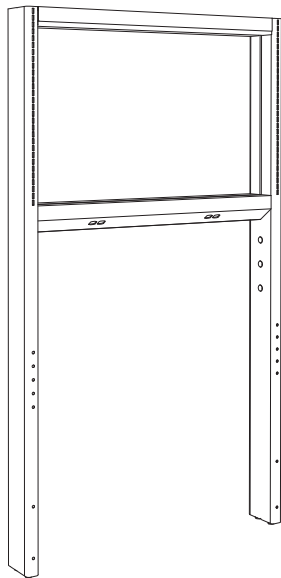

E3U6EG-48

- Uprights are 6" Deep Envision 3.0, Double Sided
- Heights is 84"
- Upright with a width greater than 48" has a center upright
- For Stainless Steel contact your ICI representative

Includes:

- (3) plumbing cutouts on one side
- 42" - 48" wide uprights have (4) standard electric cutouts on cross bar
- 60" - 96" wide uprights have (6) standard electric cutouts on cross bar
- (2) GFI electric cutout on opposite post as the plumbing cutouts

Cat. No.	Width
E3U6EG-42	42"
E3U6EG-48	48"
E3U6EG-60	60"
E3U6EG-72	72"
E3U6EG-84	84"
E3U6EG-96	96"

Envision 3.0 - Bolt-on Frame - 3" Upright Single Sided

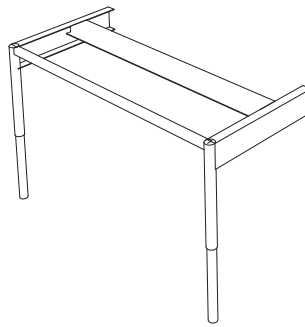
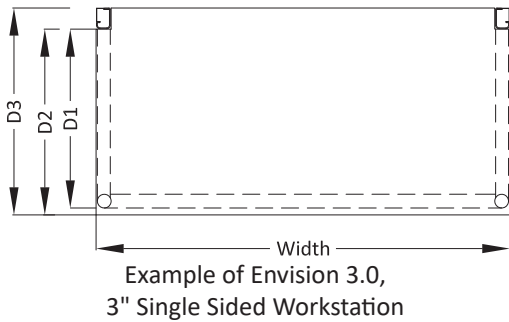

- Envision 3.0 Bolt-On Frames are to be attached to any Envision 3.0 uprights
- Only (1) Bolt-On Frame can be attached to a 3" upright
- (2) Bolt-On Frames can be attached to 6" uprights to make a double sided workstation
- Adjustable Height work surface frame from 30 1/4" - 36 1/4", in 2" increments
- For Stainless Steel, contact your ICI Representative
- Work Surface ordered separately
- Work Surface depth details listed below see page 27 for work surface part numbers

Bolt-on Frame Cat. No.	Depth of Bolt-on Frame (D1)	Nominal Depth of Bolt-on Frame (D2)	Depth of Work Surface with 3" Notch (D3)	Width
Nominal 21" Deep				
E3CTFB-2142	20"	21"	24"	42"
E3CTFB-2148	20"	21"	24"	48"
E3CTFB-2160	20"	21"	24"	60"
E3CTFB-2172	20"	21"	24"	72"
E3CTFB-2184	20"	21"	24"	84"
E3CTFB-2196	20"	21"	24"	96"
Nominal 24" Deep				
E3CTFB-2442	23"	24"	27"	42"
E3CTFB-2448	23"	24"	27"	48"
E3CTFB-2460	23"	24"	27"	60"
E3CTFB-2472	23"	24"	27"	72"
E3CTFB-2484	23"	24"	27"	84"
E3CTFB-2496	23"	24"	27"	96"
Nominal 27" Deep				
E3CTFB-2742	26"	27"	30"	42"
E3CTFB-2748	26"	27"	30"	48"
E3CTFB-2760	26"	27"	30"	60"
E3CTFB-2772	26"	27"	30"	72"
E3CTFB-2784	26"	27"	30"	84"
E3CTFB-2796	26"	27"	30"	96"
Nominal 30" Deep				
E3CTFB-3042	29"	30"	33"	42"
E3CTFB-3048	29"	30"	33"	48"
E3CTFB-3060	29"	30"	33"	60"
E3CTFB-3072	29"	30"	33"	72"
E3CTFB-3084	29"	30"	33"	84"
E3CTFB-3096	29"	30"	33"	96"
Nominal 33" Deep				
E3CTFB-3342	32"	33"	36"	42"
E3CTFB-3348	32"	33"	36"	48"
E3CTFB-3360	32"	33"	36"	60"
E3CTFB-3372	32"	33"	36"	72"
E3CTFB-3384	32"	33"	36"	84"
E3CTFB-3396	32"	33"	36"	96"

Envision 3.0

Envision 3.0 - Bolt-On and Table - 3" Uprights Double Sided

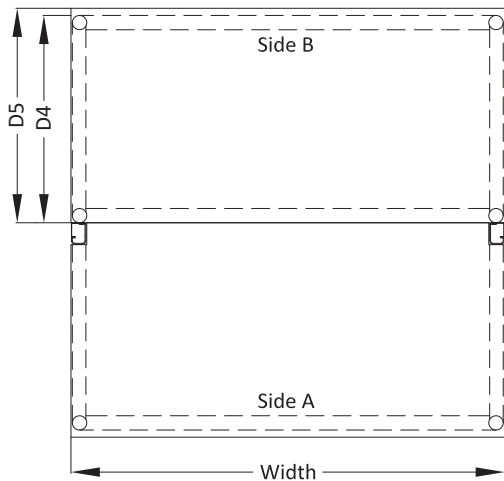

Example of Envision 3.0,
3" Upright Double Sided Workstation

- Envision 3.0 Tables are to be used to make a double sided workstation with a 3" or 6" upright
- Envision 3.0 Tables can also be free standing tables
- Adjustable Height work surface frame from 30 1/4" - 36 1/4", in 2" increments
- For Stainless Steel, contact your ICI Representative
- Work Surface ordered separately
- Work Surface depth details for Side A listed on previous page
- Work Surface depth details for Side B listed below see page 29 for work surface part numbers

Bolt-on Frame Cat. No.	Depth of Frame/Table (D4)	Depth of Work Surface with No Notch (D5)	Width	Bolt-on Frame Cat. No.	Depth of Frame/Table (D4)	Depth of Work Surface with No Notch (D5)	Width
Nominal 15" Deep				Nominal 27" Deep			
E3CTFT-1542	14"	15"	42"	E3CTFT-2742	26"	27"	42"
E3CTFT-1548	14"	15"	48"	E3CTFT-2748	26"	27"	48"
E3CTFT-1560	14"	15"	60"	E3CTFT-2760	26"	27"	60"
E3CTFT-1572	14"	15"	72"	E3CTFT-2772	26"	27"	72"
E3CTFT-1584	14"	15"	84"	E3CTFT-2784	26"	27"	84"
E3CTFT-1596	14"	15"	96"	E3CTFT-2796	26"	27"	96"
Nominal 18" Deep				Nominal 30" Deep			
E3CTFT-1842	17"	18"	42"	E3CTFT-3042	29"	30"	42"
E3CTFT-1848	17"	18"	48"	E3CTFT-3048	29"	30"	48"
E3CTFT-1860	17"	18"	60"	E3CTFT-3060	29"	30"	60"
E3CTFT-1872	17"	18"	72"	E3CTFT-3072	29"	30"	72"
E3CTFT-1884	17"	18"	84"	E3CTFT-3084	29"	30"	84"
E3CTFT-1896	17"	18"	96"	E3CTFT-3096	29"	30"	96"
Nominal 19" Deep				Nominal 33" Deep			
E3CTFT-1942	18"	19"	42"	E3CTFT-3342	32"	33"	42"
E3CTFT-1948	18"	19"	48"	E3CTFT-3348	32"	33"	48"
E3CTFT-1960	18"	19"	60"	E3CTFT-3360	32"	33"	60"
E3CTFT-1972	18"	19"	72"	E3CTFT-3372	32"	33"	72"
E3CTFT-1984	18"	19"	84"	E3CTFT-3384	32"	33"	84"
E3CTFT-1996	18"	19"	96"	E3CTFT-3396	32"	33"	96"
Nominal 21" Deep				Nominal 36" Deep			
E3CTFT-2142	20"	21"	42"	E3CTFT-3642	35"	36"	42"
E3CTFT-2148	20"	21"	48"	E3CTFT-3648	35"	36"	48"
E3CTFT-2160	20"	21"	60"	E3CTFT-3660	35"	36"	60"
E3CTFT-2172	20"	21"	72"	E3CTFT-3672	35"	36"	72"
E3CTFT-2184	20"	21"	84"	E3CTFT-3684	35"	36"	84"
E3CTFT-2196	20"	21"	96"	E3CTFT-3696	35"	36"	96"
Nominal 24" Deep							
E3CTFT-2442	23"	24"	42"				
E3CTFT-2448	23"	24"	48"				
E3CTFT-2460	23"	24"	60"				
E3CTFT-2472	23"	24"	72"				
E3CTFT-2484	23"	24"	84"				
E3CTFT-2496	23"	24"	96"				

Envision 3.0 - Bolt-On Frame - 6" Uprights Double Sided

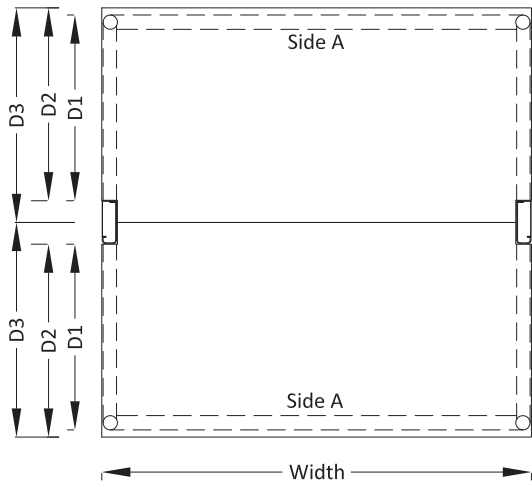

Example of Envision 3.0,
6" Upright Double Sided Workstation with (2)
Bolt-on Frames

- Envision 3.0 Bolt-On Frames are to be attached to any Envision 3.0 uprights
- Only (1) Bolt-On Frame can be attached to a 3" upright
- (2) Bolt-On Frames can be attached to 6" uprights to make a double sided workstation
- Adjustable Height work surface frame from 30 1/4" - 36 1/4", in 2" increments
- For Stainless Steel, contact your ICI Representative
- Work Surface depth details for Side B listed on previous page
- Work Surface depth details for Side A listed below see page 27 for work surface part numbers

Bolt-on Frame Cat. No.	Depth of Bolt-on Frame (D1)	Nominal Depth of Bolt-on Frame (D2)	Depth of Work Surface with 3" Notch (D3)	Width
Nominal 21" Deep				
E3CTFB-2142	20"	21"	24"	42"
E3CTFB-2148	20"	21"	24"	48"
E3CTFB-2160	20"	21"	24"	60"
E3CTFB-2172	20"	21"	24"	72"
E3CTFB-2184	20"	21"	24"	84"
E3CTFB-2196	20"	21"	24"	96"
Nominal 24" Deep				
E3CTFB-2442	23"	24"	27"	42"
E3CTFB-2448	23"	24"	27"	48"
E3CTFB-2460	23"	24"	27"	60"
E3CTFB-2472	23"	24"	27"	72"
E3CTFB-2484	23"	24"	27"	84"
E3CTFB-2496	23"	24"	27"	96"
Nominal 27" Deep				
E3CTFB-2742	26"	27"	30"	42"
E3CTFB-2748	26"	27"	30"	48"
E3CTFB-2760	26"	27"	30"	60"
E3CTFB-2772	26"	27"	30"	72"
E3CTFB-2784	26"	27"	30"	84"
E3CTFB-2796	26"	27"	30"	96"
Nominal 30" Deep				
E3CTFB-3042	29"	30"	33"	42"
E3CTFB-3048	29"	30"	33"	48"
E3CTFB-3060	29"	30"	33"	60"
E3CTFB-3072	29"	30"	33"	72"
E3CTFB-3084	29"	30"	33"	84"
E3CTFB-3096	29"	30"	33"	96"
Nominal 33" Deep				
E3CTFB-3342	32"	33"	36"	42"
E3CTFB-3348	32"	33"	36"	48"
E3CTFB-3360	32"	33"	36"	60"
E3CTFB-3372	32"	33"	36"	72"
E3CTFB-3384	32"	33"	36"	84"
E3CTFB-3396	32"	33"	36"	96"

Envision 3.0

Envision 3.0 - Bolt-On and Table - 6" Uprights Double Sided

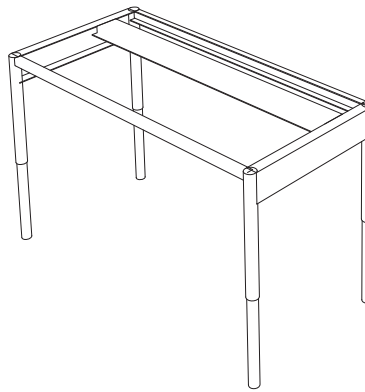
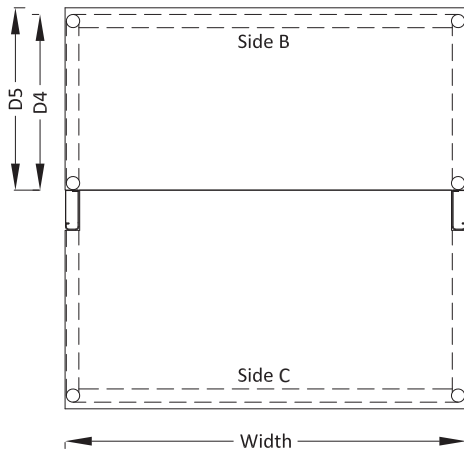

- Envision 3.0 Tables are to be used to make a double sided workstation with a 3" or 6" upright
- Envision 3.0 Tables can also be free standing tables
- Adjustable Height work surface frame from 30 1/4" - 36 1/4", in 2" increments
- For Stainless Steel, contact your ICI Representative
- Work Surface ordered separately
- Work Surface depth details for Side C listed on next page
- Work Surface depth details for Side B listed below see page 29 for work surface part numbers

Example of Envision 3.0,
6" Upright Double Sided Workstation with (1)
Bolt-on and (1) Table

Bolt-on Frame Cat. No.	Depth of Frame/Table (D4)	Depth of Work Surface with No Notch (D5)	Width	Bolt-on Frame Cat. No.	Depth of Frame/Table (D4)	Depth of Work Surface with No Notch (D5)	Width
Nominal 15" Deep				Nominal 27" Deep			
E3CTFT-1542	14"	15"	42"	E3CTFT-2742	26"	27"	42"
E3CTFT-1548	14"	15"	48"	E3CTFT-2748	26"	27"	48"
E3CTFT-1560	14"	15"	60"	E3CTFT-2760	26"	27"	60"
E3CTFT-1572	14"	15"	72"	E3CTFT-2772	26"	27"	72"
E3CTFT-1584	14"	15"	84"	E3CTFT-2784	26"	27"	84"
E3CTFT-1596	14"	15"	96"	E3CTFT-2796	26"	27"	96"
Nominal 18" Deep				Nominal 30" Deep			
E3CTFT-1842	17"	18"	42"	E3CTFT-3042	29"	30"	42"
E3CTFT-1848	17"	18"	48"	E3CTFT-3048	29"	30"	48"
E3CTFT-1860	17"	18"	60"	E3CTFT-3060	29"	30"	60"
E3CTFT-1872	17"	18"	72"	E3CTFT-3072	29"	30"	72"
E3CTFT-1884	17"	18"	84"	E3CTFT-3084	29"	30"	84"
E3CTFT-1896	17"	18"	96"	E3CTFT-3096	29"	30"	96"
Nominal 19" Deep				Nominal 33" Deep			
E3CTFT-1942	18"	19"	42"	E3CTFT-3342	32"	33"	42"
E3CTFT-1948	18"	19"	48"	E3CTFT-3348	32"	33"	48"
E3CTFT-1960	18"	19"	60"	E3CTFT-3360	32"	33"	60"
E3CTFT-1972	18"	19"	72"	E3CTFT-3372	32"	33"	72"
E3CTFT-1984	18"	19"	84"	E3CTFT-3384	32"	33"	84"
E3CTFT-1996	18"	19"	96"	E3CTFT-3396	32"	33"	96"
Nominal 21" Deep				Nominal 36" Deep			
E3CTFT-2142	20"	21"	42"	E3CTFT-3642	35"	36"	42"
E3CTFT-2148	20"	21"	48"	E3CTFT-3648	35"	36"	48"
E3CTFT-2160	20"	21"	60"	E3CTFT-3660	35"	36"	60"
E3CTFT-2172	20"	21"	72"	E3CTFT-3672	35"	36"	72"
E3CTFT-2184	20"	21"	84"	E3CTFT-3684	35"	36"	84"
E3CTFT-2196	20"	21"	96"	E3CTFT-3696	35"	36"	96"
Nominal 24" Deep							
E3CTFT-2442	23"	24"	42"				
E3CTFT-2448	23"	24"	48"				
E3CTFT-2460	23"	24"	60"				
E3CTFT-2472	23"	24"	72"				
E3CTFT-2484	23"	24"	84"				
E3CTFT-2496	23"	24"	96"				

Envision 3.0 - Bolt-On and Table - 6" Uprights Double Sided

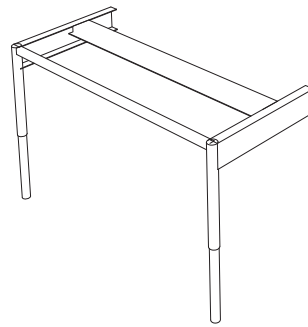
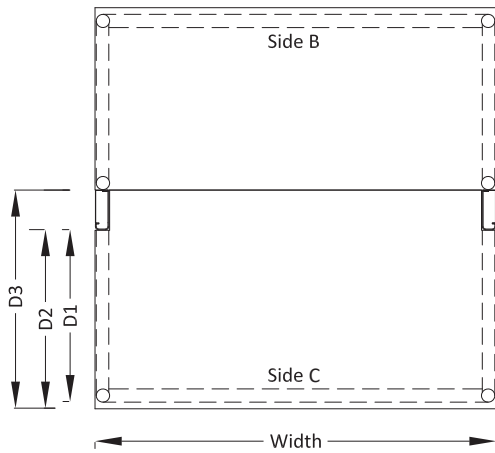

- Envision 3.0 Bolt-On Frames are to be attached to any Envision 3.0 uprights
- Only (1) Bolt-On Frame can be attached to a 3" upright
- (2) Bolt-On Frames can be attached to 6" uprights to make a double sided workstation
- Adjustable Height work surface frame from 30 1/4" - 36 1/4", in 2" increments
- For Stainless Steel, contact your ICI Representative
- Work Surface depth details for Side B listed on previous page
- Work Surface depth details for Side A listed below see page 28 for work surface part numbers

Example of Envision 3.0, 6" Upright Double Sided Workstation with (1) Bolt-on and (1) Table

Bolt-on Frame Cat. No.	Depth of Bolt-on Frame (D1)	Nominal Depth of Bolt-on Frame (D2)	Depth of Work Surface with 6" Notch (D3)	Width
Nominal 21" Deep				
E3CTFB-2142	20"	21"	27"	42"
E3CTFB-2148	20"	21"	27"	48"
E3CTFB-2160	20"	21"	27"	60"
E3CTFB-2172	20"	21"	27"	72"
E3CTFB-2184	20"	21"	27"	84"
E3CTFB-2196	20"	21"	27"	96"
Nominal 24" Deep				
E3CTFB-2442	23"	24"	30"	42"
E3CTFB-2448	23"	24"	30"	48"
E3CTFB-2460	23"	24"	30"	60"
E3CTFB-2472	23"	24"	30"	72"
E3CTFB-2484	23"	24"	30"	84"
E3CTFB-2496	23"	24"	30"	96"
Nominal 27" Deep				
E3CTFB-2742	26"	27"	33"	42"
E3CTFB-2748	26"	27"	33"	48"
E3CTFB-2760	26"	27"	33"	60"
E3CTFB-2772	26"	27"	33"	72"
E3CTFB-2784	26"	27"	33"	84"
E3CTFB-2796	26"	27"	33"	96"
Nominal 30" Deep				
E3CTFB-3042	29"	30"	36"	42"
E3CTFB-3048	29"	30"	36"	48"
E3CTFB-3060	29"	30"	36"	60"
E3CTFB-3072	29"	30"	36"	72"
E3CTFB-3084	29"	30"	36"	84"
E3CTFB-3096	29"	30"	36"	96"

Envision 3.0

Envision 3.0 - 3" Upright Notched Work Surface

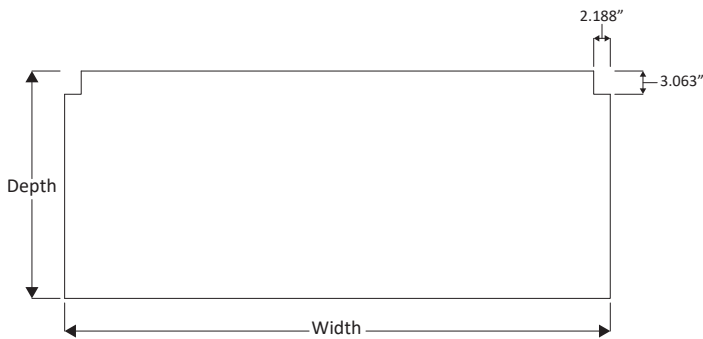

- This work surface is to be used with Envision 3.0, 3" upright or (2) ea on a 6" double sided upright

Epoxy	Cat. No. Phenolic	Stainless Steel	Width
24" Deep Top			
E3CT1ER3-2442	E3CT1PH3-2442	E3CT1SS3-2442	42"
E3CT1ER3-2448	E3CT1PH3-2448	E3CT1SS3-2448	48"
E3CT1ER3-2460	E3CT1PH3-2460	E3CT1SS3-2460	60"
E3CT1ER3-2472	E3CT1PH3-2472	E3CT1SS3-2472	72"
E3CT1ER3-2484	E3CT1PH3-2484	E3CT1SS3-2484	84"
E3CT1ER3-2496	E3CT1PH3-2496	E3CT1SS3-2496	96"
27" Deep Top			
E3CT1ER3-2742	E3CT1PH3-2742	E3CT1SS3-2742	42"
E3CT1ER3-2748	E3CT1PH3-2748	E3CT1SS3-2748	48"
E3CT1ER3-2760	E3CT1PH3-2760	E3CT1SS3-2760	60"
E3CT1ER3-2772	E3CT1PH3-2772	E3CT1SS3-2772	72"
E3CT1ER3-2784	E3CT1PH3-2784	E3CT1SS3-2784	84"
E3CT1ER3-2796	E3CT1PH3-2796	E3CT1SS3-2796	96"
30" Deep Top			
E3CT1ER3-3042	E3CT1PH3-3042	E3CT1SS3-3042	42"
E3CT1ER3-3048	E3CT1PH3-3048	E3CT1SS3-3048	48"
E3CT1ER3-3060	E3CT1PH3-3060	E3CT1SS3-3060	60"
E3CT1ER3-3072	E3CT1PH3-3072	E3CT1SS3-3072	72"
E3CT1ER3-3084	E3CT1PH3-3084	E3CT1SS3-3084	84"
E3CT1ER3-3096	E3CT1PH3-3096	E3CT1SS3-3096	96"
33" Deep Top			
E3CT1ER3-3342	E3CT1PH3-3342	E3CT1SS3-3342	42"
E3CT1ER3-3348	E3CT1PH3-3348	E3CT1SS3-3348	48"
E3CT1ER3-3360	E3CT1PH3-3360	E3CT1SS3-3360	60"
E3CT1ER3-3372	E3CT1PH3-3372	E3CT1SS3-3372	72"
E3CT1ER3-3384	E3CT1PH3-3384	E3CT1SS3-3384	84"
E3CT1ER3-3396	E3CT1PH3-3396	E3CT1SS3-3396	96"
36" Deep Top			
E3CT1ER3-3642	E3CT1PH3-3642	E3CT1SS3-3642	42"
E3CT1ER3-3648	E3CT1PH3-3648	E3CT1SS3-3648	48"
E3CT1ER3-3660	E3CT1PH3-3660	E3CT1SS3-3660	60"
E3CT1ER3-3672	E3CT1PH3-3672	E3CT1SS3-3672	72"
E3CT1ER3-3684	E3CT1PH3-3684	E3CT1SS3-3684	84"
E3CT1ER3-3696	E3CT1PH3-3696	E3CT1SS3-3696	96"

Envision 3.0 - 6" Upright Notched Work Surface

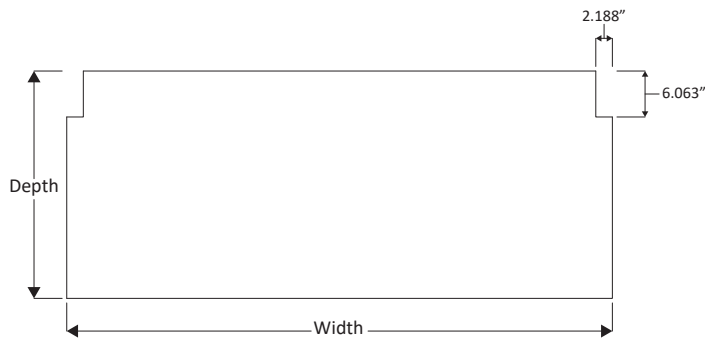

- This work surface is to be used with Envision 3.0, 6" upright

Epoxy	Cat. No. Phenolic	Stainless Steel	Width
27" Deep Top			
E3CT1ER6-2742	E3CT1PH6-2742	E3CT1SS6-2742	42"
E3CT1ER6-2748	E3CT1PH6-2748	E3CT1SS6-2748	48"
E3CT1ER6-2760	E3CT1PH6-2760	E3CT1SS6-2760	60"
E3CT1ER6-2772	E3CT1PH6-2772	E3CT1SS6-2772	72"
E3CT1ER6-2784	E3CT1PH6-2784	E3CT1SS6-2784	84"
E3CT1ER6-2796	E3CT1PH6-2796	E3CT1SS6-2796	96"
30" Deep Top			
E3CT1ER6-3042	E3CT1PH6-3042	E3CT1SS6-3042	42"
E3CT1ER6-3048	E3CT1PH6-3048	E3CT1SS6-3048	48"
E3CT1ER6-3060	E3CT1PH6-3060	E3CT1SS6-3060	60"
E3CT1ER6-3072	E3CT1PH6-3072	E3CT1SS6-3072	72"
E3CT1ER6-3084	E3CT1PH6-3084	E3CT1SS6-3084	84"
E3CT1ER6-3096	E3CT1PH6-3096	E3CT1SS6-3096	96"
33" Deep Top			
E3CT1ER6-3342	E3CT1PH6-3342	E3CT1SS6-3342	42"
E3CT1ER6-3348	E3CT1PH6-3348	E3CT1SS6-3348	48"
E3CT1ER6-3360	E3CT1PH6-3360	E3CT1SS6-3360	60"
E3CT1ER6-3372	E3CT1PH6-3372	E3CT1SS6-3372	72"
E3CT1ER6-3384	E3CT1PH6-3384	E3CT1SS6-3384	84"
E3CT1ER6-3396	E3CT1PH6-3396	E3CT1SS6-3396	96"
36" Deep Top			
E3CT1ER6-3642	E3CT1PH6-3642	E3CT1SS6-3642	42"
E3CT1ER6-3648	E3CT1PH6-3648	E3CT1SS6-3648	48"
E3CT1ER6-3660	E3CT1PH6-3660	E3CT1SS6-3660	60"
E3CT1ER6-3672	E3CT1PH6-3672	E3CT1SS6-3672	72"
E3CT1ER6-3684	E3CT1PH6-3684	E3CT1SS6-3684	84"
E3CT1ER6-3696	E3CT1PH6-3696	E3CT1SS6-3696	96"

Envision 3.0

Envision 3.0 - No Notch Work Surface

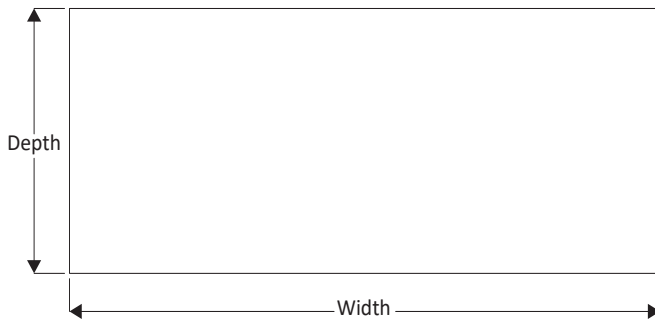

- This work surface is to be used with an Envision 3.0 Table

15" Deep Top				27" Deep Top			
Epoxy	Cat. No. Phenolic	Stainless Steel	Width	Epoxy	Cat. No. Phenolic	Stainless Steel	Width
E3CT1ERT-1542	E3CT1PHT-1542	E3CT1SST-1542	42"	E3CT1ERT-2742	E3CT1PHT-2742	E3CT1SST-2742	42"
E3CT1ERT-1548	E3CT1PHT-1548	E3CT1SST-1548	48"	E3CT1ERT-2748	E3CT1PHT-2748	E3CT1SST-2748	48"
E3CT1ERT-1560	E3CT1PHT-1560	E3CT1SST-1560	60"	E3CT1ERT-2760	E3CT1PHT-2760	E3CT1SST-2760	60"
E3CT1ERT-1572	E3CT1PHT-1572	E3CT1SST-1572	72"	E3CT1ERT-2772	E3CT1PHT-2772	E3CT1SST-2772	72"
E3CT1ERT-1584	E3CT1PHT-1584	E3CT1SST-1584	84"	E3CT1ERT-2784	E3CT1PHT-2784	E3CT1SST-2784	84"
E3CT1ERT-1596	E3CT1PHT-1596	E3CT1SST-1596	96"	E3CT1ERT-2796	E3CT1PHT-2796	E3CT1SST-2796	96"
18" Deep Top				30" Deep Top			
E3CT1ERT-1842	E3CT1PHT-1842	E3CT1SST-1842	42"	E3CT1ERT-3042	E3CT1PHT-3042	E3CT1SST-3042	42"
E3CT1ERT-1848	E3CT1PHT-1848	E3CT1SST-1848	48"	E3CT1ERT-3048	E3CT1PHT-3048	E3CT1SST-3048	48"
E3CT1ERT-1860	E3CT1PHT-1860	E3CT1SST-1860	60"	E3CT1ERT-3060	E3CT1PHT-3060	E3CT1SST-3060	60"
E3CT1ERT-1872	E3CT1PHT-1872	E3CT1SST-1872	72"	E3CT1ERT-3072	E3CT1PHT-3072	E3CT1SST-3072	72"
E3CT1ERT-1884	E3CT1PHT-1884	E3CT1SST-1884	84"	E3CT1ERT-3084	E3CT1PHT-3084	E3CT1SST-3084	84"
E3CT1ERT-1896	E3CT1PHT-1896	E3CT1SST-1896	96"	E3CT1ERT-3096	E3CT1PHT-3096	E3CT1SST-3096	96"
19" Deep Top				33" Deep Top			
E3CT1ERT-1942	E3CT1PHT-1942	E3CT1SST-1942	42"	E3CT1ERT-3342	E3CT1PHT-3342	E3CT1SST-3342	42"
E3CT1ERT-1948	E3CT1PHT-1948	E3CT1SST-1948	48"	E3CT1ERT-3348	E3CT1PHT-3348	E3CT1SST-3348	48"
E3CT1ERT-1960	E3CT1PHT-1960	E3CT1SST-1960	60"	E3CT1ERT-3360	E3CT1PHT-3360	E3CT1SST-3360	60"
E3CT1ERT-1972	E3CT1PHT-1972	E3CT1SST-1972	72"	E3CT1ERT-3372	E3CT1PHT-3372	E3CT1SST-3372	72"
E3CT1ERT-1984	E3CT1PHT-1984	E3CT1SST-1984	84"	E3CT1ERT-3384	E3CT1PHT-3384	E3CT1SST-3384	84"
E3CT1ERT-1996	E3CT1PHT-1996	E3CT1SST-1996	96"	E3CT1ERT-3396	E3CT1PHT-3396	E3CT1SST-3396	96"
21" Deep Top				36" Deep Top			
E3CT1ERT-2142	E3CT1PHT-2142	E3CT1SST-2142	42"	E3CT1ERT-3642	E3CT1PHT-3642	E3CT1SST-3642	42"
E3CT1ERT-2148	E3CT1PHT-2148	E3CT1SST-2148	48"	E3CT1ERT-3648	E3CT1PHT-3648	E3CT1SST-3648	48"
E3CT1ERT-2160	E3CT1PHT-2160	E3CT1SST-2160	60"	E3CT1ERT-3660	E3CT1PHT-3660	E3CT1SST-3660	60"
E3CT1ERT-2172	E3CT1PHT-2172	E3CT1SST-2172	72"	E3CT1ERT-3672	E3CT1PHT-3672	E3CT1SST-3672	72"
E3CT1ERT-2184	E3CT1PHT-2184	E3CT1SST-2184	84"	E3CT1ERT-3684	E3CT1PHT-3684	E3CT1SST-3684	84"
E3CT1ERT-2196	E3CT1PHT-2196	E3CT1SST-2196	96"	E3CT1ERT-3696	E3CT1PHT-3696	E3CT1SST-3696	96"
24" Deep Top							
E3CT1ERT-2442	E3CT1PHT-2442	E3CT1SST-2442	42"				
E3CT1ERT-2448	E3CT1PHT-2448	E3CT1SST-2448	48"				
E3CT1ERT-2460	E3CT1PHT-2460	E3CT1SST-2460	60"				
E3CT1ERT-2472	E3CT1PHT-2472	E3CT1SST-2472	72"				
E3CT1ERT-2484	E3CT1PHT-2484	E3CT1SST-2484	84"				
E3CT1ERT-2496	E3CT1PHT-2496	E3CT1SST-2496	96"				

Envision 3.0 - .75" Thick Shelving - No Rear Rod Cutout

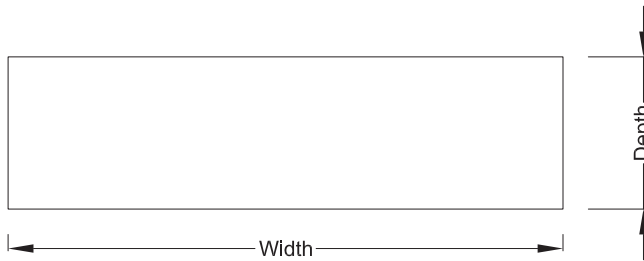

- These shelves to be used with Envision 3.0 brackets
- Each part number includes (1) shelf. If purchasing shelves for 60" uprights or wider you must order (2) shelves

Epoxy	Cat. No. Phenolic	Painted Steel	Stainless Steel	Wood - Maple	Wood - Oak	Actual Width	For Use With:
9.5" Deep							
E3S75ER-9542	E3S75PH-9542	E3S75MS-9542	E3S75SS-9542	E3S75WM-9542	E3S75WO-9542	37.75"	42" Wide Upright
E3S75ER-9548	E3S75PH-9548	E3S75MS-9548	E3S75SS-9548	E3S75WM-9548	E3S75WO-9548	43.75"	48" Wide Upright
E3S75ER-9560	E3S75PH-9560	E3S75MS-9560	E3S75SS-9560	E3S75WM-9560	E3S75WO-9560	26.75"	60" Wide Upright
E3S75ER-9572	E3S75PH-9572	E3S75MS-9572	E3S75SS-9572	E3S75WM-9572	E3S75WO-9572	32.75"	72" Wide Upright
E3S75ER-9584	E3S75PH-9584	E3S75MS-9584	E3S75SS-9584	E3S75WM-9584	E3S75WO-9584	38.75"	84" Wide Upright
E3S75ER-9596	E3S75PH-9596	E3S75MS-9596	E3S75SS-9596	E3S75WM-9596	E3S75WO-9596	44.75"	96" Wide Upright
12" Deep							
E3S75ER-1242	E3S75PH-1242	E3S75MS-1242	E3S75SS-1242	E3S75WM-1242	E3S75WO-1242	37.75"	42" Wide Upright
E3S75ER-1248	E3S75PH-1248	E3S75MS-1248	E3S75SS-1248	E3S75WM-1248	E3S75WO-1248	43.75"	48" Wide Upright
E3S75ER-1260	E3S75PH-1260	E3S75MS-1260	E3S75SS-1260	E3S75WM-1260	E3S75WO-1260	26.75"	60" Wide Upright
E3S75ER-1272	E3S75PH-1272	E3S75MS-1272	E3S75SS-1272	E3S75WM-1272	E3S75WO-1272	32.75"	72" Wide Upright
E3S75ER-1284	E3S75PH-1284	E3S75MS-1284	E3S75SS-1284	E3S75WM-1284	E3S75WO-1284	38.75"	84" Wide Upright
E3S75ER-1296	E3S75PH-1296	E3S75MS-1296	E3S75SS-1296	E3S75WM-1296	E3S75WO-1296	44.75"	96" Wide Upright
13" Deep							
E3S75ER-1342	E3S75PH-1342	E3S75MS-1342	E3S75SS-1342	E3S75WM-1342	E3S75WO-1342	37.75"	42" Wide Upright
E3S75ER-1348	E3S75PH-1348	E3S75MS-1348	E3S75SS-1348	E3S75WM-1348	E3S75WO-1348	43.75"	48" Wide Upright
E3S75ER-1360	E3S75PH-1360	E3S75MS-1360	E3S75SS-1360	E3S75WM-1360	E3S75WO-1360	26.75"	60" Wide Upright
E3S75ER-1372	E3S75PH-1372	E3S75MS-1372	E3S75SS-1372	E3S75WM-1372	E3S75WO-1372	32.75"	72" Wide Upright
E3S75ER-1384	E3S75PH-1384	E3S75MS-1384	E3S75SS-1384	E3S75WM-1384	E3S75WO-1384	38.75"	84" Wide Upright
E3S75ER-1396	E3S75PH-1396	E3S75MS-1396	E3S75SS-1396	E3S75WM-1396	E3S75WO-1396	44.75"	96" Wide Upright
15" Deep							
E3S75ER-1542	E3S75PH-1542	E3S75MS-1542	E3S75SS-1542	E3S75WM-1542	E3S75WO-1542	37.75"	42" Wide Upright
E3S75ER-1548	E3S75PH-1548	E3S75MS-1548	E3S75SS-1548	E3S75WM-1548	E3S75WO-1548	43.75"	48" Wide Upright
E3S75ER-1560	E3S75PH-1560	E3S75MS-1560	E3S75SS-1560	E3S75WM-1560	E3S75WO-1560	26.75"	60" Wide Upright
E3S75ER-1572	E3S75PH-1572	E3S75MS-1572	E3S75SS-1572	E3S75WM-1572	E3S75WO-1572	32.75"	72" Wide Upright
E3S75ER-1584	E3S75PH-1584	E3S75MS-1584	E3S75SS-1584	E3S75WM-1584	E3S75WO-1584	38.75"	84" Wide Upright
E3S75ER-1596	E3S75PH-1596	E3S75MS-1596	E3S75SS-1596	E3S75WM-1596	E3S75WO-1596	44.75"	96" Wide Upright
16" Deep							
E3S75ER-1642	E3S75PH-1642	E3S75MS-1642	E3S75SS-1642	E3S75WM-1642	E3S75WO-1642	37.75"	42" Wide Upright
E3S75ER-1648	E3S75PH-1648	E3S75MS-1648	E3S75SS-1648	E3S75WM-1648	E3S75WO-1648	43.75"	48" Wide Upright
E3S75ER-1660	E3S75PH-1660	E3S75MS-1660	E3S75SS-1660	E3S75WM-1660	E3S75WO-1660	26.75"	60" Wide Upright
E3S75ER-1672	E3S75PH-1672	E3S75MS-1672	E3S75SS-1672	E3S75WM-1672	E3S75WO-1672	32.75"	72" Wide Upright
E3S75ER-1684	E3S75PH-1684	E3S75MS-1684	E3S75SS-1684	E3S75WM-1684	E3S75WO-1684	38.75"	84" Wide Upright
E3S75ER-1696	E3S75PH-1696	E3S75MS-1696	E3S75SS-1696	E3S75WM-1696	E3S75WO-1696	44.75"	96" Wide Upright
18" Deep							
E3S75ER-1842	E3S75PH-1842	E3S75MS-1842	E3S75SS-1842	E3S75WM-1842	E3S75WO-1842	37.75"	42" Wide Upright
E3S75ER-1848	E3S75PH-1848	E3S75MS-1848	E3S75SS-1848	E3S75WM-1848	E3S75WO-1848	43.75"	48" Wide Upright
E3S75ER-1860	E3S75PH-1860	E3S75MS-1860	E3S75SS-1860	E3S75WM-1860	E3S75WO-1860	26.75"	60" Wide Upright
E3S75ER-1872	E3S75PH-1872	E3S75MS-1872	E3S75SS-1872	E3S75WM-1872	E3S75WO-1872	32.75"	72" Wide Upright
E3S75ER-1884	E3S75PH-1884	E3S75MS-1884	E3S75SS-1884	E3S75WM-1884	E3S75WO-1884	38.75"	84" Wide Upright
E3S75ER-1896	E3S75PH-1896	E3S75MS-1896	E3S75SS-1896	E3S75WM-1896	E3S75WO-1896	44.75"	96" Wide Upright

Envision 3.0

Envision 3.0 - 1" Thick Shelving - No Rear Rod Cutout

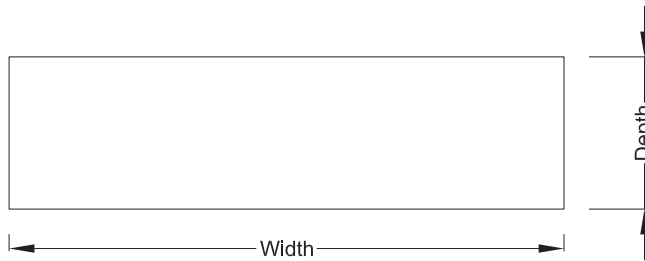

- These shelves to be used with Envision 3.0 brackets
- Each part number includes (1) shelf. If purchasing shelves for 60" uprights or wider you must order (2) shelves

Epoxy	Cat. No.		Painted Steel	Stainless Steel	Wood - Maple	Wood - Oak	Actual Width	For Use With:
	Phenolic							
9.5" Deep								
E3S1ER-9542	E3S1PH-9542	E3S1MS-9542	E3S1SS-9542	E3S1WM-9542	E3S1WO-9542	37.75"	42" Wide Upright	
E3S1ER-9548	E3S1PH-9548	E3S1MS-9548	E3S1SS-9548	E3S1WM-9548	E3S1WO-9548	43.75"	48" Wide Upright	
E3S1ER-9560	E3S1PH-9560	E3S1MS-9560	E3S1SS-9560	E3S1WM-9560	E3S1WO-9560	26.75"	60" Wide Upright	
E3S1ER-9572	E3S1PH-9572	E3S1MS-9572	E3S1SS-9572	E3S1WM-9572	E3S1WO-9572	32.75"	72" Wide Upright	
E3S1ER-9584	E3S1PH-9584	E3S1MS-9584	E3S1SS-9584	E3S1WM-9584	E3S1WO-9584	38.75"	84" Wide Upright	
E3S1ER-9596	E3S1PH-9596	E3S1MS-9596	E3S1SS-9596	E3S1WM-9596	E3S1WO-9596	44.75"	96" Wide Upright	
12" Deep								
E3S1ER-1242	E3S1PH-1242	E3S1MS-1242	E3S1SS-1242	E3S1WM-1242	E3S1WO-1242	37.75"	42" Wide Upright	
E3S1ER-1248	E3S1PH-1248	E3S1MS-1248	E3S1SS-1248	E3S1WM-1248	E3S1WO-1248	43.75"	48" Wide Upright	
E3S1ER-1260	E3S1PH-1260	E3S1MS-1260	E3S1SS-1260	E3S1WM-1260	E3S1WO-1260	26.75"	60" Wide Upright	
E3S1ER-1272	E3S1PH-1272	E3S1MS-1272	E3S1SS-1272	E3S1WM-1272	E3S1WO-1272	32.75"	72" Wide Upright	
E3S1ER-1284	E3S1PH-1284	E3S1MS-1284	E3S1SS-1284	E3S1WM-1284	E3S1WO-1284	38.75"	84" Wide Upright	
E3S1ER-1296	E3S1PH-1296	E3S1MS-1296	E3S1SS-1296	E3S1WM-1296	E3S1WO-1296	44.75"	96" Wide Upright	
13" Deep								
E3S1ER-1342	E3S1PH-1342	E3S1MS-1342	E3S1SS-1342	E3S1WM-1342	E3S1WO-1342	37.75"	42" Wide Upright	
E3S1ER-1348	E3S1PH-1348	E3S1MS-1348	E3S1SS-1348	E3S1WM-1348	E3S1WO-1348	43.75"	48" Wide Upright	
E3S1ER-1360	E3S1PH-1360	E3S1MS-1360	E3S1SS-1360	E3S1WM-1360	E3S1WO-1360	26.75"	60" Wide Upright	
E3S1ER-1372	E3S1PH-1372	E3S1MS-1372	E3S1SS-1372	E3S1WM-1372	E3S1WO-1372	32.75"	72" Wide Upright	
E3S1ER-1384	E3S1PH-1384	E3S1MS-1384	E3S1SS-1384	E3S1WM-1384	E3S1WO-1384	38.75"	84" Wide Upright	
E3S1ER-1396	E3S1PH-1396	E3S1MS-1396	E3S1SS-1396	E3S1WM-1396	E3S1WO-1396	44.75"	96" Wide Upright	
15" Deep								
E3S1ER-1542	E3S1PH-1542	E3S1MS-1542	E3S1SS-1542	E3S1WM-1542	E3S1WO-1542	37.75"	42" Wide Upright	
E3S1ER-1548	E3S1PH-1548	E3S1MS-1548	E3S1SS-1548	E3S1WM-1548	E3S1WO-1548	43.75"	48" Wide Upright	
E3S1ER-1560	E3S1PH-1560	E3S1MS-1560	E3S1SS-1560	E3S1WM-1560	E3S1WO-1560	26.75"	60" Wide Upright	
E3S1ER-1572	E3S1PH-1572	E3S1MS-1572	E3S1SS-1572	E3S1WM-1572	E3S1WO-1572	32.75"	72" Wide Upright	
E3S1ER-1584	E3S1PH-1584	E3S1MS-1584	E3S1SS-1584	E3S1WM-1584	E3S1WO-1584	38.75"	84" Wide Upright	
E3S1ER-1596	E3S1PH-1596	E3S1MS-1596	E3S1SS-1596	E3S1WM-1596	E3S1WO-1596	44.75"	96" Wide Upright	
16" Deep								
E3S1ER-1642	E3S1PH-1642	E3S1MS-1642	E3S1SS-1642	E3S1WM-1642	E3S1WO-1642	37.75"	42" Wide Upright	
E3S1ER-1648	E3S1PH-1648	E3S1MS-1648	E3S1SS-1648	E3S1WM-1648	E3S1WO-1648	43.75"	48" Wide Upright	
E3S1ER-1660	E3S1PH-1660	E3S1MS-1660	E3S1SS-1660	E3S1WM-1660	E3S1WO-1660	26.75"	60" Wide Upright	
E3S1ER-1672	E3S1PH-1672	E3S1MS-1672	E3S1SS-1672	E3S1WM-1672	E3S1WO-1672	32.75"	72" Wide Upright	
E3S1ER-1684	E3S1PH-1684	E3S1MS-1684	E3S1SS-1684	E3S1WM-1684	E3S1WO-1684	38.75"	84" Wide Upright	
E3S1ER-1696	E3S1PH-1696	E3S1MS-1696	E3S1SS-1696	E3S1WM-1696	E3S1WO-1696	44.75"	96" Wide Upright	
18" Deep								
E3S1ER-1842	E3S1PH-1842	E3S1MS-1842	E3S1SS-1842	E3S1WM-1842	E3S1WO-1842	37.75"	42" Wide Upright	
E3S1ER-1848	E3S1PH-1848	E3S1MS-1848	E3S1SS-1848	E3S1WM-1848	E3S1WO-1848	43.75"	48" Wide Upright	
E3S1ER-1860	E3S1PH-1860	E3S1MS-1860	E3S1SS-1860	E3S1WM-1860	E3S1WO-1860	26.75"	60" Wide Upright	
E3S1ER-1872	E3S1PH-1872	E3S1MS-1872	E3S1SS-1872	E3S1WM-1872	E3S1WO-1872	32.75"	72" Wide Upright	
E3S1ER-1884	E3S1PH-1884	E3S1MS-1884	E3S1SS-1884	E3S1WM-1884	E3S1WO-1884	38.75"	84" Wide Upright	
E3S1ER-1896	E3S1PH-1896	E3S1MS-1896	E3S1SS-1896	E3S1WM-1896	E3S1WO-1896	44.75"	96" Wide Upright	

Envision 3.0 - .75" Thick Shelving with Cutouts for Rear Rod

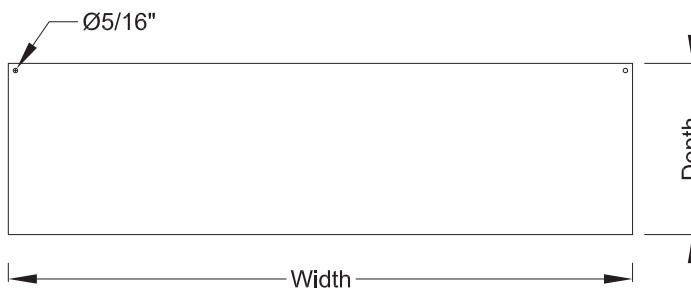

- These shelves to be used with Envision 3.0 brackets
- Each part number includes (1) shelf. If purchasing shelves for 60" uprights or wider you must order (2) shelves
- These shelves include cutouts for rear rod

Epoxy	Cat. No.		Stainless Steel	Wood - Maple	Wood - Oak	Actual Width	For Use With:
	Phenolic	Painted Steel					
9.5" Deep							
E3S75ERR-9542	E3S75PHR-9542	E3S75MSR-9542	E3S75SSR-9542	E3S75WMR-9542	E3S75WOR-9542	37.75"	42" Wide Upright
E3S75ERR-9548	E3S75PHR-9548	E3S75MSR-9548	E3S75SSR-9548	E3S75WMR-9548	E3S75WOR-9548	43.75"	48" Wide Upright
E3S75ERR-9560	E3S75PHR-9560	E3S75MSR-9560	E3S75SSR-9560	E3S75WMR-9560	E3S75WOR-9560	26.75"	60" Wide Upright
E3S75ERR-9572	E3S75PHR-9572	E3S75MSR-9572	E3S75SSR-9572	E3S75WMR-9572	E3S75WOR-9572	32.75"	72" Wide Upright
E3S75ERR-9584	E3S75PHR-9584	E3S75MSR-9584	E3S75SSR-9584	E3S75WMR-9584	E3S75WOR-9584	38.75"	84" Wide Upright
E3S75ERR-9596	E3S75PHR-9596	E3S75MSR-9596	E3S75SSR-9596	E3S75WMR-9596	E3S75WOR-9596	44.75"	96" Wide Upright
12" Deep							
E3S75ERR-1242	E3S75PHR-1242	E3S75MSR-1242	E3S75SSR-1242	E3S75WMR-1242	E3S75WOR-1242	37.75"	42" Wide Upright
E3S75ERR-1248	E3S75PHR-1248	E3S75MSR-1248	E3S75SSR-1248	E3S75WMR-1248	E3S75WOR-1248	43.75"	48" Wide Upright
E3S75ERR-1260	E3S75PHR-1260	E3S75MSR-1260	E3S75SSR-1260	E3S75WMR-1260	E3S75WOR-1260	26.75"	60" Wide Upright
E3S75ERR-1272	E3S75PHR-1272	E3S75MSR-1272	E3S75SSR-1272	E3S75WMR-1272	E3S75WOR-1272	32.75"	72" Wide Upright
E3S75ERR-1284	E3S75PHR-1284	E3S75MSR-1284	E3S75SSR-1284	E3S75WMR-1284	E3S75WOR-1284	38.75"	84" Wide Upright
E3S75ERR-1296	E3S75PHR-1296	E3S75MSR-1296	E3S75SSR-1296	E3S75WMR-1296	E3S75WOR-1296	44.75"	96" Wide Upright
13" Deep							
E3S75ERR-1342	E3S75PHR-1342	E3S75MSR-1342	E3S75SSR-1342	E3S75WMR-1342	E3S75WOR-1342	37.75"	42" Wide Upright
E3S75ERR-1348	E3S75PHR-1348	E3S75MSR-1348	E3S75SSR-1348	E3S75WMR-1348	E3S75WOR-1348	43.75"	48" Wide Upright
E3S75ERR-1360	E3S75PHR-1360	E3S75MSR-1360	E3S75SSR-1360	E3S75WMR-1360	E3S75WOR-1360	26.75"	60" Wide Upright
E3S75ERR-1372	E3S75PHR-1372	E3S75MSR-1372	E3S75SSR-1372	E3S75WMR-1372	E3S75WOR-1372	32.75"	72" Wide Upright
E3S75ERR-1384	E3S75PHR-1384	E3S75MSR-1384	E3S75SSR-1384	E3S75WMR-1384	E3S75WOR-1384	38.75"	84" Wide Upright
E3S75ERR-1396	E3S75PHR-1396	E3S75MSR-1396	E3S75SSR-1396	E3S75WMR-1396	E3S75WOR-1396	44.75"	96" Wide Upright
15" Deep							
E3S75ERR-1542	E3S75PHR-1542	E3S75MSR-1542	E3S75SSR-1542	E3S75WMR-1542	E3S75WOR-1542	37.75"	42" Wide Upright
E3S75ERR-1548	E3S75PHR-1548	E3S75MSR-1548	E3S75SSR-1548	E3S75WMR-1548	E3S75WOR-1548	43.75"	48" Wide Upright
E3S75ERR-1560	E3S75PHR-1560	E3S75MSR-1560	E3S75SSR-1560	E3S75WMR-1560	E3S75WOR-1560	26.75"	60" Wide Upright
E3S75ERR-1572	E3S75PHR-1572	E3S75MSR-1572	E3S75SSR-1572	E3S75WMR-1572	E3S75WOR-1572	32.75"	72" Wide Upright
E3S75ERR-1584	E3S75PHR-1584	E3S75MSR-1584	E3S75SSR-1584	E3S75WMR-1584	E3S75WOR-1584	38.75"	84" Wide Upright
E3S75ERR-1596	E3S75PHR-1596	E3S75MSR-1596	E3S75SSR-1596	E3S75WMR-1596	E3S75WOR-1596	44.75"	96" Wide Upright
16" Deep							
E3S75ERR-1642	E3S75PHR-1642	E3S75MSR-1642	E3S75SSR-1642	E3S75WMR-1642	E3S75WOR-1642	37.75"	42" Wide Upright
E3S75ERR-1648	E3S75PHR-1648	E3S75MSR-1648	E3S75SSR-1648	E3S75WMR-1648	E3S75WOR-1648	43.75"	48" Wide Upright
E3S75ERR-1660	E3S75PHR-1660	E3S75MSR-1660	E3S75SSR-1660	E3S75WMR-1660	E3S75WOR-1660	26.75"	60" Wide Upright
E3S75ERR-1672	E3S75PHR-1672	E3S75MSR-1672	E3S75SSR-1672	E3S75WMR-1672	E3S75WOR-1672	32.75"	72" Wide Upright
E3S75ERR-1684	E3S75PHR-1684	E3S75MSR-1684	E3S75SSR-1684	E3S75WMR-1684	E3S75WOR-1684	38.75"	84" Wide Upright
E3S75ERR-1696	E3S75PHR-1696	E3S75MSR-1696	E3S75SSR-1696	E3S75WMR-1696	E3S75WOR-1696	44.75"	96" Wide Upright
18" Deep							
E3S75ERR-1842	E3S75PHR-1842	E3S75MSR-1842	E3S75SSR-1842	E3S75WMR-1842	E3S75WOR-1842	37.75"	42" Wide Upright
E3S75ERR-1848	E3S75PHR-1848	E3S75MSR-1848	E3S75SSR-1848	E3S75WMR-1848	E3S75WOR-1848	43.75"	48" Wide Upright
E3S75ERR-1860	E3S75PHR-1860	E3S75MSR-1860	E3S75SSR-1860	E3S75WMR-1860	E3S75WOR-1860	26.75"	60" Wide Upright
E3S75ERR-1872	E3S75PHR-1872	E3S75MSR-1872	E3S75SSR-1872	E3S75WMR-1872	E3S75WOR-1872	32.75"	72" Wide Upright
E3S75ERR-1884	E3S75PHR-1884	E3S75MSR-1884	E3S75SSR-1884	E3S75WMR-1884	E3S75WOR-1884	38.75"	84" Wide Upright
E3S75ERR-1896	E3S75PHR-1896	E3S75MSR-1896	E3S75SSR-1896	E3S75WMR-1896	E3S75WOR-1896	44.75"	96" Wide Upright

Envision 3.0

Envision 3.0 - 1" Thick Shelving with Cutouts for Rear Rod

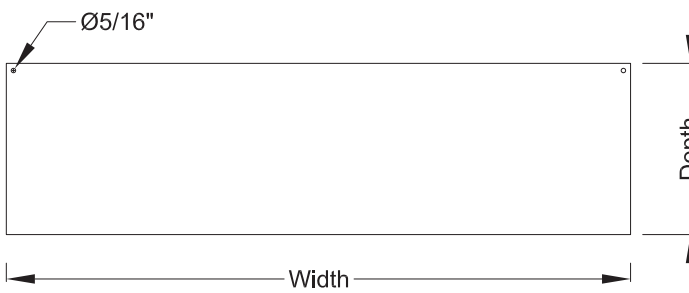

- These shelves to be used with Envision 3.0 brackets
- Each part number includes (1) shelf. If purchasing shelves for 60" uprights or wider you must order (2) shelves
- These shelves include cutouts for rear rod

Epoxy	Cat. No.		Painted Steel	Stainless Steel	Wood - Maple	Wood - Oak	Actual Width	For Use With:
	Phenolic							
9.5" Deep								
E3S1ERR-9542	E3S1PHR-9542	E3S1MSR-9542	E3S1SSR-9542	E3S1WMR-9542	E3S1WOR-9542	37.75"	42" Wide Upright	
E3S1ERR-9548	E3S1PHR-9548	E3S1MSR-9548	E3S1SSR-9548	E3S1WMR-9548	E3S1WOR-9548	43.75"	48" Wide Upright	
E3S1ERR-9560	E3S1PHR-9560	E3S1MSR-9560	E3S1SSR-9560	E3S1WMR-9560	E3S1WOR-9560	26.75"	60" Wide Upright	
E3S1ERR-9572	E3S1PHR-9572	E3S1MSR-9572	E3S1SSR-9572	E3S1WMR-9572	E3S1WOR-9572	32.75"	72" Wide Upright	
E3S1ERR-9584	E3S1PHR-9584	E3S1MSR-9584	E3S1SSR-9584	E3S1WMR-9584	E3S1WOR-9584	38.75"	84" Wide Upright	
E3S1ERR-9596	E3S1PHR-9596	E3S1MSR-9596	E3S1SSR-9596	E3S1WMR-9596	E3S1WOR-9596	44.75"	96" Wide Upright	
12" Deep								
E3S1ERR-1242	E3S1PHR-1242	E3S1MSR-1242	E3S1SSR-1242	E3S1WMR-1242	E3S1WOR-1242	37.75"	42" Wide Upright	
E3S1ERR-1248	E3S1PHR-1248	E3S1MSR-1248	E3S1SSR-1248	E3S1WMR-1248	E3S1WOR-1248	43.75"	48" Wide Upright	
E3S1ERR-1260	E3S1PHR-1260	E3S1MSR-1260	E3S1SSR-1260	E3S1WMR-1260	E3S1WOR-1260	26.75"	60" Wide Upright	
E3S1ERR-1272	E3S1PHR-1272	E3S1MSR-1272	E3S1SSR-1272	E3S1WMR-1272	E3S1WOR-1272	32.75"	72" Wide Upright	
E3S1ERR-1284	E3S1PHR-1284	E3S1MSR-1284	E3S1SSR-1284	E3S1WMR-1284	E3S1WOR-1284	38.75"	84" Wide Upright	
E3S1ERR-1296	E3S1PHR-1296	E3S1MSR-1296	E3S1SSR-1296	E3S1WMR-1296	E3S1WOR-1296	44.75"	96" Wide Upright	
13" Deep								
E3S1ERR-1342	E3S1PHR-1342	E3S1MSR-1342	E3S1SSR-1342	E3S1WMR-1342	E3S1WOR-1342	37.75"	42" Wide Upright	
E3S1ERR-1348	E3S1PHR-1348	E3S1MSR-1348	E3S1SSR-1348	E3S1WMR-1348	E3S1WOR-1348	43.75"	48" Wide Upright	
E3S1ERR-1360	E3S1PHR-1360	E3S1MSR-1360	E3S1SSR-1360	E3S1WMR-1360	E3S1WOR-1360	26.75"	60" Wide Upright	
E3S1ERR-1372	E3S1PHR-1372	E3S1MSR-1372	E3S1SSR-1372	E3S1WMR-1372	E3S1WOR-1372	32.75"	72" Wide Upright	
E3S1ERR-1384	E3S1PHR-1384	E3S1MSR-1384	E3S1SSR-1384	E3S1WMR-1384	E3S1WOR-1384	38.75"	84" Wide Upright	
E3S1ERR-1396	E3S1PHR-1396	E3S1MSR-1396	E3S1SSR-1396	E3S1WMR-1396	E3S1WOR-1396	44.75"	96" Wide Upright	
15" Deep								
E3S1ERR-1542	E3S1PHR-1542	E3S1MSR-1542	E3S1SSR-1542	E3S1WMR-1542	E3S1WOR-1542	37.75"	42" Wide Upright	
E3S1ERR-1548	E3S1PHR-1548	E3S1MSR-1548	E3S1SSR-1548	E3S1WMR-1548	E3S1WOR-1548	43.75"	48" Wide Upright	
E3S1ERR-1560	E3S1PHR-1560	E3S1MSR-1560	E3S1SSR-1560	E3S1WMR-1560	E3S1WOR-1560	26.75"	60" Wide Upright	
E3S1ERR-1572	E3S1PHR-1572	E3S1MSR-1572	E3S1SSR-1572	E3S1WMR-1572	E3S1WOR-1572	32.75"	72" Wide Upright	
E3S1ERR-1584	E3S1PHR-1584	E3S1MSR-1584	E3S1SSR-1584	E3S1WMR-1584	E3S1WOR-1584	38.75"	84" Wide Upright	
E3S1ERR-1596	E3S1PHR-1596	E3S1MSR-1596	E3S1SSR-1596	E3S1WMR-1596	E3S1WOR-1596	44.75"	96" Wide Upright	
16" Deep								
E3S1ERR-1642	E3S1PHR-1642	E3S1MSR-1642	E3S1SSR-1642	E3S1WMR-1642	E3S1WOR-1642	37.75"	42" Wide Upright	
E3S1ERR-1648	E3S1PHR-1648	E3S1MSR-1648	E3S1SSR-1648	E3S1WMR-1648	E3S1WOR-1648	43.75"	48" Wide Upright	
E3S1ERR-1660	E3S1PHR-1660	E3S1MSR-1660	E3S1SSR-1660	E3S1WMR-1660	E3S1WOR-1660	26.75"	60" Wide Upright	
E3S1ERR-1672	E3S1PHR-1672	E3S1MSR-1672	E3S1SSR-1672	E3S1WMR-1672	E3S1WOR-1672	32.75"	72" Wide Upright	
E3S1ERR-1684	E3S1PHR-1684	E3S1MSR-1684	E3S1SSR-1684	E3S1WMR-1684	E3S1WOR-1684	38.75"	84" Wide Upright	
E3S1ERR-1696	E3S1PHR-1696	E3S1MSR-1696	E3S1SSR-1696	E3S1WMR-1696	E3S1WOR-1696	44.75"	96" Wide Upright	
18" Deep								
E3S1ERR-1842	E3S1PHR-1842	E3S1MSR-1842	E3S1SSR-1842	E3S1WMR-1842	E3S1WOR-1842	37.75"	42" Wide Upright	
E3S1ERR-1848	E3S1PHR-1848	E3S1MSR-1848	E3S1SSR-1848	E3S1WMR-1848	E3S1WOR-1848	43.75"	48" Wide Upright	
E3S1ERR-1860	E3S1PHR-1860	E3S1MSR-1860	E3S1SSR-1860	E3S1WMR-1860	E3S1WOR-1860	26.75"	60" Wide Upright	
E3S1ERR-1872	E3S1PHR-1872	E3S1MSR-1872	E3S1SSR-1872	E3S1WMR-1872	E3S1WOR-1872	32.75"	72" Wide Upright	
E3S1ERR-1884	E3S1PHR-1884	E3S1MSR-1884	E3S1SSR-1884	E3S1WMR-1884	E3S1WOR-1884	38.75"	84" Wide Upright	
E3S1ERR-1896	E3S1PHR-1896	E3S1MSR-1896	E3S1SSR-1896	E3S1WMR-1896	E3S1WOR-1896	44.75"	96" Wide Upright	

Envision 3.0 - Bookend Brackets

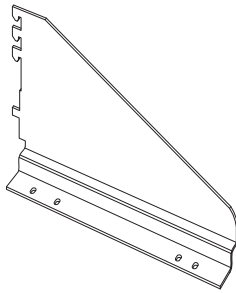

- These brackets to be used with Envision 3.0 uprights
- Sold in pairs

Cat. No.		Depth
Painted Steel	Stainless Steel	
.75" Thick Shelf		
E3SBB75-9	E3SBB75-9S	9"
E3SBB75-12	E3SBB75-12S	12"
E3SBB75-15	E3SBB75-15S	15"
1" Thick Shelf		
E3SBB1-9	E3SBB1-9S	9"
E3SBB1-12	E3SBB1-12S	12"
E3SBB1-15	E3SBB1-15S	15"

Envision 3.0 - Inverted Brackets

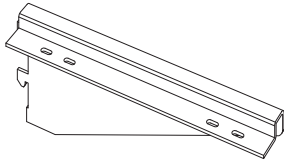

- These brackets to be used with Envision 3.0 uprights
- Sold in pairs

Cat. No.		Depth
Painted Steel	Stainless Steel	
.75" Thick Shelf		
E3SBI75-9	E3SBI75-9S	9"
E3SBI75-12	E3SBI75-12S	12"
E3SBI75-15	E3SBI75-15S	15"
1" Thick Shelf		
E3SBI1-9	E3SBI1-9S	9"
E3SBI1-12	E3SBI1-12S	12"
E3SBI1-15	E3SBI1-15S	15"

Envision 3.0 - Shelf Lip

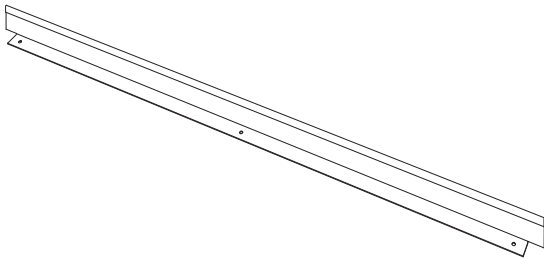

- These shelf lips to be used with Envision 3.0 shelves

Cat. No.		Width
Painted Steel	Stainless Steel	
Shelf Lip Front Mount		
E3SLF-42	E3SLF-42S	37.75"
E3SLF-48	E3SLF-48S	43.75"
E3SLF-60	E3SLF-60S	26.75"
E3SLF-72	E3SLF-72S	32.75"
E3SLF-84	E3SLF-84S	38.75"
E3SLF-96	E3SLF-96S	44.75"
Shelf Lip Rear Mount		
E3SLR-42	E3SLR-42S	37.75"
E3SLR-48	E3SLR-48S	43.75"
E3SLR-60	E3SLR-60S	26.75"
E3SLR-72	E3SLR-72S	32.75"
E3SLR-84	E3SLR-84S	38.75"
E3SLR-96	E3SLR-96S	44.75"

Envision 3.0

Envision 3.0 - Front Shelf Rod

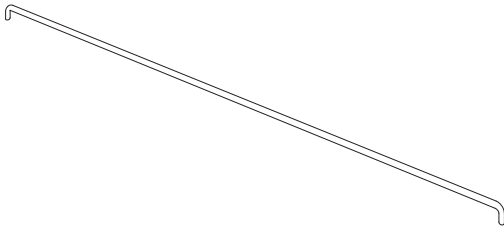

- These shelf rods to be used with Envision 3.0 shelves
- Each part number includes (1) front shelf rod. If purchasing shelf rods for 60" uprights or wider you must order (2) front shelf rods

Cat. No.		Width
Aluminum	Stainless Steel	
E3SRF-42	E3SRF-42S	38.875"
E3SRF-48	E3SRF-48S	44.875"
E3SRF-60	E3SRF-60S	27.875"
E3SRF-72	E3SRF-72S	33.875"
E3SRF-84	E3SRF-84S	39.875"
E3SRF-96	E3SRF-96S	45.875"

Envision 3.0 - Rear Shelf Rod

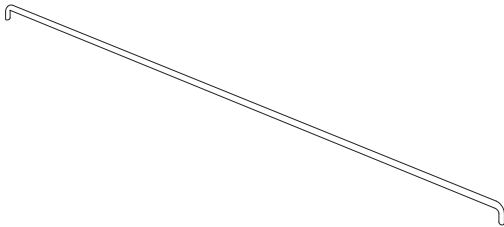

- These shelf rods to be used with Envision 3.0 shelves
- Each part number includes (1) rear shelf rod. If purchasing shelf rods for 60" uprights or wider you must order (2) rear shelf rods

Cat. No.		Width
Aluminum	Stainless Steel	
E3SRR-42	E3SRR-42S	36.75"
E3SRR-48	E3SRR-48S	42.75"
E3SRR-60	E3SRR-60S	25.75"
E3SRR-72	E3SRR-72S	31.75"
E3SRR-84	E3SRR-84S	37.75"
E3SRR-96	E3SRR-96S	43.75"

Envision 3.0 - Side Shelf Rod

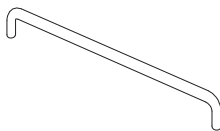

- These shelf rods to be used with Envision 3.0 shelves

Cat. No.		Depth
Aluminum	Stainless Steel	
E3SRS-9	E3SRS-9S	7"
E3SRS-12	E3SRS-12S	10"
E3SRS-15	E3SRS-15S	13"

Envision 3.0 - Wall Cabinet Hanger Bars

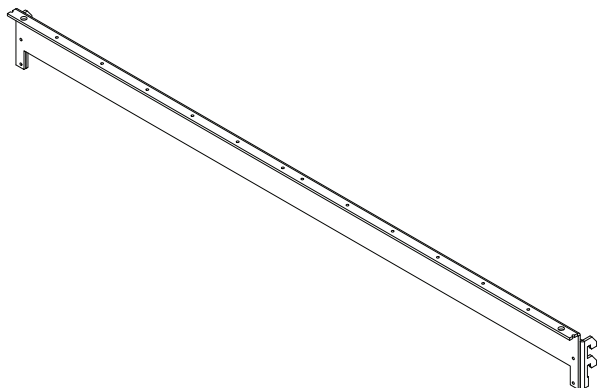

- These wall cabinet hangers to be used with Envision 3.0 uprights
- Each part number includes a pair of hanger bar. If purchasing hanger bars for 60" uprights or wider you must order (2) pairs of 00000hanger bars

Cat. No.		Actual Width	For use with:
Painted Steel	Stainless Steel		
E3PWCH-42	E3PWCH-42S	42"	42" wide uprights
E3PWCH-48	E3PWCH-48S	48"	48" wide uprights
E3PWCH-60	E3PWCH-60S	30"	60" wide uprights
E3PWCH-72	E3PWCH-72S	36"	72" wide uprights
E3PWCH-84	E3PWCH-84S	42"	84" wide uprights
E3PWCH-96	E3PWCH-96S	48"	96" wide uprights

Envision 3.0 - Cabinet Stop

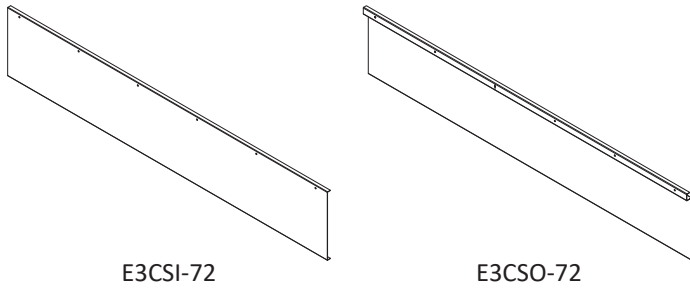

- These Cabinet Stops are to be used with Envision 3.0
- They are to prevent mobile cabinet from rolling to far under the work surface

Cat. No.		Actual Width	Width
For Inset Cabinet	For Overlay Cabinet		
E3CSI-42	E3CSO-42	34.75"	42"
E3CSI-48	E3CSO-48	40.75"	48"
E3CSI-60	E3CSO-60	52.75"	60"
E3CSI-72	E3CSO-72	64.75"	72"
E3CSI-84	E3CSO-84	76.75"	84"
E3CSI-96	E3CSO-96	88.75"	96"

Envision 3.0 - Stabilizer Bar

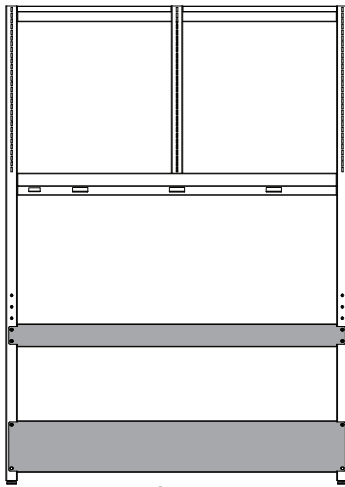

Elevation of Stabilizer Bars

- These Stabilizer Bars are to be used with Envision 3.0

Cat. No.		Width
Lower Brace	Upper Brace	
E3SBRL-42	E3SBRU-42	42"
E3SBRL-48	E3SBRU-48	48"
E3SBRL-60	E3SBRU-60	60"
E3SBRL-72	E3SBRU-72	72"
E3SBRL-84	E3SBRU-84	84"
E3SBRL-96	E3SBRU-96	96"

Envision 3.0 - Table Support Clamps



- These are to be used with Envision 3.0
- Kit of 2 with hardware
- Use for all tables on backside of 6" uprights

Cat. No.	Type
E3TSC	Table Support Clamps

Envision 3.0

Envision 3.0 - 3" Mounting Kits

- These are to be used with Envision 3.0
- Fasteners for connecting back to back 3" uprights

Cat. No.	Type
E3MKU3	Upright Connectors

LED Task Lighting for Envision 3.0



- Touch and hold continuous dimming and 10 hour automatic turnoff
- Units with (1) light include: (1) LED task light, magnetic angle mount that allows for up to 25° adjustment, 60 watt power supply with magnetic mount and 6' white cord
- Units with (2) lights include: (2) LED task light, magnetic angle mount that allows for up to 25° adjustment, 60 watt power supply with magnetic mount, 6' white cord, and 1 interlink cord to connect lights
- 60 watt power supply with magnetic mount and 6' white cord
- Made with anodized aluminum
- Lasts up to 50,000 hours

Cat. No.	Quantity of Lights	Actual Width	For use with:
Single Sided			
TL17-LED	1	17"	42" wide Table
TL17-LED	1	17"	48" wide Table
TL34-LED	2	17"	60" wide Table
TL34-LED	2	17"	72" wide Table
TL34-LED	2	17"	84" with Table
TL34-LED	2	17"	96" wide Table
Double Sided			
TL17-LEDDBL	2	17"	42" wide Table
TL17-LEDDBL	2	17"	48" wide Table
TL34-LEDDBL	4	17"	60" wide Table
TL34-LEDDBL	4	17"	72" wide Table
TL34-LEDDBL	4	17"	84" with Table
TL34-LEDDBL	4	17"	96" wide Table

Add Leveling Casters to Envision Uprights

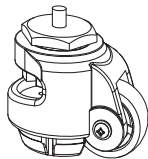

- (4) Leveling Caster has a disc style leveling function
- Weight capacity up to 1,000 lbs
- Can only be used with 3" uprights, Envision 3.0 or 4.0
- Casters add 3" to overall height of uprights
- Both Stabilizer Bars are recommended if using casters

Cat. No.	Type
E3HD-KIT	Add for Leveling Caster

Envision 3.0 Electrical for 3" upright

Sample: E3W3A $\frac{\quad}{1} \frac{\quad}{2} \frac{\quad}{3}$ - (width of upright)

Space 1 Options:

G = Grey
I = Ivory
W = White

Space 2 Options:

4 = 4' cord above upright
6 = 6' cord above upright

Space 3 Options:

(Blank) = Standard outlet
G = GFI outlet

Cat. No.	Description	Width Options
E3W3A ___ - ___	1 circuit, 1 plug, 3 electrical outlets	42", 48"
E3W3B ___ - ___	2 circuit, 1 plug, 3 electrical outlets	42", 48"
E3W3C ___ - ___	2 circuit, 2 plug, 3 electrical outlets	42", 48"
E3W3D ___ - ___	1 circuit, 1 plug, 4 electrical outlets	60", 72", 84", 96"
E3W3E ___ - ___	2 circuit, 1 plug, 4 electrical outlets	60", 72", 84", 96"
E3W3F ___ - ___	2 circuit, 2 plug, 4 electrical outlets	60", 72", 84", 96"
E3W3G ___ - ___	4 circuit, 2 plug, 4 electrical outlets	60", 72", 84", 96"

Example: E3W3AG4G-48

Envision 3.0 Wiring for 3" upright, Grey, 1 circuit, 1 plug, 3 GFI outlets, for 48" wide upright

Note: All electrical components are UL Labeled and pre-wiring is UL Listed

Envision 3.0 Electrical for 6" upright

Sample: E3W6A $\frac{\quad}{1} \frac{\quad}{2} \frac{\quad}{3}$ - (width of upright)

Space 1 Options:

G = Grey
I = Ivory
W = White

Space 2 Options:

4 = 4' cord above upright
6 = 6' cord above upright

Space 3 Options:

(Blank) = Standard outlet
G - GFI outlet

Cat. No.	Description	Width Options
E3W6A ___ - ___	1 circuit, 1 plug, 6 electrical outlets	42", 48"
E3W6B ___ - ___	2 circuit, 1 plug, 6 electrical outlets	42", 48"
E3W6C ___ - ___	2 circuit, 2 plug, 6 electrical outlets	42", 48"
E3W6D ___ - ___	1 circuit, 1 plug, 8 electrical outlets	60", 72", 84", 96"
E3W6E ___ - ___	2 circuit, 1 plug, 8 electrical outlets	60", 72", 84", 96"
E3W6F ___ - ___	2 circuit, 2 plug, 8 electrical outlets	60", 72", 84", 96"
E3W6G ___ - ___	4 circuit, 2 plug, 8 electrical outlets	60", 72", 84", 96"

Example: E3W6AG4G-48

Envision 3.0 Wiring for 6" upright, Grey, 1 circuit, 1 plug, 6 GFI outlets, for 48" wide upright

Note: All electrical components are UL Labeled and pre-wiring is UL Listed

Envision 3.0 Data

Envision 3.0 Data for 3" upright

Sample: E3D31 $\frac{\quad}{1} \frac{\quad}{2}$ - (width of upright)

Space 1 Options:

G = Light Grey

Space 2 Options:

4 = 4' cord above upright

6 = 6' cord above upright

Cat. No.	Description	Width Options
E3D31 ___ - ___	Single Data Outlet	42", 48", 60", 72", 84", 96"
E3D32 ___ - ___	Double Data Outlet	42", 48", 60", 72", 84", 96"

Example: E3D31G4-48

Envision 3.0 Data for 3" upright, Light Grey, Single Data Outlet, for 48" wide upright

Note: Data is CAT-5E. If other data is required contact your ICI representative.

Envision 3.0 Data for 6" upright

Sample: E3D61 $\frac{\quad}{1} \frac{\quad}{2}$ - (width of upright)

Space 1 Options:

G = Light Grey

Space 2 Options:

4 = 4' cord above upright

6 = 6' cord above upright

Cat. No.	Description	Width Options
E3D61 ___ - ___	Single Data Outlet	42", 48", 60", 72", 84", 96"
E3D62 ___ - ___	Double Data Outlet	42", 48", 60", 72", 84", 96"

Example: E3D61G4-48

Envision 3.0 Data for 6" upright, Light Grey, Single Data Outlet, for 48" wide upright

Note: Data is CAT-5E

Envision 3.5
Undermount Bracket
and Shelves

Envision 3.5
Bookend Bracket
and Shelves

Envision 3.5
Plumbing Fixtures

Envision 3.5
Retaining Rods

Envision 3.5
Electric and
Data Location

Envision 3.5
Work Surface
in Epoxy or
Phenolic

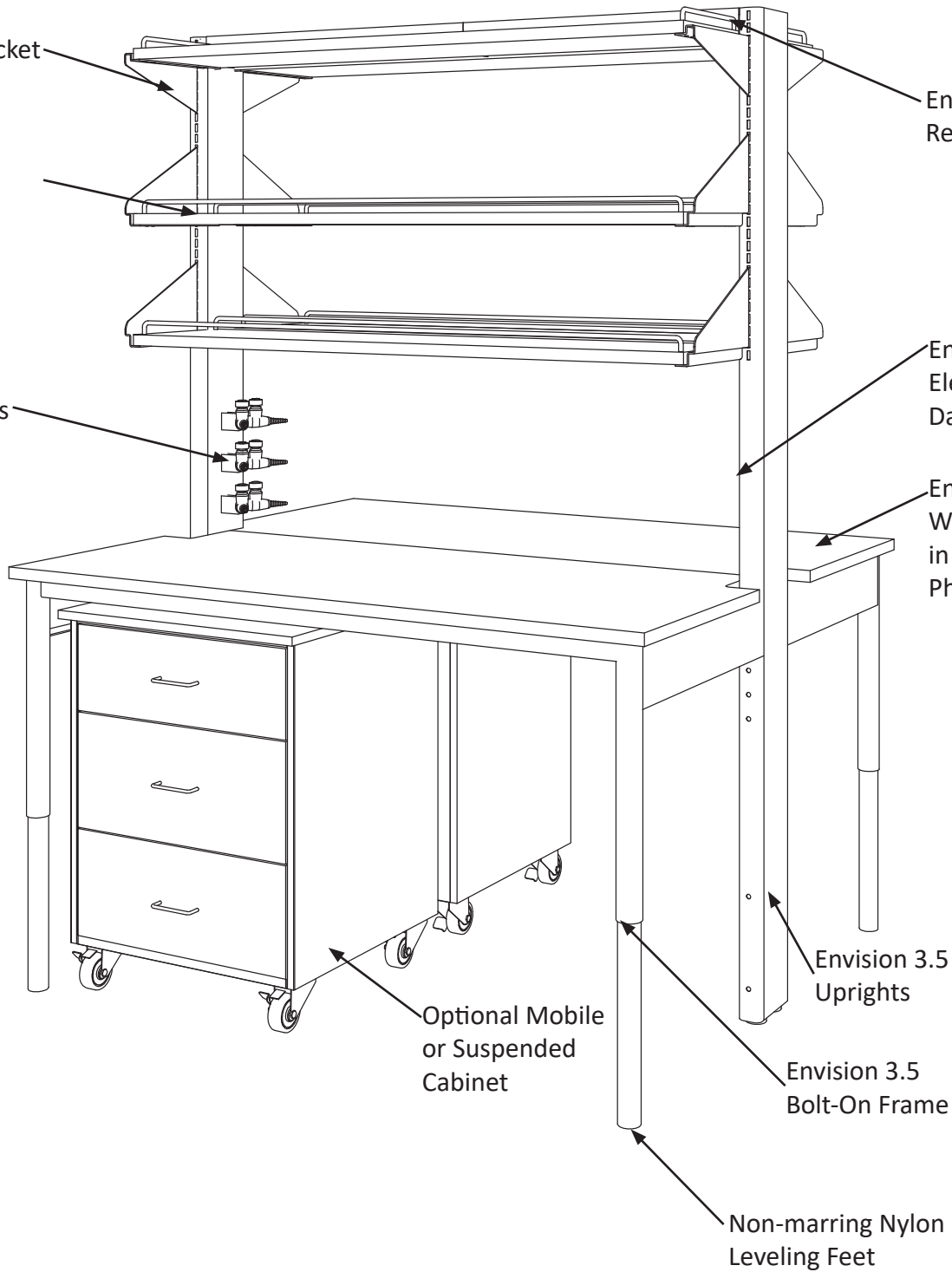

Optional Mobile
or Suspended
Cabinet

Envision 3.5
Uprights

Envision 3.5
Bolt-On Frame

Non-marring Nylon
Leveling Feet

Envision 3.5

Envision 3.5 - 6" Uprights with Plumbing Cutouts Only

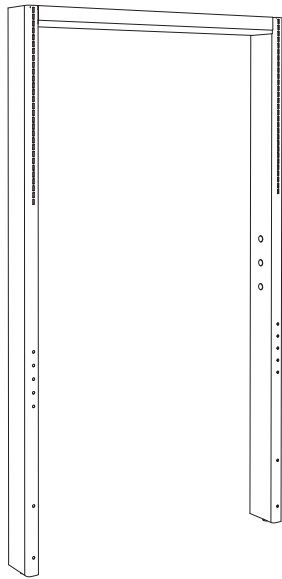

E35U6B-48

- Uprights are 6" Deep Envision 3.5, Double Sided
- Heights is 84"
- For Stainless Steel contact your ICI representative

Includes:

- (3) plumbing cutouts on one side

Cat. No.	Width
E35U6B-42	42"
E35U6B-48	48"
E35U6B-60	60"
E35U6B-72	72"

Envision 3.5 - 6" Uprights with Plumbing, and Data Cutouts Only

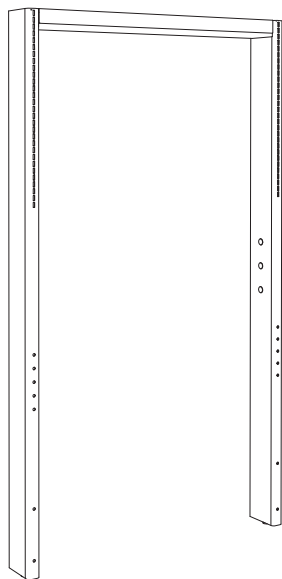

E35U6D-48

- Uprights are 6" Deep Envision 3.5, Double Sided
- Heights is 84"
- For Stainless Steel contact your ICI representative

Includes:

- (3) plumbing cutouts on one side
- (1) data cutout opposite side of plumbing cutouts

Cat. No.	Width
E35U6D-42	42"
E35U6D-48	48"
E35U6D-60	60"
E35U6D-72	72"

Envision 3.5 - 6" Uprights with Plumbing, Data, and Standard Electric Cutouts Only

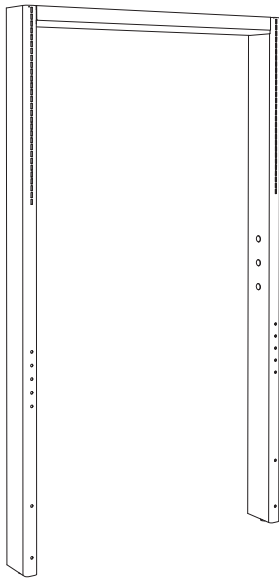

E35U6DE-48

- Uprights are 6" Deep Envision 3.5, Double Sided
- Heights is 84"
- For Stainless Steel contact your ICI representative

Includes:

- (3) plumbing cutouts on one side
- (1) data cutout opposite side of plumbing cutouts
- (6) standard electric cutouts on upper post opposite side of plumbing cutouts
- (2) standard electric cutout on lower post opposite side of the plumbing cutouts

Cat. No.	Width
E35U6DE-42	42"
E35U6DE-48	48"
E35U6DE-60	60"
E35U6DE-72	72"

Envision 3.5 - 6" Uprights with Plumbing, Data, and Standard & GFI Electric Cutouts Only

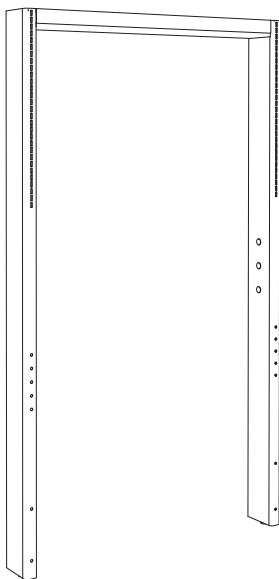

E35U6DEG-48

- Uprights are 6" Deep Envision 3.5, Double Sided
- Heights is 84"
- For Stainless Steel contact your ICI representative

Includes:

- (3) plumbing cutouts on one side
- (1) data cutout opposite side of plumbing cutouts
- (6) standard electric cutouts on upper post opposite side of plumbing cutouts
- (2) GFI electric cutout on lower post opposite side of the plumbing cutouts

Cat. No.	Width
E35U6DEG-42	42"
E35U6DEG-48	48"
E35U6DEG-60	60"
E35U6DEG-72	72"

Envision 3.5

Envision 3.5 - 6" Uprights with Plumbing, and Standard Electric Cutouts Only

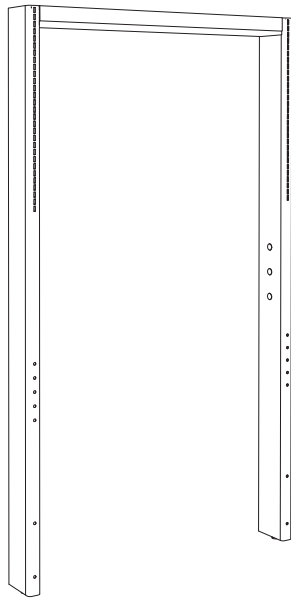

E35U6E-48

- Uprights are 6" Deep Envision 3.5, Double Sided
- Heights is 84"
- For Stainless Steel contact your ICI representative

Includes:

- (3) plumbing cutouts on one side
- (6) standard electric cutouts on upper post opposite side of plumbing cutouts
- (2) standard electric cutout on lower post opposite side of the plumbing cutouts

Cat. No.	Width
E35U6E-42	42"
E35U6E-48	48"
E35U6E-60	60"
E35U6E-72	72"

Envision 3.5 - 6" Uprights with Plumbing, and Standard & GFI Electric Cutouts Only

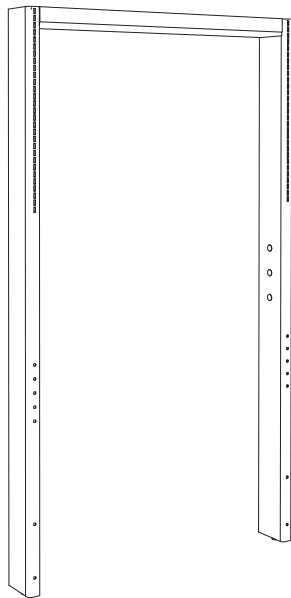

E35U6EG-48

- Uprights are 6" Deep Envision 3.5, Double Sided
- Heights is 84"
- For Stainless Steel contact your ICI representative

Includes:

- (3) plumbing cutouts on one side
- (6) standard electric cutouts on upper post opposite side of plumbing cutouts
- (2) GFI electric cutout on lower post opposite side of the plumbing cutouts

Cat. No.	Width
E35U6EG-42	42"
E35U6EG-48	48"
E35U6EG-60	60"
E35U6EG-72	72"

Envision 3.5 - Bolt-On Frame - 6" Uprights Double Sided

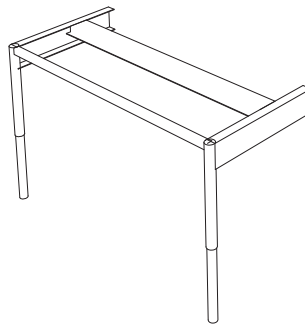
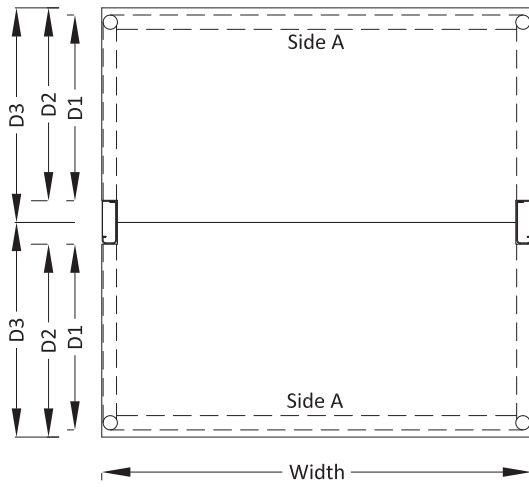

- Envision 3.5 Bolt-On Frames are to be attached to any Envision 3.5 uprights
- (2) Bolt-On Frames can be attached to 6" uprights to make a double sided workstation
- Adjustable Height work surface frame from 30 1/4" - 36 1/4", in 2" increments
- For Stainless Steel, contact your ICI Representative
- Work Surface depth details for Side B listed on next page
- Work Surface depth details for Side A listed below see page 47 for work surface part numbers

Example of Envision 3.5,
6" Upright Double Sided Workstation with
(2) Bolt-on Frames

Bolt-on Frame Cat. No.	Depth of Bolt-on Frame (D1)	Nominal Depth of Bolt-on Frame (D2)	Depth of Work Surface with 3" Notch (D3)	Width
Nominal 21" Deep				
E3CTFB-2142	20"	21"	24"	42"
E3CTFB-2148	20"	21"	24"	48"
E3CTFB-2160	20"	21"	24"	60"
E3CTFB-2172	20"	21"	24"	72"
Nominal 24" Deep				
E3CTFB-2442	23"	24"	27"	42"
E3CTFB-2448	23"	24"	27"	48"
E3CTFB-2460	23"	24"	27"	60"
E3CTFB-2472	23"	24"	27"	72"
Nominal 27" Deep				
E3CTFB-2742	26"	27"	30"	42"
E3CTFB-2748	26"	27"	30"	48"
E3CTFB-2760	26"	27"	30"	60"
E3CTFB-2772	26"	27"	30"	72"
Nominal 30" Deep				
E3CTFB-3042	29"	30"	33"	42"
E3CTFB-3048	29"	30"	33"	48"
E3CTFB-3060	29"	30"	33"	60"
E3CTFB-3072	29"	30"	33"	72"

Envision 3.5

Envision 3.5 - Bolt-On and Table - 6" Uprights Double Sided

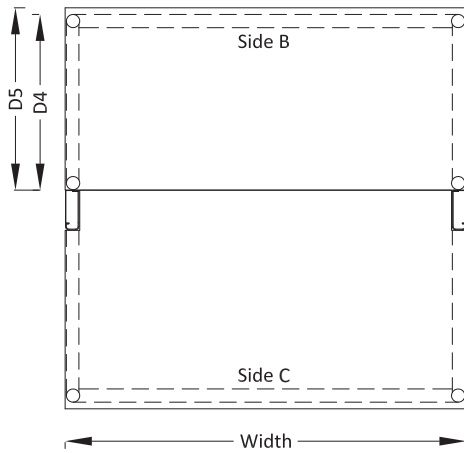

Example of Envision 3.5,
6" Upright Double Sided Workstation with
(1) Bolt-on and (1) Table

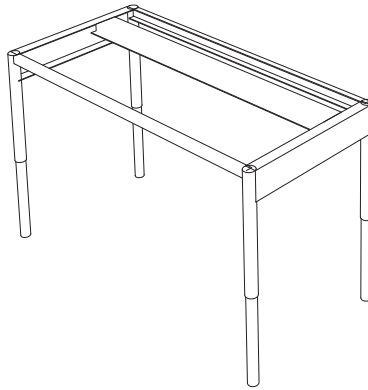

- Envision 3.5 Tables are to be used to make a double sided workstation with a 3" or 6" upright
- Envision 3.5 Tables can also be free standing tables
- Adjustable Height work surface frame from 30 1/4" - 36 1/4", in 2" increments
- For Stainless Steel, contact your ICI Representative
- Work Surface ordered separately
- Work Surface depth details for Side C listed on next page
- Work Surface depth details for Side B listed below see page 49 for work surface part numbers

Bolt-on Frame Cat. No.	Depth of Frame/Table (D4)	Depth of Work Surface with No Notch (D5)	Width
Nominal 15" Deep			
E3CTFT-1542	14"	15"	42"
E3CTFT-1548	14"	15"	48"
E3CTFT-1560	14"	15"	60"
E3CTFT-1572	14"	15"	72"
Nominal 18" Deep			
E3CTFT-1842	17"	18"	42"
E3CTFT-1848	17"	18"	48"
E3CTFT-1860	17"	18"	60"
E3CTFT-1872	17"	18"	72"
Nominal 19" Deep			
E3CTFT-1942	18"	19"	42"
E3CTFT-1948	18"	19"	48"
E3CTFT-1960	18"	19"	60"
E3CTFT-1972	18"	19"	72"
Nominal 21" Deep			
E3CTFT-2142	20"	21"	42"
E3CTFT-2148	20"	21"	48"
E3CTFT-2160	20"	21"	60"
E3CTFT-2172	20"	21"	72"
Nominal 24" Deep			
E3CTFT-2442	23"	24"	42"
E3CTFT-2448	23"	24"	48"
E3CTFT-2460	23"	24"	60"
E3CTFT-2472	23"	24"	72"

Bolt-on Frame Cat. No.	Depth of Frame/Table (D4)	Depth of Work Surface with No Notch (D5)	Width
Nominal 27" Deep			
E3CTFT-2742	26"	27"	42"
E3CTFT-2748	26"	27"	48"
E3CTFT-2760	26"	27"	60"
E3CTFT-2772	26"	27"	72"
Nominal 30" Deep			
E3CTFT-3042	29"	30"	42"
E3CTFT-3048	29"	30"	48"
E3CTFT-3060	29"	30"	60"
E3CTFT-3072	29"	30"	72"
Nominal 33" Deep			
E3CTFT-3342	32"	33"	42"
E3CTFT-3348	32"	33"	48"
E3CTFT-3360	32"	33"	60"
E3CTFT-3372	32"	33"	72"
Nominal 36" Deep			
E3CTFT-3642	35"	36"	42"
E3CTFT-3648	35"	36"	48"
E3CTFT-3660	35"	36"	60"
E3CTFT-3672	35"	36"	72"

Envision 3.5 - Bolt-On and Table - 6" Uprights Double Sided

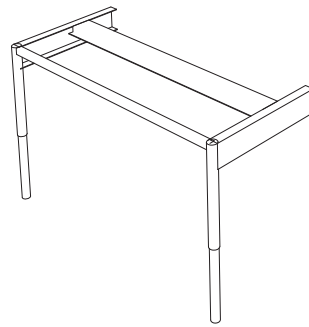
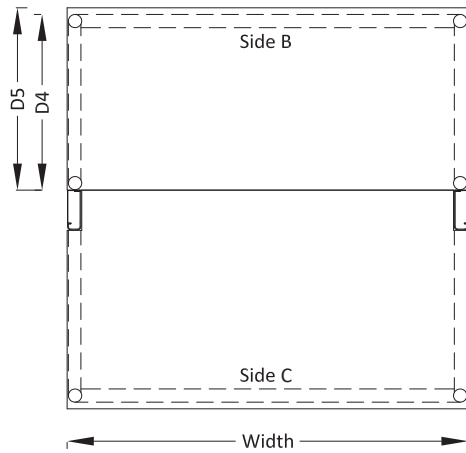

- Envision 3.5 Bolt-On Frames are to be attached to any Envision 3.5 uprights
- (2) Bolt-On Frames can be attached to 6" uprights to make a double sided workstation
- Adjustable Height work surface frame from 30 1/4" - 36 1/4", in 2" increments
- For Stainless Steel, contact your ICI Representative
- Work Surface depth details for Side B listed on next page
- Work Surface depth details for Side A listed below see page 48 for work surface part numbers

Example of Envision 3.5, 6" Upright Double Sided Workstation with (1) Bolt-on and (1) Table

Bolt-on Frame Cat. No.	Depth of Bolt-on Frame (D1)	Nominal Depth of Bolt-on Frame (D2)	Depth of Work Surface with 6" Notch (D3)	Width
Nominal 21" Deep				
E3CTFB-2142	20"	21"	27"	42"
E3CTFB-2148	20"	21"	27"	48"
E3CTFB-2160	20"	21"	27"	60"
E3CTFB-2172	20"	21"	27"	72"
Nominal 24" Deep				
E3CTFB-2442	23"	24"	30"	42"
E3CTFB-2448	23"	24"	30"	48"
E3CTFB-2460	23"	24"	30"	60"
E3CTFB-2472	23"	24"	30"	72"
Nominal 27" Deep				
E3CTFB-2742	26"	27"	33"	42"
E3CTFB-2748	26"	27"	33"	48"
E3CTFB-2760	26"	27"	33"	60"
E3CTFB-2772	26"	27"	33"	72"
Nominal 30" Deep				
E3CTFB-3042	29"	30"	36"	42"
E3CTFB-3048	29"	30"	36"	48"
E3CTFB-3060	29"	30"	36"	60"
E3CTFB-3072	29"	30"	36"	72"

Envision 3.5

Envision 3.5 - 6" Upright Notched Work Surface

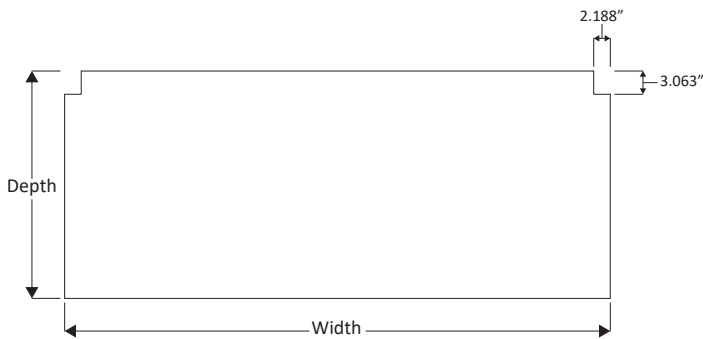

- This work surface is to be used with Envision 3.5, 6" upright with (2) Bolt-On Frames

Epoxy	Cat. No. Phenolic	Stainless Steel	Width
24" Deep Top			
E3CT1ER3-2442	E3CT1PH3-2442	E3CT1SS3-2442	42"
E3CT1ER3-2448	E3CT1PH3-2448	E3CT1SS3-2448	48"
E3CT1ER3-2460	E3CT1PH3-2460	E3CT1SS3-2460	60"
E3CT1ER3-2472	E3CT1PH3-2472	E3CT1SS3-2472	72"
27" Deep Top			
E3CT1ER3-2742	E3CT1PH3-2742	E3CT1SS3-2742	42"
E3CT1ER3-2748	E3CT1PH3-2748	E3CT1SS3-2748	48"
E3CT1ER3-2760	E3CT1PH3-2760	E3CT1SS3-2760	60"
E3CT1ER3-2772	E3CT1PH3-2772	E3CT1SS3-2772	72"
30" Deep Top			
E3CT1ER3-3042	E3CT1PH3-3042	E3CT1SS3-3042	42"
E3CT1ER3-3048	E3CT1PH3-3048	E3CT1SS3-3048	48"
E3CT1ER3-3060	E3CT1PH3-3060	E3CT1SS3-3060	60"
E3CT1ER3-3072	E3CT1PH3-3072	E3CT1SS3-3072	72"
33" Deep Top			
E3CT1ER3-3342	E3CT1PH3-3342	E3CT1SS3-3342	42"
E3CT1ER3-3348	E3CT1PH3-3348	E3CT1SS3-3348	48"
E3CT1ER3-3360	E3CT1PH3-3360	E3CT1SS3-3360	60"
E3CT1ER3-3372	E3CT1PH3-3372	E3CT1SS3-3372	72"
36" Deep Top			
E3CT1ER3-3642	E3CT1PH3-3642	E3CT1SS3-3642	42"
E3CT1ER3-3648	E3CT1PH3-3648	E3CT1SS3-3648	48"
E3CT1ER3-3660	E3CT1PH3-3660	E3CT1SS3-3660	60"
E3CT1ER3-3672	E3CT1PH3-3672	E3CT1SS3-3672	72"

Envision 3.5 - 6" Upright Notched Work Surface

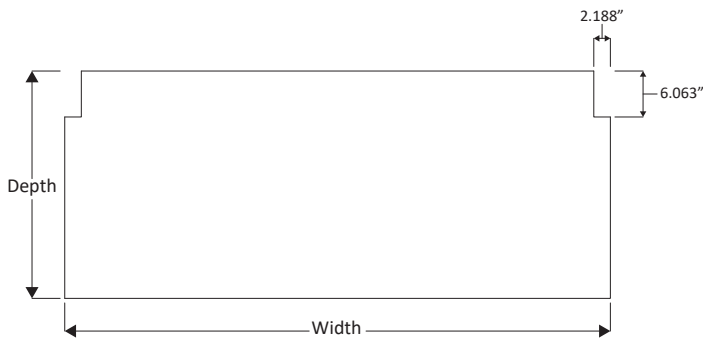

- This work surface is to be used with Envision 3.5, 6" upright when (1) Bolt-On Frame is used

Epoxy	Cat. No. Phenolic	Stainless Steel	Width
27" Deep Top			
E3CT1ER6-2742	E3CT1PH6-2742	E3CT1SS6-2742	42"
E3CT1ER6-2748	E3CT1PH6-2748	E3CT1SS6-2748	48"
E3CT1ER6-2760	E3CT1PH6-2760	E3CT1SS6-2760	60"
E3CT1ER6-2772	E3CT1PH6-2772	E3CT1SS6-2772	72"
30" Deep Top			
E3CT1ER6-3042	E3CT1PH6-3042	E3CT1SS6-3042	42"
E3CT1ER6-3048	E3CT1PH6-3048	E3CT1SS6-3048	48"
E3CT1ER6-3060	E3CT1PH6-3060	E3CT1SS6-3060	60"
E3CT1ER6-3072	E3CT1PH6-3072	E3CT1SS6-3072	72"
33" Deep Top			
E3CT1ER6-3342	E3CT1PH6-3342	E3CT1SS6-3342	42"
E3CT1ER6-3348	E3CT1PH6-3348	E3CT1SS6-3348	48"
E3CT1ER6-3360	E3CT1PH6-3360	E3CT1SS6-3360	60"
E3CT1ER6-3372	E3CT1PH6-3372	E3CT1SS6-3372	72"
36" Deep Top			
E3CT1ER6-3642	E3CT1PH6-3642	E3CT1SS6-3642	42"
E3CT1ER6-3648	E3CT1PH6-3648	E3CT1SS6-3648	48"
E3CT1ER6-3660	E3CT1PH6-3660	E3CT1SS6-3660	60"
E3CT1ER6-3672	E3CT1PH6-3672	E3CT1SS6-3672	72"

Envision 3.5

Envision 3.5 - No Notch Work Surface

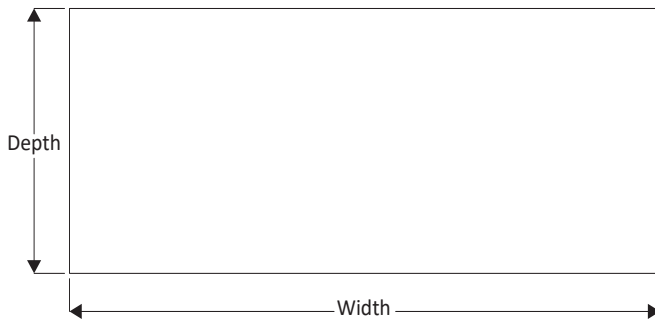

- This work surface is to be used with an Envision 3.5 Frame/ Table

15" Deep Top				27" Deep Top			
Epoxy	Cat. No. Phenolic	Stainless Steel	Width	Epoxy	Cat. No. Phenolic	Stainless Steel	Width
E3CT1ERT-1542	E3CT1PHT-1542	E3CT1SST-1542	42"	E3CT1ERT-2742	E3CT1PHT-2742	E3CT1SST-2742	42"
E3CT1ERT-1548	E3CT1PHT-1548	E3CT1SST-1548	48"	E3CT1ERT-2748	E3CT1PHT-2748	E3CT1SST-2748	48"
E3CT1ERT-1560	E3CT1PHT-1560	E3CT1SST-1560	60"	E3CT1ERT-2760	E3CT1PHT-2760	E3CT1SST-2760	60"
E3CT1ERT-1572	E3CT1PHT-1572	E3CT1SST-1572	72"	E3CT1ERT-2772	E3CT1PHT-2772	E3CT1SST-2772	72"
18" Deep Top				30" Deep Top			
E3CT1ERT-1842	E3CT1PHT-1842	E3CT1SST-1842	42"	E3CT1ERT-3042	E3CT1PHT-3042	E3CT1SST-3042	42"
E3CT1ERT-1848	E3CT1PHT-1848	E3CT1SST-1848	48"	E3CT1ERT-3048	E3CT1PHT-3048	E3CT1SST-3048	48"
E3CT1ERT-1860	E3CT1PHT-1860	E3CT1SST-1860	60"	E3CT1ERT-3060	E3CT1PHT-3060	E3CT1SST-3060	60"
E3CT1ERT-1872	E3CT1PHT-1872	E3CT1SST-1872	72"	E3CT1ERT-3072	E3CT1PHT-3072	E3CT1SST-3072	72"
19" Deep Top				33" Deep Top			
E3CT1ERT-1942	E3CT1PHT-1942	E3CT1SST-1942	42"	E3CT1ERT-3342	E3CT1PHT-3342	E3CT1SST-3342	42"
E3CT1ERT-1948	E3CT1PHT-1948	E3CT1SST-1948	48"	E3CT1ERT-3348	E3CT1PHT-3348	E3CT1SST-3348	48"
E3CT1ERT-1960	E3CT1PHT-1960	E3CT1SST-1960	60"	E3CT1ERT-3360	E3CT1PHT-3360	E3CT1SST-3360	60"
E3CT1ERT-1972	E3CT1PHT-1972	E3CT1SST-1972	72"	E3CT1ERT-3372	E3CT1PHT-3372	E3CT1SST-3372	72"
21" Deep Top				36" Deep Top			
E3CT1ERT-2142	E3CT1PHT-2142	E3CT1SST-2142	42"	E3CT1ERT-3642	E3CT1PHT-3642	E3CT1SST-3642	42"
E3CT1ERT-2148	E3CT1PHT-2148	E3CT1SST-2148	48"	E3CT1ERT-3648	E3CT1PHT-3648	E3CT1SST-3648	48"
E3CT1ERT-2160	E3CT1PHT-2160	E3CT1SST-2160	60"	E3CT1ERT-3660	E3CT1PHT-3660	E3CT1SST-3660	60"
E3CT1ERT-2172	E3CT1PHT-2172	E3CT1SST-2172	72"	E3CT1ERT-3672	E3CT1PHT-3672	E3CT1SST-3672	72"
24" Deep Top							
E3CT1ERT-2442	E3CT1PHT-2442	E3CT1SST-2442	42"				
E3CT1ERT-2448	E3CT1PHT-2448	E3CT1SST-2448	48"				
E3CT1ERT-2460	E3CT1PHT-2460	E3CT1SST-2460	60"				
E3CT1ERT-2472	E3CT1PHT-2472	E3CT1SST-2472	72"				

Envision 3.5 - .75" Thick Shelving - No Rear Rod Cutout

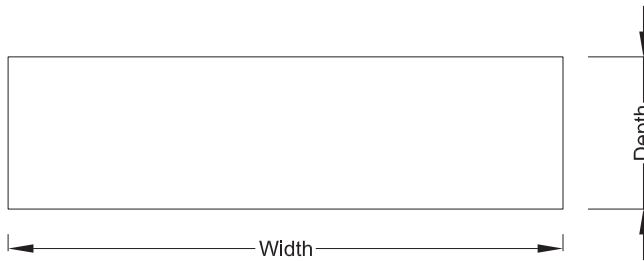

- These shelves to be used with Envision 3.5 brackets
- Each part number includes (1) shelf

Epoxy	Cat. No. Phenolic	Painted Steel	Stainless Steel	Wood - Maple	Wood - Oak	Actual Width	For Use With:
9.5" Deep							
E35S75ER-9542	E35S75PH-9542	E35S75MS-9542	E35S75SS-9542	E35S75WM-9542	E35S75WO-9542	37.75"	42" Wide Upright
E35S75ER-9548	E35S75PH-9548	E35S75MS-9548	E35S75SS-9548	E35S75WM-9548	E35S75WO-9548	43.75"	48" Wide Upright
E35S75ER-9560	E35S75PH-9560	E35S75MS-9560	E35S75SS-9560	E35S75WM-9560	E35S75WO-9560	55.75"	60" Wide Upright
E35S75ER-9572	E35S75PH-9572	E35S75MS-9572	E35S75SS-9572	E35S75WM-9572	E35S75WO-9572	67.75"	72" Wide Upright
12" Deep							
E35S75ER-1242	E35S75PH-1242	E35S75MS-1242	E35S75SS-1242	E35S75WM-1242	E35S75WO-1242	37.75"	42" Wide Upright
E35S75ER-1248	E35S75PH-1248	E35S75MS-1248	E35S75SS-1248	E35S75WM-1248	E35S75WO-1248	43.75"	48" Wide Upright
E35S75ER-1260	E35S75PH-1260	E35S75MS-1260	E35S75SS-1260	E35S75WM-1260	E35S75WO-1260	55.75"	60" Wide Upright
E35S75ER-1272	E35S75PH-1272	E35S75MS-1272	E35S75SS-1272	E35S75WM-1272	E35S75WO-1272	67.75"	72" Wide Upright
13" Deep							
E35S75ER-1342	E35S75PH-1342	E35S75MS-1342	E35S75SS-1342	E35S75WM-1342	E35S75WO-1342	37.75"	42" Wide Upright
E35S75ER-1348	E35S75PH-1348	E35S75MS-1348	E35S75SS-1348	E35S75WM-1348	E35S75WO-1348	43.75"	48" Wide Upright
E35S75ER-1360	E35S75PH-1360	E35S75MS-1360	E35S75SS-1360	E35S75WM-1360	E35S75WO-1360	55.75"	60" Wide Upright
E35S75ER-1372	E35S75PH-1372	E35S75MS-1372	E35S75SS-1372	E35S75WM-1372	E35S75WO-1372	67.75"	72" Wide Upright
15" Deep							
E35S75ER-1542	E35S75PH-1542	E35S75MS-1542	E35S75SS-1542	E35S75WM-1542	E35S75WO-1542	37.75"	42" Wide Upright
E35S75ER-1548	E35S75PH-1548	E35S75MS-1548	E35S75SS-1548	E35S75WM-1548	E35S75WO-1548	43.75"	48" Wide Upright
E35S75ER-1560	E35S75PH-1560	E35S75MS-1560	E35S75SS-1560	E35S75WM-1560	E35S75WO-1560	55.75"	60" Wide Upright
E35S75ER-1572	E35S75PH-1572	E35S75MS-1572	E35S75SS-1572	E35S75WM-1572	E35S75WO-1572	67.75"	72" Wide Upright
16" Deep							
E35S75ER-1642	E35S75PH-1642	E35S75MS-1642	E35S75SS-1642	E35S75WM-1642	E35S75WO-1642	37.75"	42" Wide Upright
E35S75ER-1648	E35S75PH-1648	E35S75MS-1648	E35S75SS-1648	E35S75WM-1648	E35S75WO-1648	43.75"	48" Wide Upright
E35S75ER-1660	E35S75PH-1660	E35S75MS-1660	E35S75SS-1660	E35S75WM-1660	E35S75WO-1660	55.75"	60" Wide Upright
E35S75ER-1672	E35S75PH-1672	E35S75MS-1672	E35S75SS-1672	E35S75WM-1672	E35S75WO-1672	67.75"	72" Wide Upright
18" Deep							
E35S75ER-1842	E35S75PH-1842	E35S75MS-1842	E35S75SS-1842	E35S75WM-1842	E35S75WO-1842	37.75"	42" Wide Upright
E35S75ER-1848	E35S75PH-1848	E35S75MS-1848	E35S75SS-1848	E35S75WM-1848	E35S75WO-1848	43.75"	48" Wide Upright
E35S75ER-1860	E35S75PH-1860	E35S75MS-1860	E35S75SS-1860	E35S75WM-1860	E35S75WO-1860	55.75"	60" Wide Upright
E35S75ER-1872	E35S75PH-1872	E35S75MS-1872	E35S75SS-1872	E35S75WM-1872	E35S75WO-1872	67.75"	72" Wide Upright

Envision 3.5

Envision 3.5 - 1" Thick Shelving - No Rear Rod Cutout

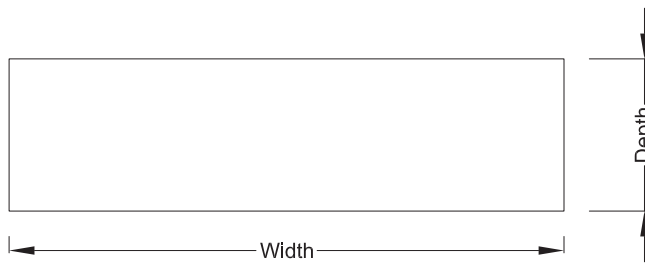

- These shelves to be used with Envision 3.5 brackets
- Each part number includes (1) shelf

Epoxy	Cat. No.		Painted Steel	Stainless Steel	Wood - Maple	Wood - Oak	Actual Width	For Use With:
	Phenolic							
9.5" Deep								
E35S1ER-9542	E35S1PH-9542	E35S1MS-9542	E35S1SS-9542	E35S1WM-9542	E35S1WO-9542	37.75"	42" Wide Upright	
E35S1ER-9548	E35S1PH-9548	E35S1MS-9548	E35S1SS-9548	E35S1WM-9548	E35S1WO-9548	43.75"	48" Wide Upright	
E35S1ER-9560	E35S1PH-9560	E35S1MS-9560	E35S1SS-9560	E35S1WM-9560	E35S1WO-9560	55.75"	60" Wide Upright	
E35S1ER-9572	E35S1PH-9572	E35S1MS-9572	E35S1SS-9572	E35S1WM-9572	E35S1WO-9572	67.75"	72" Wide Upright	
12" Deep								
E35S1ER-1242	E35S1PH-1242	E35S1MS-1242	E35S1SS-1242	E35S1WM-1242	E35S1WO-1242	37.75"	42" Wide Upright	
E35S1ER-1248	E35S1PH-1248	E35S1MS-1248	E35S1SS-1248	E35S1WM-1248	E35S1WO-1248	43.75"	48" Wide Upright	
E35S1ER-1260	E35S1PH-1260	E35S1MS-1260	E35S1SS-1260	E35S1WM-1260	E35S1WO-1260	55.75"	60" Wide Upright	
E35S1ER-1272	E35S1PH-1272	E35S1MS-1272	E35S1SS-1272	E35S1WM-1272	E35S1WO-1272	67.75"	72" Wide Upright	
13" Deep								
E35S1ER-1342	E35S1PH-1342	E35S1MS-1342	E35S1SS-1342	E35S1WM-1342	E35S1WO-1342	37.75"	42" Wide Upright	
E35S1ER-1348	E35S1PH-1348	E35S1MS-1348	E35S1SS-1348	E35S1WM-1348	E35S1WO-1348	43.75"	48" Wide Upright	
E35S1ER-1360	E35S1PH-1360	E35S1MS-1360	E35S1SS-1360	E35S1WM-1360	E35S1WO-1360	55.75"	60" Wide Upright	
E35S1ER-1372	E35S1PH-1372	E35S1MS-1372	E35S1SS-1372	E35S1WM-1372	E35S1WO-1372	67.75"	72" Wide Upright	
15" Deep								
E35S1ER-1542	E35S1PH-1542	E35S1MS-1542	E35S1SS-1542	E35S1WM-1542	E35S1WO-1542	37.75"	42" Wide Upright	
E35S1ER-1548	E35S1PH-1548	E35S1MS-1548	E35S1SS-1548	E35S1WM-1548	E35S1WO-1548	43.75"	48" Wide Upright	
E35S1ER-1560	E35S1PH-1560	E35S1MS-1560	E35S1SS-1560	E35S1WM-1560	E35S1WO-1560	55.75"	60" Wide Upright	
E35S1ER-1572	E35S1PH-1572	E35S1MS-1572	E35S1SS-1572	E35S1WM-1572	E35S1WO-1572	67.75"	72" Wide Upright	
16" Deep								
E35S1ER-1642	E35S1PH-1642	E35S1MS-1642	E35S1SS-1642	E35S1WM-1642	E35S1WO-1642	37.75"	42" Wide Upright	
E35S1ER-1648	E35S1PH-1648	E35S1MS-1648	E35S1SS-1648	E35S1WM-1648	E35S1WO-1648	43.75"	48" Wide Upright	
E35S1ER-1660	E35S1PH-1660	E35S1MS-1660	E35S1SS-1660	E35S1WM-1660	E35S1WO-1660	55.75"	60" Wide Upright	
E35S1ER-1672	E35S1PH-1672	E35S1MS-1672	E35S1SS-1672	E35S1WM-1672	E35S1WO-1672	67.75"	72" Wide Upright	
18" Deep								
E35S1ER-1842	E35S1PH-1842	E35S1MS-1842	E35S1SS-1842	E35S1WM-1842	E35S1WO-1842	37.75"	42" Wide Upright	
E35S1ER-1848	E35S1PH-1848	E35S1MS-1848	E35S1SS-1848	E35S1WM-1848	E35S1WO-1848	43.75"	48" Wide Upright	
E35S1ER-1860	E35S1PH-1860	E35S1MS-1860	E35S1SS-1860	E35S1WM-1860	E35S1WO-1860	55.75"	60" Wide Upright	
E35S1ER-1872	E35S1PH-1872	E35S1MS-1872	E35S1SS-1872	E35S1WM-1872	E35S1WO-1872	67.75"	72" Wide Upright	

Envision 3.5 - .75" Thick Shelving with Cutouts for Rear Rod

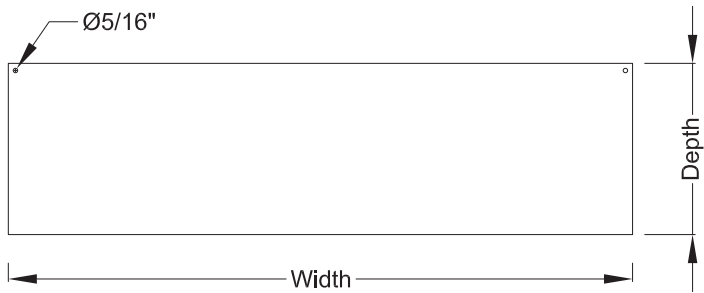

- These shelves to be used with Envision 3.5 brackets
- Each part number includes (1) shelf
- These shelves include cutouts for rear rod

Epoxy	Cat. No. Phenolic	Painted Steel	Stainless Steel	Wood - Maple	Wood - Oak	Actual Width	For Use With:
9.5" Deep							
E35S75ERR-9542	E35S75PHR-9542	E35S75MSR-9542	E35S75SSR-9542	E35S75WMMR-9542	E35S75WOR-9542	37.75"	42" Wide Upright
E35S75ERR-9548	E35S75PHR-9548	E35S75MSR-9548	E35S75SSR-9548	E35S75WMMR-9548	E35S75WOR-9548	43.75"	48" Wide Upright
E35S75ERR-9560	E35S75PHR-9560	E35S75MSR-9560	E35S75SSR-9560	E35S75WMMR-9560	E35S75WOR-9560	55.75"	60" Wide Upright
E35S75ERR-9572	E35S75PHR-9572	E35S75MSR-9572	E35S75SSR-9572	E35S75WMMR-9572	E35S75WOR-9572	67.75"	72" Wide Upright
12" Deep							
E35S75ERR-1242	E35S75PHR-1242	E35S75MSR-1242	E35S75SSR-1242	E35S75WMMR-1242	E35S75WOR-1242	37.75"	42" Wide Upright
E35S75ERR-1248	E35S75PHR-1248	E35S75MSR-1248	E35S75SSR-1248	E35S75WMMR-1248	E35S75WOR-1248	43.75"	48" Wide Upright
E35S75ERR-1260	E35S75PHR-1260	E35S75MSR-1260	E35S75SSR-1260	E35S75WMMR-1260	E35S75WOR-1260	55.75"	60" Wide Upright
E35S75ERR-1272	E35S75PHR-1272	E35S75MSR-1272	E35S75SSR-1272	E35S75WMMR-1272	E35S75WOR-1272	67.75"	72" Wide Upright
13" Deep							
E35S75ERR-1342	E35S75PHR-1342	E35S75MSR-1342	E35S75SSR-1342	E35S75WMMR-1342	E35S75WOR-1342	37.75"	42" Wide Upright
E35S75ERR-1348	E35S75PHR-1348	E35S75MSR-1348	E35S75SSR-1348	E35S75WMMR-1348	E35S75WOR-1348	43.75"	48" Wide Upright
E35S75ERR-1360	E35S75PHR-1360	E35S75MSR-1360	E35S75SSR-1360	E35S75WMMR-1360	E35S75WOR-1360	55.75"	60" Wide Upright
E35S75ERR-1372	E35S75PHR-1372	E35S75MSR-1372	E35S75SSR-1372	E35S75WMMR-1372	E35S75WOR-1372	67.75"	72" Wide Upright
15" Deep							
E35S75ERR-1542	E35S75PHR-1542	E35S75MSR-1542	E35S75SSR-1542	E35S75WMMR-1542	E35S75WOR-1542	37.75"	42" Wide Upright
E35S75ERR-1548	E35S75PHR-1548	E35S75MSR-1548	E35S75SSR-1548	E35S75WMMR-1548	E35S75WOR-1548	43.75"	48" Wide Upright
E35S75ERR-1560	E35S75PHR-1560	E35S75MSR-1560	E35S75SSR-1560	E35S75WMMR-1560	E35S75WOR-1560	55.75"	60" Wide Upright
E35S75ERR-1572	E35S75PHR-1572	E35S75MSR-1572	E35S75SSR-1572	E35S75WMMR-1572	E35S75WOR-1572	67.75"	72" Wide Upright
16" Deep							
E35S75ERR-1642	E35S75PHR-1642	E35S75MSR-1642	E35S75SSR-1642	E35S75WMMR-1642	E35S75WOR-1642	37.75"	42" Wide Upright
E35S75ERR-1648	E35S75PHR-1648	E35S75MSR-1648	E35S75SSR-1648	E35S75WMMR-1648	E35S75WOR-1648	43.75"	48" Wide Upright
E35S75ERR-1660	E35S75PHR-1660	E35S75MSR-1660	E35S75SSR-1660	E35S75WMMR-1660	E35S75WOR-1660	55.75"	60" Wide Upright
E35S75ERR-1672	E35S75PHR-1672	E35S75MSR-1672	E35S75SSR-1672	E35S75WMMR-1672	E35S75WOR-1672	67.75"	72" Wide Upright
18" Deep							
E35S75ERR-1842	E35S75PHR-1842	E35S75MSR-1842	E35S75SSR-1842	E35S75WMMR-1842	E35S75WOR-1842	37.75"	42" Wide Upright
E35S75ERR-1848	E35S75PHR-1848	E35S75MSR-1848	E35S75SSR-1848	E35S75WMMR-1848	E35S75WOR-1848	43.75"	48" Wide Upright
E35S75ERR-1860	E35S75PHR-1860	E35S75MSR-1860	E35S75SSR-1860	E35S75WMMR-1860	E35S75WOR-1860	55.75"	60" Wide Upright
E35S75ERR-1872	E35S75PHR-1872	E35S75MSR-1872	E35S75SSR-1872	E35S75WMMR-1872	E35S75WOR-1872	67.75"	72" Wide Upright

Envision 3.5

Envision 3.5 - 1" Thick Shelving with Cutouts for Rear Rod

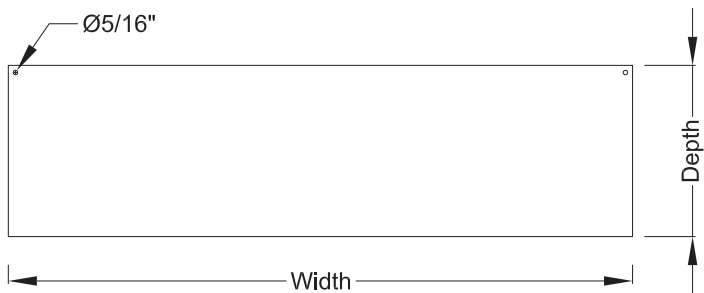

- These shelves to be used with Envision 3.5 brackets
- Each part number includes (1) shelf
- These shelves include cutouts for rear rod

Epoxy	Cat. No.		Painted Steel	Stainless Steel	Wood - Maple	Wood - Oak	Actual Width	For Use With:
	Phenolic							
9.5" Deep								
E35S1ERR-9542	E35S1PHR-9542	E35S1MSR-9542	E35S1SSR-9542	E35S1WMR-9542	E35S1WOR-9542	37.75"	42" Wide Upright	
E35S1ERR-9548	E35S1PHR-9548	E35S1MSR-9548	E35S1SSR-9548	E35S1WMR-9548	E35S1WOR-9548	43.75"	48" Wide Upright	
E35S1ERR-9560	E35S1PHR-9560	E35S1MSR-9560	E35S1SSR-9560	E35S1WMR-9560	E35S1WOR-9560	55.75"	60" Wide Upright	
E35S1ERR-9572	E35S1PHR-9572	E35S1MSR-9572	E35S1SSR-9572	E35S1WMR-9572	E35S1WOR-9572	67.75"	72" Wide Upright	
12" Deep								
E35S1ERR-1242	E35S1PHR-1242	E35S1MSR-1242	E35S1SSR-1242	E35S1WMR-1242	E35S1WOR-1242	37.75"	42" Wide Upright	
E35S1ERR-1248	E35S1PHR-1248	E35S1MSR-1248	E35S1SSR-1248	E35S1WMR-1248	E35S1WOR-1248	43.75"	48" Wide Upright	
E35S1ERR-1260	E35S1PHR-1260	E35S1MSR-1260	E35S1SSR-1260	E35S1WMR-1260	E35S1WOR-1260	55.75"	60" Wide Upright	
E35S1ERR-1272	E35S1PHR-1272	E35S1MSR-1272	E35S1SSR-1272	E35S1WMR-1272	E35S1WOR-1272	67.75"	72" Wide Upright	
13" Deep								
E35S1ERR-1342	E35S1PHR-1342	E35S1MSR-1342	E35S1SSR-1342	E35S1WMR-1342	E35S1WOR-1342	37.75"	42" Wide Upright	
E35S1ERR-1348	E35S1PHR-1348	E35S1MSR-1348	E35S1SSR-1348	E35S1WMR-1348	E35S1WOR-1348	43.75"	48" Wide Upright	
E35S1ERR-1360	E35S1PHR-1360	E35S1MSR-1360	E35S1SSR-1360	E35S1WMR-1360	E35S1WOR-1360	55.75"	60" Wide Upright	
E35S1ERR-1372	E35S1PHR-1372	E35S1MSR-1372	E35S1SSR-1372	E35S1WMR-1372	E35S1WOR-1372	67.75"	72" Wide Upright	
15" Deep								
E35S1ERR-1542	E35S1PHR-1542	E35S1MSR-1542	E35S1SSR-1542	E35S1WMR-1542	E35S1WOR-1542	37.75"	42" Wide Upright	
E35S1ERR-1548	E35S1PHR-1548	E35S1MSR-1548	E35S1SSR-1548	E35S1WMR-1548	E35S1WOR-1548	43.75"	48" Wide Upright	
E35S1ERR-1560	E35S1PHR-1560	E35S1MSR-1560	E35S1SSR-1560	E35S1WMR-1560	E35S1WOR-1560	55.75"	60" Wide Upright	
E35S1ERR-1572	E35S1PHR-1572	E35S1MSR-1572	E35S1SSR-1572	E35S1WMR-1572	E35S1WOR-1572	67.75"	72" Wide Upright	
16" Deep								
E35S1ERR-1642	E35S1PHR-1642	E35S1MSR-1642	E35S1SSR-1642	E35S1WMR-1642	E35S1WOR-1642	37.75"	42" Wide Upright	
E35S1ERR-1648	E35S1PHR-1648	E35S1MSR-1648	E35S1SSR-1648	E35S1WMR-1648	E35S1WOR-1648	43.75"	48" Wide Upright	
E35S1ERR-1660	E35S1PHR-1660	E35S1MSR-1660	E35S1SSR-1660	E35S1WMR-1660	E35S1WOR-1660	55.75"	60" Wide Upright	
E35S1ERR-1672	E35S1PHR-1672	E35S1MSR-1672	E35S1SSR-1672	E35S1WMR-1672	E35S1WOR-1672	67.75"	72" Wide Upright	
18" Deep								
E35S1ERR-1842	E35S1PHR-1842	E35S1MSR-1842	E35S1SSR-1842	E35S1WMR-1842	E35S1WOR-1842	37.75"	42" Wide Upright	
E35S1ERR-1848	E35S1PHR-1848	E35S1MSR-1848	E35S1SSR-1848	E35S1WMR-1848	E35S1WOR-1848	43.75"	48" Wide Upright	
E35S1ERR-1860	E35S1PHR-1860	E35S1MSR-1860	E35S1SSR-1860	E35S1WMR-1860	E35S1WOR-1860	55.75"	60" Wide Upright	
E35S1ERR-1872	E35S1PHR-1872	E35S1MSR-1872	E35S1SSR-1872	E35S1WMR-1872	E35S1WOR-1872	67.75"	72" Wide Upright	

Envision 3.5 - Bookend Brackets

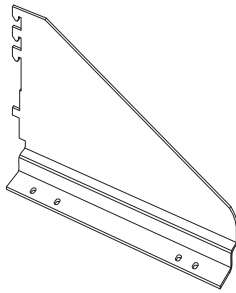

- These brackets to be used with Envision 3.5 uprights
- Sold in pairs

Cat. No.		Depth
Painted Steel	Stainless Steel	
.75" Thick Shelf		
E3SBB75-9	E3SBB75-9S	9"
E3SBB75-12	E3SBB75-12S	12"
E3SBB75-15	E3SBB75-15S	15"
1" Thick Shelf		
E3SBB1-9	E3SBB1-9S	9"
E3SBB1-12	E3SBB1-12S	12"
E3SBB1-15	E3SBB1-15S	15"

Envision 3.5 - Inverted Brackets

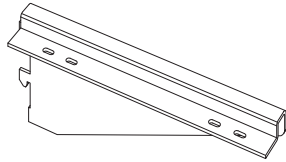

- These brackets to be used with Envision 3.5 uprights
- Sold in pairs

Cat. No.		Depth
Painted Steel	Stainless Steel	
.75" Thick Shelf		
E3SBI75-9	E3SBI75-9S	9"
E3SBI75-12	E3SBI75-12S	12"
E3SBI75-15	E3SBI75-15S	15"
1" Thick Shelf		
E3SBI1-9	E3SBI1-9S	9"
E3SBI1-12	E3SBI1-12S	12"
E3SBI1-15	E3SBI1-15S	15"

Envision 3.5 - Shelf Lip

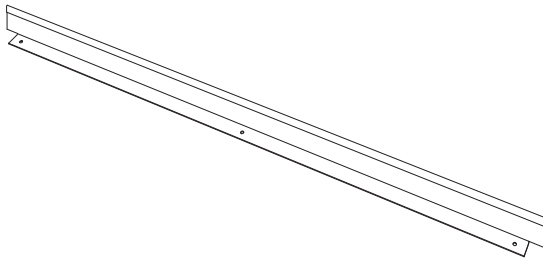

- These shelf lips to be used with Envision 3.5 shelves

Cat. No.		Width
Painted Steel	Stainless Steel	
Shelf Lip Front Mount		
E35SLF-42	E35SLF-42S	37.75"
E35SLF-48	E35SLF-48S	43.75"
E35SLF-60	E35SLF-60S	55.75"
E35SLF-72	E35SLF-72S	67.75"
Shelf Lip Rear Mount		
E35SLR-42	E35SLR-42S	37.75"
E35SLR-48	E35SLR-48S	43.75"
E35SLR-60	E35SLR-60S	55.75"
E35SLR-72	E35SLR-72S	67.75"

Envision 3.5

Envision 3.5 - Front Shelf Rod

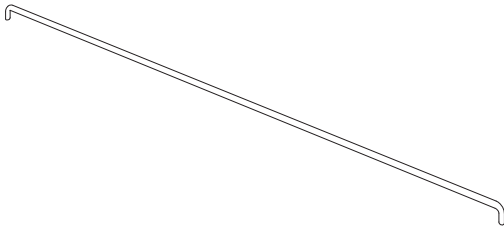

- These shelf rods to be used with Envision 3.5 shelves
- Anything above 48" wide will require a center bracket, which is included.

Cat. No.		Number of Rods	Width
Aluminum	Stainless Steel		
E3SRF-42	E3SRF-42S	1	38.875"
E3SRF-48	E3SRF-48S	1	44.875"
E3SRF-60	E3SRF-60S	2	27.875"
E3SRF-72	E3SRF-72S	2	33.875"

Envision 3.5 - Rear Shelf Rod

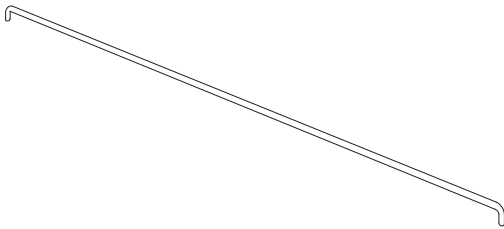

- These shelf rods to be used with Envision 3.5 shelves
- Anything above 48" wide will require a center bracket, which is included.

Cat. No.		Number of Rods	Width
Aluminum	Stainless Steel		
E3SRR-42	E3SRR-42S	1	36.75"
E3SRR-48	E3SRR-48S	1	42.75"
E3SRR-60	E3SRR-60S	2	25.75"
E3SRR-72	E3SRR-72S	2	31.75"

Envision 3.5 - Side Shelf Rod

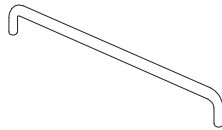

- These shelf rods to be used with Envision 3.5 shelves

Cat. No.		Number of Rods	Depth
Aluminum	Stainless Steel		
E3SRS-9	E3SRS-9S	1	7"
E3SRS-12	E3SRS-12S	1	10"
E3SRS-15	E3SRS-15S	1	13"

Wall Cabinet Hanger Bars

- Not available for Envision 3.5

Envision 3.5 - Cabinet Stop

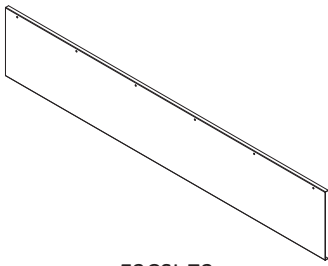

E3CSI-72

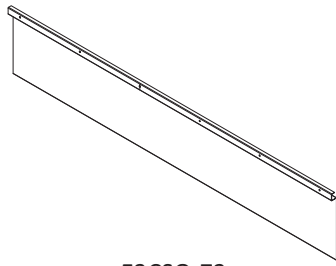

E3CSO-72

- These Cabinet Stops are to be used with Envision 3.5
- They are to prevent mobile cabinet from rolling to far under the work surface

Cat. No.		Actual Width	Width
For Inset Cabinet	For Overlay Cabinet		
E3CSI-42	E3CSO-42	34.75"	42"
E3CSI-48	E3CSO-48	40.75"	48"
E3CSI-60	E3CSO-60	52.75"	60"
E3CSI-72	E3CSO-72	64.75"	72"

Envision 3.5 - Stabilizer Bar

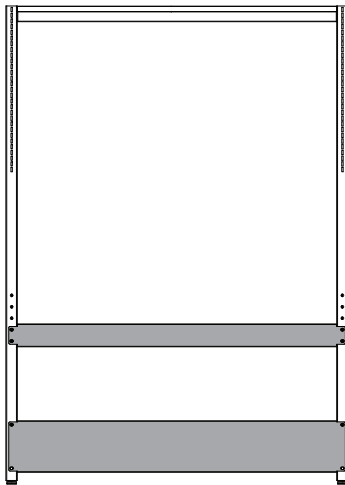

Elevation of Stabilizer Bars

- These Stabilizer Bars are to be used with Envision 3.5

Cat. No.		Width
Lower Brace	Upper Brace	
E3SBRL-42	E3SBRU-42	42"
E3SBRL-48	E3SBRU-48	48"
E3SBRL-60	E3SBRU-60	60"
E3SBRL-72	E3SBRU-72	72"

Envision 3.5 - Table Support Clamps



- These are to be used with Envision 3.5
- Kit of 2 with hardware
- Use for all tables on backside of 6" uprights

Cat. No.	Type
E3TSC	Table Support Clamps

Envision 3.5

LED Task Lighting for Envision 3.5

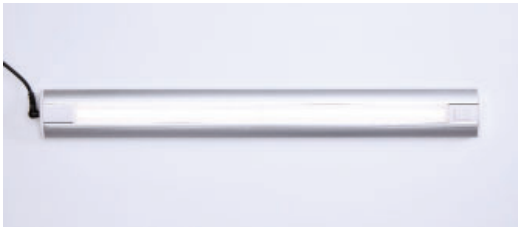

- Touch and hold continuous dimming and 10 hour automatic turnoff
- Units with (1) light include: (1) LED task light, magnetic angle mount that allows for up to 25° adjustment, 60 watt power supply with magnetic mount and 6' white cord
- Units with (2) lights include: (2) LED task light, magnetic angle mount that allows for up to 25° adjustment, 60 watt power supply with magnetic mount, 6' white cord, and 1 interlink cord to connect lights
- 60 watt power supply with magnetic mount and 6' white cord
- Made with anodized aluminum
- Lasts up to 50,000 hours

Cat. No.	Quantity of Lights	Actual Width	For use with:
Single Sided			
TL17-LED	1	17"	42" wide Table
TL17-LED	1	17"	48" wide Table
TL34-LED	2	17"	60" wide Table
TL34-LED	2	17"	72" wide Table
Double Sided			
TL17-LEDDBL	2	17"	42" wide Table
TL17-LEDDBL	2	17"	48" wide Table
TL34-LEDDBL	4	17"	60" wide Table
TL34-LEDDBL	4	17"	72" wide Table

Envision 3.5 Electrical for 6" upright

Sample: E35W6I $\frac{\quad}{1} \frac{\quad}{2} \frac{\quad}{3}$ - (width of upright)

Space 1 Options:

G = Grey
I = Ivory
W = White

Space 2 Options:

4 = 4' cord above upright
6 = 6' cord above upright

Space 3 Options:

(Blank) = Standard outlet
G = GFI outlet

Cat. No.	Description	Width Options
E35W6I ___ - ___	2 circuit, 1 plug, 6 electrical outlets	42", 48", 60", 72"
E35W6J ___ - ___	2 circuit, 2 plug, 6 electrical outlets	42", 48", 60", 72"
E35W6K ___ - ___	3 circuit, 2 plug, 6 electrical outlets	42", 48", 60", 72"
E35W6L ___ - ___	4 circuit, 2 plug, 6 electrical outlets	42", 48", 60", 72"

Example: E35W6IG4G-48

Envision 3.5 Wiring for 6" upright, Grey, 2 circuit, 1 plug, 6 GFI outlets, for 48" wide upright

Note: All electrical components are UL Labeled and pre-wiring is UL Listed

Envision 3.5 Data

Envision 3.5 Data for 6" upright

Sample: E35D6₁₂₃ - (width of upright)

Space 1 Options:

2 = Double Data
4 = Quad Data

Space 2 Options:

G = Light Grey

Space 3 Options:

4 = 4' cord above upright
6 = 6' cord above upright

Cat. No.	Description	Width Options
E35D6____-__	Double Data Outlet	42", 48", 60", 72"
E35D6____-__	Quad Data Outlet	42", 48", 60", 72"

Example: E35D62G4-48

Envision 3.5 Data for 6" upright, Light Grey, Double Data Outlet, for 48" wide upright

Note: Data is CAT-5E

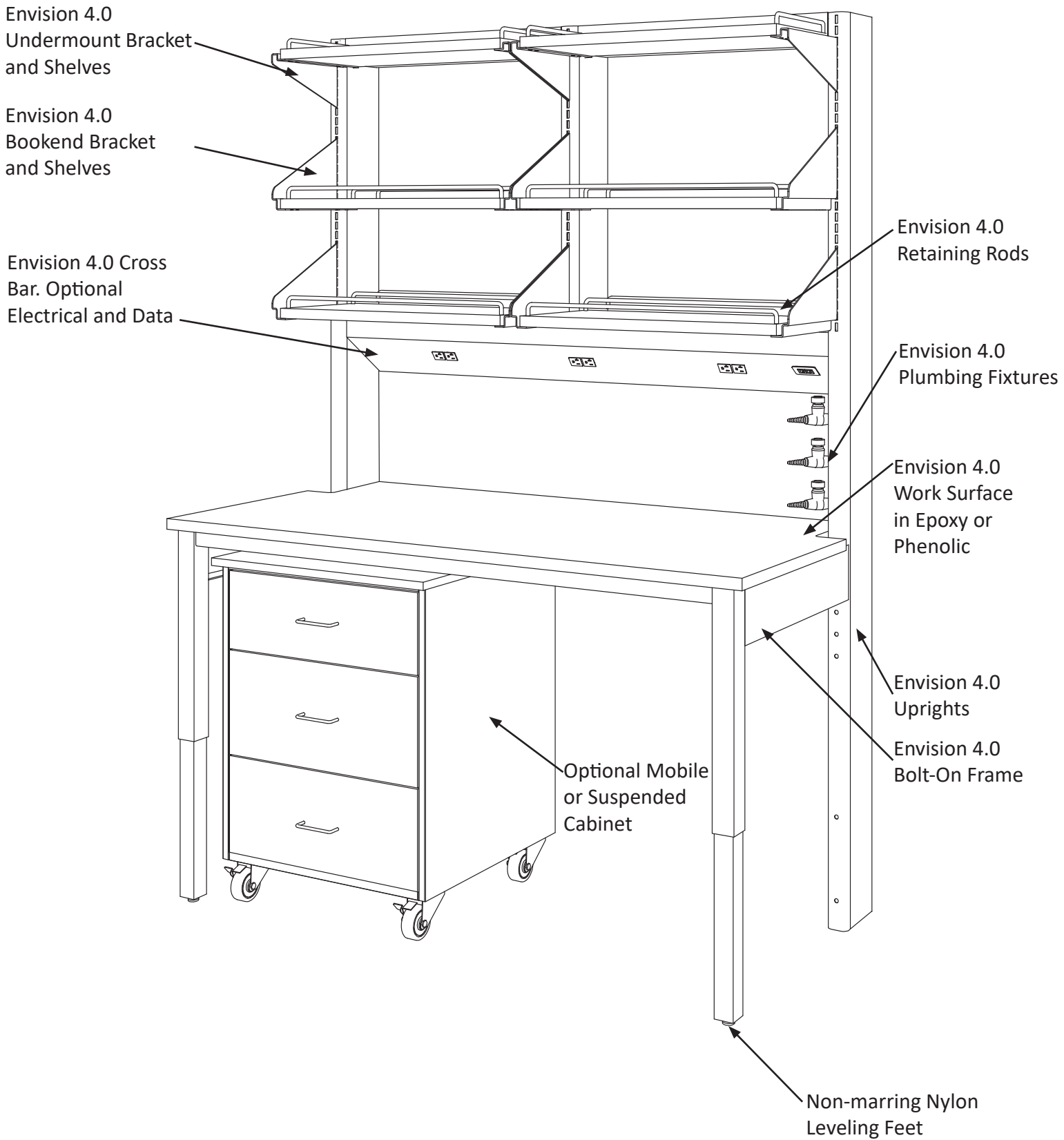

Envision 4.0

Envision 4.0 - 3" Uprights with Plumbing Cutouts Only

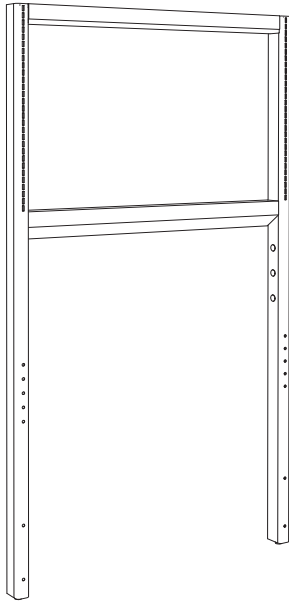

E4U3B-48R

- Uprights are 3" Deep Envision 4.0, Single Sided
- Heights is 84"
- Upright with a width greater than 48" has a center upright
- For Stainless Steel contact your ICI representative

Includes:

- (3) plumbing cutouts on the noted side

Cat. No.		Width
Left Hand Plumbing	Right Hand Plumbing	
E4U3B-42L	E4U3B-42R	42"
E4U3B-48L	E4U3B-48R	48"
E4U3B-60L	E4U3B-60R	60"
E4U3B-72L	E4U3B-72R	72"
E4U3B-84L	E4U3B-84R	84"
E4U3B-96L	E4U3B-96R	96"

Envision 4.0 - 3" Uprights with Plumbing and Data Cutouts Only

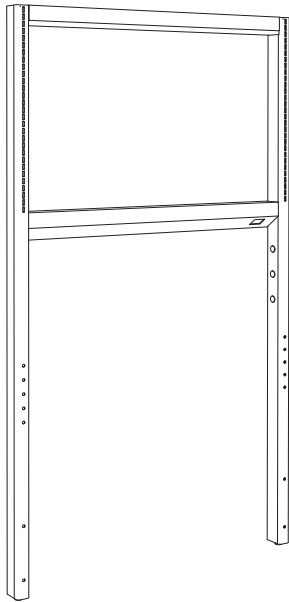

E4U3D-48R

- Uprights are 3" Deep Envision 4.0, Single Sided
- Heights is 84"
- Upright with a width greater than 48" has a center upright
- For Stainless Steel contact your ICI representative

Includes:

- (3) plumbing cutouts on the noted side
- (1) data cutout on cross bar on same side as plumbing cutouts

Cat. No.		Width
Left Hand Plumbing	Right Hand Plumbing	
E4U3D-42L	E4U3D-42R	42"
E4U3D-48L	E4U3D-48R	48"
E4U3D-60L	E4U3D-60R	60"
E4U3D-72L	E4U3D-72R	72"
E4U3D-84L	E4U3D-84R	84"
E4U3D-96L	E4U3D-96R	96"

Envision 4.0 - 3" Uprights with Plumbing, Data, and Standard Electric Cutouts Only

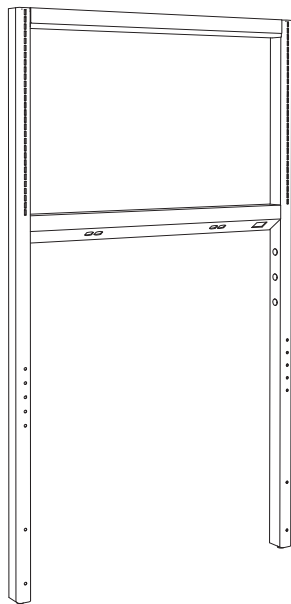

E4U3DE-48R

- Uprights are 3" Deep Envision 4.0, Single Sided
- Heights is 84"
- Upright with a width greater than 48" has a center upright
- For Stainless Steel contact your ICI representative

Includes:

- (3) plumbing cutouts on the noted side
- (1) data cutout on cross bar on same side as plumbing cutouts
- 42" - 48" wide uprights have (2) standard electric cutouts on cross bar
- 60" - 96" wide uprights have (3) standard electric cutouts on cross bar
- (1) standard electric cutout on post opposite plumbing

Cat. No.		Width
Left Hand Plumbing	Right Hand Plumbing	
E4U3DE-42L	E4U3DE-42R	42"
E4U3DE-48L	E4U3DE-48R	48"
E4U3DE-60L	E4U3DE-60R	60"
E4U3DE-72L	E4U3DE-72R	72"
E4U3DE-84L	E4U3DE-84R	84"
E4U3DE-96L	E4U3DE-96R	96"

Envision 4.0 - 3" Uprights with Plumbing, Data, and Standard & GFI Electric Cutouts Only

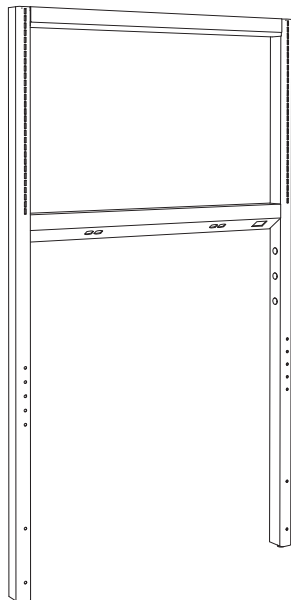

E4U3DEG-48R

- Uprights are 3" Deep Envision 4.0, Single Sided
- Heights is 84"
- Upright with a width greater than 48" has a center upright
- For Stainless Steel contact your ICI representative

Includes:

- (3) plumbing cutouts on the noted side
- (1) data cutout on cross bar on same side as plumbing cutouts
- 42" - 48" wide uprights have (2) standard electric cutouts on cross bar
- 60" - 96" wide uprights have (3) standard electric cutouts on cross bar
- (1) GFI electric cutout on post opposite plumbing

Cat. No.		Width
Left Hand Plumbing	Right Hand Plumbing	
E4U3DEG-42L	E4U3DEG-42R	42"
E4U3DEG-48L	E4U3DEG-48R	48"
E4U3DEG-60L	E4U3DEG-60R	60"
E4U3DEG-72L	E4U3DEG-72R	72"
E4U3DEG-84L	E4U3DEG-84R	84"
E4U3DEG-96L	E4U3DEG-96R	96"

Envision 4.0

Envision 4.0 - 3" Uprights with Plumbing, and Standard Electric Cutouts Only

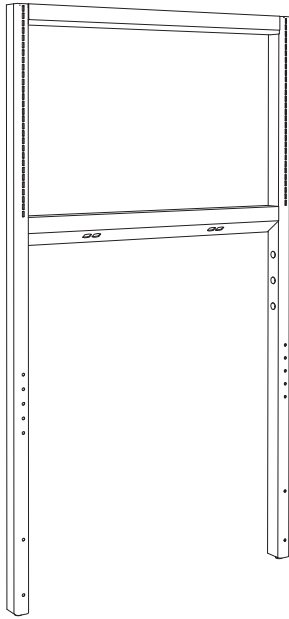

E4U3E-48R

- Uprights are 3" Deep Envision 4.0, Single Sided
- Heights is 84"
- Upright with a width greater than 48" has a center upright
- For Stainless Steel contact your ICI representative

Includes:

- (3) plumbing cutouts on the noted side
- 42" - 48" wide uprights have (2) standard electric cutouts on cross bar
- 60" - 96" wide uprights have (3) standard electric cutouts on cross bar
- (1) standard electric cutout on post opposite plumbing

Cat. No.		Width
Left Hand Plumbing	Right Hand Plumbing	
E4U3E-42L	E4U3E-42R	42"
E4U3E-48L	E4U3E-48R	48"
E4U3E-60L	E4U3E-60R	60"
E4U3E-72L	E4U3E-72R	72"
E4U3E-84L	E4U3E-84R	84"
E4U3E-96L	E4U3E-96R	96"

Envision 4.0 - 3" Uprights with Plumbing, and Standard & GFI Electric Cutouts Only

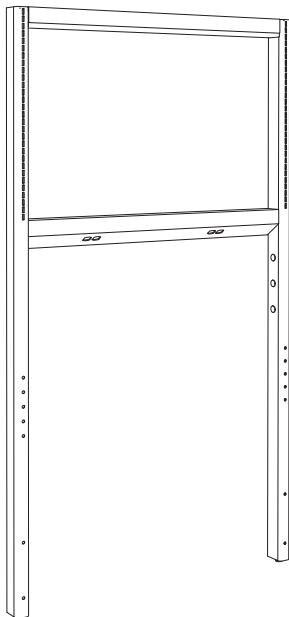

E3U3E-48R

- Uprights are 3" Deep Envision 4.0, Single Sided
- Heights is 84"
- Upright with a width greater than 48" has a center upright
- For Stainless Steel contact your ICI representative

Includes:

- (3) plumbing cutouts on the noted side
- 42" - 48" wide uprights have (2) standard electric cutouts on cross bar
- 60" - 96" wide uprights have (3) standard electric cutouts on cross bar
- (1) GFI electric cutout on post opposite plumbing

Cat. No.		Width
Left Hand Plumbing	Right Hand Plumbing	
E4U3EG-42L	E4U3EG-42R	42"
E4U3EG-48L	E4U3EG-48R	48"
E4U3EG-60L	E4U3EG-60R	60"
E4U3EG-72L	E4U3EG-72R	72"
E4U3EG-84L	E4U3EG-84R	84"
E4U3EG-96L	E4U3EG-96R	96"

Envision 4.0 - 6" Uprights with Plumbing Cutouts Only

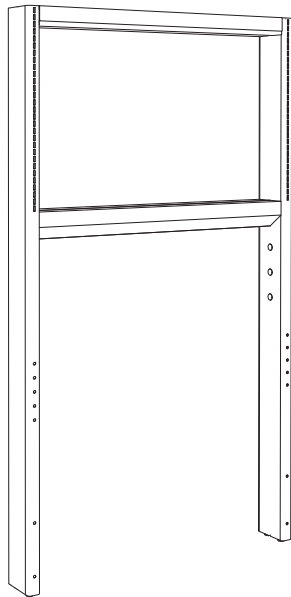

E4U6B-48

- Uprights are 6" Deep Envision 4.0, Double Sided
- Heights is 84"
- Upright with a width greater than 48" has a center upright
- For Stainless Steel contact your ICI representative

Includes:

- (3) plumbing cutouts on one side

Cat. No.	Width
E4U6B-42	42"
E4U6B-48	48"
E4U6B-60	60"
E4U6B-72	72"
E4U6B-84	84"
E4U6B-96	96"

Envision 4.0 - 6" Uprights with Plumbing, and Data Cutouts Only

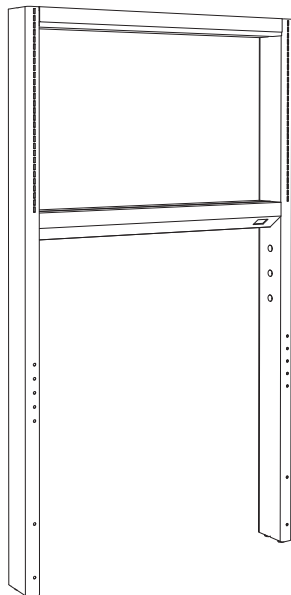

E4U6D-48

- Uprights are 6" Deep Envision 4.0, Double Sided
- Heights is 84"
- Upright with a width greater than 48" has a center upright
- For Stainless Steel contact your ICI representative

Includes:

- (3) plumbing cutouts on one side
- (1) data cutout on cross bar on same side as plumbing cutouts

Cat. No.	Width
E4U6D-42	42"
E4U6D-48	48"
E4U6D-60	60"
E4U6D-72	72"
E4U6D-84	84"
E4U6D-96	96"

Envision 4.0

Envision 4.0 - 6" Uprights with Plumbing, Data, and Standard Electric Cutouts Only

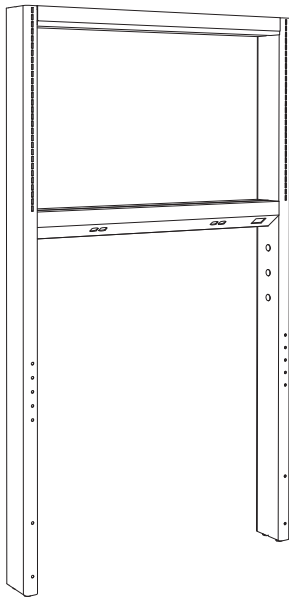

E4U6DE-48

- Uprights are 6" Deep Envision 4.0, Double Sided
- Heights is 84"
- Upright with a width greater than 48" has a center upright
- For Stainless Steel contact your ICI representative

Includes:

- (3) plumbing cutouts on one side
- (1) data cutout on cross bar on same side as plumbing cutouts
- 42" - 48" wide uprights have (4) standard electric cutouts on cross bar
- 60" - 96" wide uprights have (6) standard electric cutouts on cross bar
- (2) standard electric cutout on opposite post as the plumbing cutouts

Cat. No.	Width
E4U6DE-42	42"
E4U6DE-48	48"
E4U6DE-60	60"
E4U6DE-72	72"
E4U6DE-84	84"
E4U6DE-96	96"

Envision 4.0 - 6" Uprights with Plumbing, Data, and Standard & GFI Electric Cutouts Only

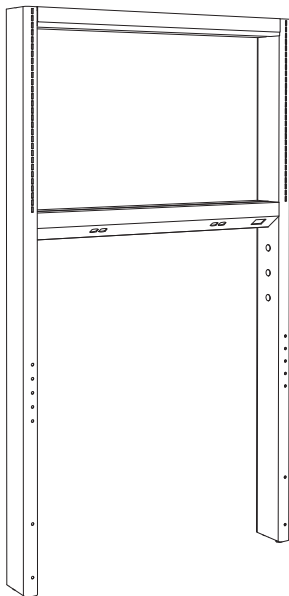

E4U6DEG-48

- Uprights are 6" Deep Envision 4.0, Double Sided
- Heights is 84"
- Upright with a width greater than 48" has a center upright
- For Stainless Steel contact your ICI representative

Includes:

- (3) plumbing cutouts on one side
- (1) data cutout on cross bar on same side as plumbing cutouts
- 42" - 48" wide uprights have (4) standard electric cutouts on cross bar
- 60" - 96" wide uprights have (6) standard electric cutouts on cross bar
- (2) GFI electric cutout on opposite post as the plumbing cutouts

Cat. No.	Width
E4U6DEG-42	42"
E4U6DEG-48	48"
E4U6DEG-60	60"
E4U6DEG-72	72"
E4U6DEG-84	84"
E4U6DEG-96	96"

Envision 4.0 - 6" Uprights with Plumbing, and Standard Electric Cutouts Only

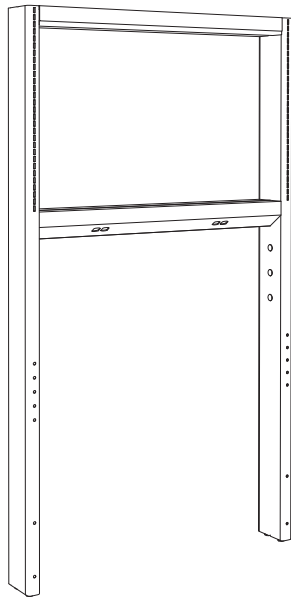

E4U6E-48

- Uprights are 6" Deep Envision 4.0, Double Sided
- Heights is 84"
- Upright with a width greater than 48" has a center upright
- For Stainless Steel contact your ICI representative

Includes:

- (3) plumbing cutouts on one side
- 42" - 48" wide uprights have (4) standard electric cutouts on cross bar
- 60" - 96" wide uprights have (6) standard electric cutouts on cross bar
- (2) standard electric cutout on opposite post as the plumbing cutouts

Cat. No.	Width
E4U6E-42	42"
E4U6E-48	48"
E4U6E-60	60"
E4U6E-72	72"
E4U6E-84	84"
E4U6E-96	96"

Envision 4.0 - 6" Uprights with Plumbing, and Standard & GFI Electric Cutouts Only

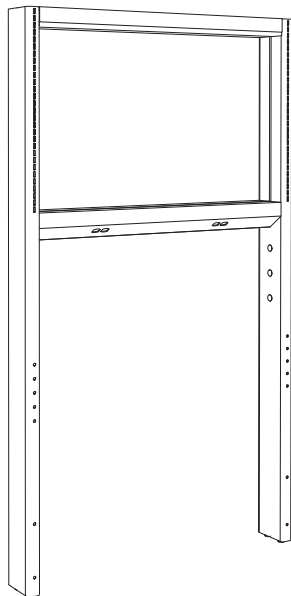

E4U6EG-48

- Uprights are 6" Deep Envision 4.0, Double Sided
- Heights is 84"
- Upright with a width greater than 48" has a center upright
- For Stainless Steel contact your ICI representative

Includes:

- (3) plumbing cutouts on one side
- 42" - 48" wide uprights have (4) standard electric cutouts on cross bar
- 60" - 96" wide uprights have (6) standard electric cutouts on cross bar
- (2) GFI electric cutout on opposite post as the plumbing cutouts

Cat. No.	Width
E4U6EG-42	42"
E4U6EG-48	48"
E4U6EG-60	60"
E4U6EG-72	72"
E4U6EG-84	84"
E4U6EG-96	96"

Envision 4.0

Envision 4.0 - Bolt-on Frame - 3" Upright Single Sided

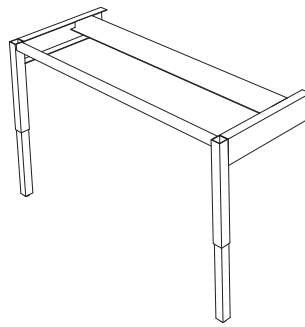
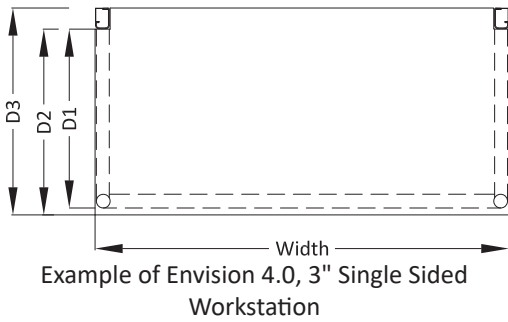

- Envision 4.0 Bolt-On Frames are to be attached to any Envision 4.0 uprights
- Only (1) Bolt-On Frame can be attached to a 3" upright
- (2) Bolt-On Frames can be attached to 6" uprights to make a double sided workstation
- Adjustable Height work surface frame from 30 1/4" - 36 1/4", in 2" increments
- For Stainless Steel, contact your ICI Representative
- Work Surface ordered separately
- Work Surface depth details listed below see page 72 for work surface part numbers

Bolt-on Frame Cat. No.	Depth of Bolt-on Frame (D1)	Nominal Depth of Bolt-on Frame (D2)	Depth of Work Surface with 3" Notch (D3)	Width
Nominal 21" Deep				
E4CTFB-2142	20"	21"	24"	42"
E4CTFB-2148	20"	21"	24"	48"
E4CTFB-2160	20"	21"	24"	60"
E4CTFB-2172	20"	21"	24"	72"
E4CTFB-2184	20"	21"	24"	84"
E4CTFB-2196	20"	21"	24"	96"
Nominal 24" Deep				
E4CTFB-2442	23"	24"	27"	42"
E4CTFB-2448	23"	24"	27"	48"
E4CTFB-2460	23"	24"	27"	60"
E4CTFB-2472	23"	24"	27"	72"
E4CTFB-2484	23"	24"	27"	84"
E4CTFB-2496	23"	24"	27"	96"
Nominal 27" Deep				
E4CTFB-2742	26"	27"	30"	42"
E4CTFB-2748	26"	27"	30"	48"
E4CTFB-2760	26"	27"	30"	60"
E4CTFB-2772	26"	27"	30"	72"
E4CTFB-2784	26"	27"	30"	84"
E4CTFB-2796	26"	27"	30"	96"
Nominal 30" Deep				
E4CTFB-3042	29"	30"	33"	42"
E4CTFB-3048	29"	30"	33"	48"
E4CTFB-3060	29"	30"	33"	60"
E4CTFB-3072	29"	30"	33"	72"
E4CTFB-3084	29"	30"	33"	84"
E4CTFB-3096	29"	30"	33"	96"
Nominal 33" Deep				
E4CTFB-3342	32"	33"	36"	42"
E4CTFB-3348	32"	33"	36"	48"
E4CTFB-3360	32"	33"	36"	60"
E4CTFB-3372	32"	33"	36"	72"
E4CTFB-3384	32"	33"	36"	84"
E4CTFB-3396	32"	33"	36"	96"

Envision 4.0 - Bolt-On and Table - 3" Uprights Double Sided

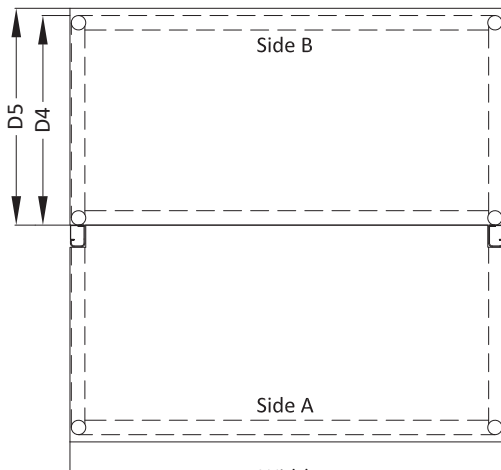

Example of Envision 4.0, 3" Upright Double Sided Workstation

- Envision 4.0 Tables are to be used to make a double sided workstation with a 3" or 6" upright
- Envision 4.0 Tables can also be free standing tables
- Adjustable Height work surface frame from 30 1/4" - 36 1/4", in 2" increments
- For Stainless Steel, contact your ICI Representative
- Work Surface ordered separately
- Work Surface depth details for Side A listed on previous page
- Work Surface depth details for Side B listed below see page 74 for work surface part numbers

Bolt-on Frame Cat. No.	Depth of Frame/Table (D4)	Depth of Work Surface with No Notch (D5)	Width	Bolt-on Frame Cat. No.	Depth of Frame/Table (D4)	Depth of Work Surface with No Notch (D5)	Width
Nominal 15" Deep				Nominal 27" Deep			
E4CTFT-1542	14"	15"	42"	E4CTFT-2742	26"	27"	42"
E4CTFT-1548	14"	15"	48"	E4CTFT-2748	26"	27"	48"
E4CTFT-1560	14"	15"	60"	E4CTFT-2760	26"	27"	60"
E4CTFT-1572	14"	15"	72"	E4CTFT-2772	26"	27"	72"
E4CTFT-1584	14"	15"	84"	E4CTFT-2784	26"	27"	84"
E4CTFT-1596	14"	15"	96"	E4CTFT-2796	26"	27"	96"
Nominal 18" Deep				Nominal 30" Deep			
E4CTFT-1842	17"	18"	42"	E4CTFT-3042	29"	30"	42"
E4CTFT-1848	17"	18"	48"	E4CTFT-3048	29"	30"	48"
E4CTFT-1860	17"	18"	60"	E4CTFT-3060	29"	30"	60"
E4CTFT-1872	17"	18"	72"	E4CTFT-3072	29"	30"	72"
E4CTFT-1884	17"	18"	84"	E4CTFT-3084	29"	30"	84"
E4CTFT-1896	17"	18"	96"	E4CTFT-3096	29"	30"	96"
Nominal 19" Deep				Nominal 33" Deep			
E4CTFT-1942	18"	19"	42"	E4CTFT-3342	32"	33"	42"
E4CTFT-1948	18"	19"	48"	E4CTFT-3348	32"	33"	48"
E4CTFT-1960	18"	19"	60"	E4CTFT-3360	32"	33"	60"
E4CTFT-1972	18"	19"	72"	E4CTFT-3372	32"	33"	72"
E4CTFT-1984	18"	19"	84"	E4CTFT-3384	32"	33"	84"
E4CTFT-1996	18"	19"	96"	E4CTFT-3396	32"	33"	96"
Nominal 21" Deep				Nominal 36" Deep			
E4CTFT-2142	20"	21"	42"	E4CTFT-3642	35"	36"	42"
E4CTFT-2148	20"	21"	48"	E4CTFT-3648	35"	36"	48"
E4CTFT-2160	20"	21"	60"	E4CTFT-3660	35"	36"	60"
E4CTFT-2172	20"	21"	72"	E4CTFT-3672	35"	36"	72"
E4CTFT-2184	20"	21"	84"	E4CTFT-3684	35"	36"	84"
E4CTFT-2196	20"	21"	96"	E4CTFT-3696	35"	36"	96"
Nominal 24" Deep							
E4CTFT-2442	23"	24"	42"				
E4CTFT-2448	23"	24"	48"				
E4CTFT-2460	23"	24"	60"				
E4CTFT-2472	23"	24"	72"				
E4CTFT-2484	23"	24"	84"				
E4CTFT-2496	23"	24"	96"				

Envision 4.0

Envision 4.0 - Bolt-On Frame - 6" Uprights Double Sided

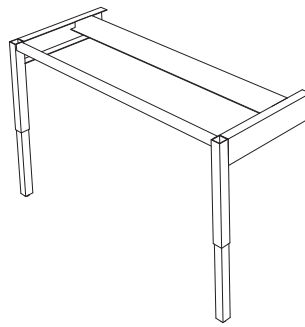
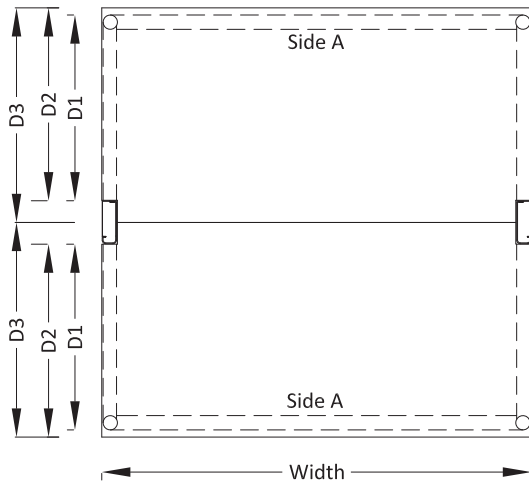

- Envision 4.0 Bolt-On Frames are to be attached to any Envision 4.0 uprights
- Only (1) Bolt-On Frame can be attached to a 3" upright
- (2) Bolt-On Frames can be attached to 6" uprights to make a double sided workstation
- Adjustable Height work surface frame from 30 1/4" - 36 1/4", in 2" increments
- For Stainless Steel, contact your ICI Representative
- Work Surface depth details for Side A listed below see page 72 for work surface part numbers

Example of Envision 4.0, 6" Upright Double Sided Workstation with (2) Bolt-on Frames

Bolt-on Frame Cat. No.	Depth of Bolt-on Frame (D1)	Nominal Depth of Bolt-on Frame (D2)	Depth of Work Surface with 3" Notch (D3)	Width
Nominal 21" Deep				
E4CTFB-2142	20"	21"	24"	42"
E4CTFB-2148	20"	21"	24"	48"
E4CTFB-2160	20"	21"	24"	60"
E4CTFB-2172	20"	21"	24"	72"
E4CTFB-2184	20"	21"	24"	84"
E4CTFB-2196	20"	21"	24"	96"
Nominal 24" Deep				
E4CTFB-2442	23"	24"	27"	42"
E4CTFB-2448	23"	24"	27"	48"
E4CTFB-2460	23"	24"	27"	60"
E4CTFB-2472	23"	24"	27"	72"
E4CTFB-2484	23"	24"	27"	84"
E4CTFB-2496	23"	24"	27"	96"
Nominal 27" Deep				
E4CTFB-2742	26"	27"	30"	42"
E4CTFB-2748	26"	27"	30"	48"
E4CTFB-2760	26"	27"	30"	60"
E4CTFB-2772	26"	27"	30"	72"
E4CTFB-2784	26"	27"	30"	84"
E4CTFB-2796	26"	27"	30"	96"
Nominal 30" Deep				
E4CTFB-3042	29"	30"	33"	42"
E4CTFB-3048	29"	30"	33"	48"
E4CTFB-3060	29"	30"	33"	60"
E4CTFB-3072	29"	30"	33"	72"
E4CTFB-3084	29"	30"	33"	84"
E4CTFB-3096	29"	30"	33"	96"

Envision 4.0 - Bolt-On and Frame/Table - 6" Uprights Double Sided

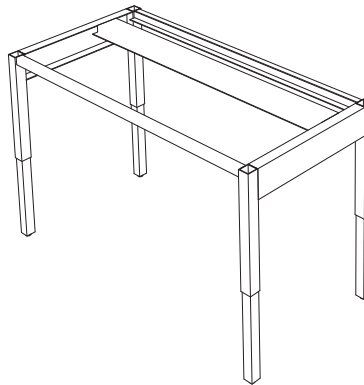
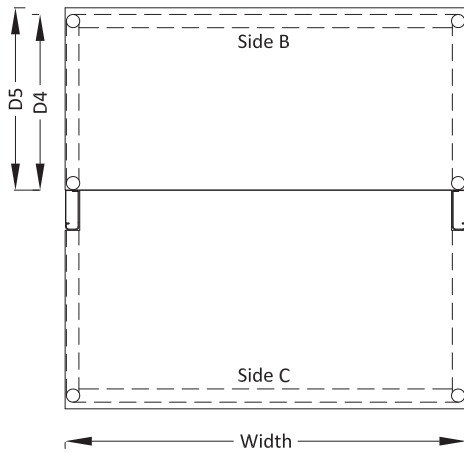

- Envision 4.0 Tables are to be used to make a double sided workstation with a 3" or 6" upright
- Envision 4.0 Tables can also be free standing tables
- Adjustable Height work surface frame from 30 1/4" - 36 1/4", in 2" increments
- For Stainless Steel, contact your ICI Representative
- Work Surface ordered separately
- Work Surface depth details for Side C listed on next page
- Work Surface depth details for Side B listed below see page 74 for work surface part numbers

Example of Envision 4.0, 6" Upright Double Sided Workstation with (1) Bolt-on and (1) Frame/Table

Bolt-on Frame Cat. No.	Depth of Frame/Table (D4)	Depth of Work Surface with No Notch (D5)	Width	Bolt-on Frame Cat. No.	Depth of Frame/Table (D4)	Depth of Work Surface with No Notch (D5)	Width
Nominal 15" Deep				Nominal 27" Deep			
E4CTFT-1542	14"	15"	42"	E4CTFT-2742	26"	27"	42"
E4CTFT-1548	14"	15"	48"	E4CTFT-2748	26"	27"	48"
E4CTFT-1560	14"	15"	60"	E4CTFT-2760	26"	27"	60"
E4CTFT-1572	14"	15"	72"	E4CTFT-2772	26"	27"	72"
E4CTFT-1584	14"	15"	84"	E4CTFT-2784	26"	27"	84"
E4CTFT-1596	14"	15"	96"	E4CTFT-2796	26"	27"	96"
Nominal 18" Deep				Nominal 30" Deep			
E4CTFT-1842	17"	18"	42"	E4CTFT-3042	29"	30"	42"
E4CTFT-1848	17"	18"	48"	E4CTFT-3048	29"	30"	48"
E4CTFT-1860	17"	18"	60"	E4CTFT-3060	29"	30"	60"
E4CTFT-1872	17"	18"	72"	E4CTFT-3072	29"	30"	72"
E4CTFT-1884	17"	18"	84"	E4CTFT-3084	29"	30"	84"
E4CTFT-1896	17"	18"	96"	E4CTFT-3096	29"	30"	96"
Nominal 19" Deep				Nominal 33" Deep			
E4CTFT-1942	18"	19"	42"	E4CTFT-3342	32"	33"	42"
E4CTFT-1948	18"	19"	48"	E4CTFT-3348	32"	33"	48"
E4CTFT-1960	18"	19"	60"	E4CTFT-3360	32"	33"	60"
E4CTFT-1972	18"	19"	72"	E4CTFT-3372	32"	33"	72"
E4CTFT-1984	18"	19"	84"	E4CTFT-3384	32"	33"	84"
E4CTFT-1996	18"	19"	96"	E4CTFT-3396	32"	33"	96"
Nominal 21" Deep				Nominal 36" Deep			
E4CTFT-2142	20"	21"	42"	E4CTFT-3642	35"	36"	42"
E4CTFT-2148	20"	21"	48"	E4CTFT-3648	35"	36"	48"
E4CTFT-2160	20"	21"	60"	E4CTFT-3660	35"	36"	60"
E4CTFT-2172	20"	21"	72"	E4CTFT-3672	35"	36"	72"
E4CTFT-2184	20"	21"	84"	E4CTFT-3684	35"	36"	84"
E4CTFT-2196	20"	21"	96"	E4CTFT-3696	35"	36"	96"
Nominal 24" Deep							
E4CTFT-2442	23"	24"	42"				
E4CTFT-2448	23"	24"	48"				
E4CTFT-2460	23"	24"	60"				
E4CTFT-2472	23"	24"	72"				
E4CTFT-2484	23"	24"	84"				
E4CTFT-2496	23"	24"	96"				

Envision 4.0

Envision 4.0 - Bolt-On and Table - 6" Uprights Double Sided

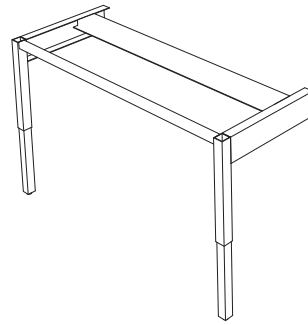
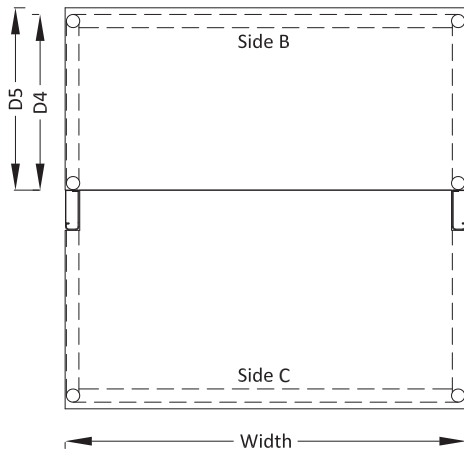

Example of Envision 3.0, 6" Upright Double Sided Workstation with (1) Bolt-on and (1) Table

- Envision 4.0 Tables are to be used to make a double sided workstation with a 3" or 6" upright
- Envision 4.0 Tables can also be free standing tables
- Adjustable Height work surface frame from 30 1/4" - 36 1/4", in 2" increments
- For Stainless Steel, contact your ICI Representative
- Work Surface ordered separately
- Work Surface depth details for Side B listed on previous page
- Work Surface depth details for Side C listed below see page 73 for work surface part numbers

Bolt-on Frame Cat. No.	Depth of Bolt-on Frame (D1)	Nominal Depth of Bolt-on Frame (D2)	Depth of Work Surface with 6" Notch (D3)	Width
Nominal 21" Deep				
E4CTFB-2142	20"	21"	27"	42"
E4CTFB-2148	20"	21"	27"	48"
E4CTFB-2160	20"	21"	27"	60"
E4CTFB-2172	20"	21"	27"	72"
E4CTFB-2184	20"	21"	27"	84"
E4CTFB-2196	20"	21"	27"	96"
Nominal 24" Deep				
E4CTFB-2442	23"	24"	30"	42"
E4CTFB-2448	23"	24"	30"	48"
E4CTFB-2460	23"	24"	30"	60"
E4CTFB-2472	23"	24"	30"	72"
E4CTFB-2484	23"	24"	30"	84"
E4CTFB-2496	23"	24"	30"	96"
Nominal 27" Deep				
E4CTFB-2742	26"	27"	33"	42"
E4CTFB-2748	26"	27"	33"	48"
E4CTFB-2760	26"	27"	33"	60"
E4CTFB-2772	26"	27"	33"	72"
E4CTFB-2784	26"	27"	33"	84"
E4CTFB-2796	26"	27"	33"	96"
Nominal 30" Deep				
E4CTFB-3042	29"	30"	36"	42"
E4CTFB-3048	29"	30"	36"	48"
E4CTFB-3060	29"	30"	36"	60"
E4CTFB-3072	29"	30"	36"	72"
E4CTFB-3084	29"	30"	36"	84"
E4CTFB-3096	29"	30"	36"	96"

Envision 4.0 - 3" Upright Notched Work Surface

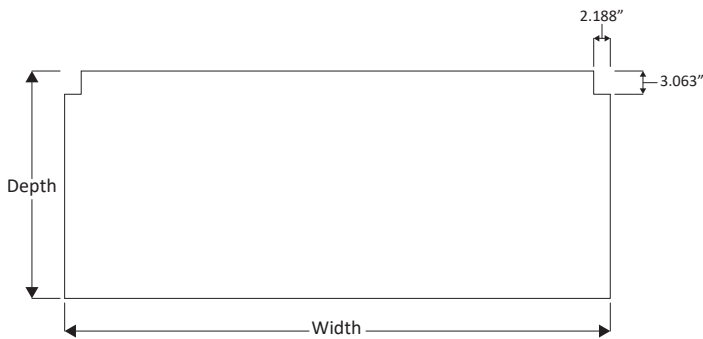

- This work surface is to be used with Envision 4.0, 3" upright

Epoxy	Cat. No. Phenolic	Stainless Steel	Width
24" Deep Top			
E4CT1ER3-2442	E4CT1PH3-2442	E4CT1SS3-2442	42"
E4CT1ER3-2448	E4CT1PH3-2448	E4CT1SS3-2448	48"
E4CT1ER3-2460	E4CT1PH3-2460	E4CT1SS3-2460	60"
E4CT1ER3-2472	E4CT1PH3-2472	E4CT1SS3-2472	72"
E4CT1ER3-2484	E4CT1PH3-2484	E4CT1SS3-2484	84"
E4CT1ER3-2496	E4CT1PH3-2496	E4CT1SS3-2496	96"
27" Deep Top			
E4CT1ER3-2742	E4CT1PH3-2742	E4CT1SS3-2742	42"
E4CT1ER3-2748	E4CT1PH3-2748	E4CT1SS3-2748	48"
E4CT1ER3-2760	E4CT1PH3-2760	E4CT1SS3-2760	60"
E4CT1ER3-2772	E4CT1PH3-2772	E4CT1SS3-2772	72"
E4CT1ER3-2784	E4CT1PH3-2784	E4CT1SS3-2784	84"
E4CT1ER3-2796	E4CT1PH3-2796	E4CT1SS3-2796	96"
30" Deep Top			
E4CT1ER3-3042	E4CT1PH3-3042	E4CT1SS3-3042	42"
E4CT1ER3-3048	E4CT1PH3-3048	E4CT1SS3-3048	48"
E4CT1ER3-3060	E4CT1PH3-3060	E4CT1SS3-3060	60"
E4CT1ER3-3072	E4CT1PH3-3072	E4CT1SS3-3072	72"
E4CT1ER3-3084	E4CT1PH3-3084	E4CT1SS3-3084	84"
E4CT1ER3-3096	E4CT1PH3-3096	E4CT1SS3-3096	96"
33" Deep Top			
E4CT1ER3-3342	E4CT1PH3-3342	E4CT1SS3-3342	42"
E4CT1ER3-3348	E4CT1PH3-3348	E4CT1SS3-3348	48"
E4CT1ER3-3360	E4CT1PH3-3360	E4CT1SS3-3360	60"
E4CT1ER3-3372	E4CT1PH3-3372	E4CT1SS3-3372	72"
E4CT1ER3-3384	E4CT1PH3-3384	E4CT1SS3-3384	84"
E4CT1ER3-3396	E4CT1PH3-3396	E4CT1SS3-3396	96"
36" Deep Top			
E4CT1ER3-3642	E4CT1PH3-3642	E4CT1SS3-3642	42"
E4CT1ER3-3648	E4CT1PH3-3648	E4CT1SS3-3648	48"
E4CT1ER3-3660	E4CT1PH3-3660	E4CT1SS3-3660	60"
E4CT1ER3-3672	E4CT1PH3-3672	E4CT1SS3-3672	72"
E4CT1ER3-3684	E4CT1PH3-3684	E4CT1SS3-3684	84"
E4CT1ER3-3696	E4CT1PH3-3696	E4CT1SS3-3696	96"

Envision 4.0

Envision 4.0 - 6" Upright Notched Work Surface

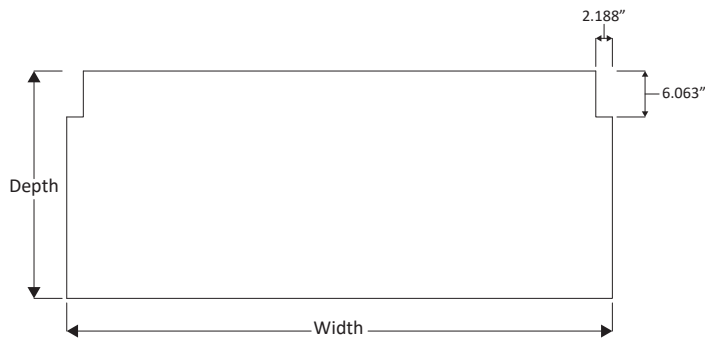

- This work surface is to be used with Envision 4.0, 6" upright

Epoxy	Cat. No. Phenolic	Stainless Steel	Width
27" Deep Top			
E4CT1ER6-2742	E4CT1PH6-2742	E4CT1SS6-2742	42"
E4CT1ER6-2748	E4CT1PH6-2748	E4CT1SS6-2748	48"
E4CT1ER6-2760	E4CT1PH6-2760	E4CT1SS6-2760	60"
E4CT1ER6-2772	E4CT1PH6-2772	E4CT1SS6-2772	72"
E4CT1ER6-2784	E4CT1PH6-2784	E4CT1SS6-2784	84"
E4CT1ER6-2796	E4CT1PH6-2796	E4CT1SS6-2796	96"
30" Deep Top			
E4CT1ER6-3042	E4CT1PH6-3042	E4CT1SS6-3042	42"
E4CT1ER6-3048	E4CT1PH6-3048	E4CT1SS6-3048	48"
E4CT1ER6-3060	E4CT1PH6-3060	E4CT1SS6-3060	60"
E4CT1ER6-3072	E4CT1PH6-3072	E4CT1SS6-3072	72"
E4CT1ER6-3084	E4CT1PH6-3084	E4CT1SS6-3084	84"
E4CT1ER6-3096	E4CT1PH6-3096	E4CT1SS6-3096	96"
33" Deep Top			
E4CT1ER6-3342	E4CT1PH6-3342	E4CT1SS6-3342	42"
E4CT1ER6-3348	E4CT1PH6-3348	E4CT1SS6-3348	48"
E4CT1ER6-3360	E4CT1PH6-3360	E4CT1SS6-3360	60"
E4CT1ER6-3372	E4CT1PH6-3372	E4CT1SS6-3372	72"
E4CT1ER6-3384	E4CT1PH6-3384	E4CT1SS6-3384	84"
E4CT1ER6-3396	E4CT1PH6-3396	E4CT1SS6-3396	96"
36" Deep Top			
E4CT1ER6-3642	E4CT1PH6-3642	E4CT1SS6-3642	42"
E4CT1ER6-3648	E4CT1PH6-3648	E4CT1SS6-3648	48"
E4CT1ER6-3660	E4CT1PH6-3660	E4CT1SS6-3660	60"
E4CT1ER6-3672	E4CT1PH6-3672	E4CT1SS6-3672	72"
E4CT1ER6-3684	E4CT1PH6-3684	E4CT1SS6-3684	84"
E4CT1ER6-3696	E4CT1PH6-3696	E4CT1SS6-3696	96"

Envision 4.0 - No Notch Work Surface

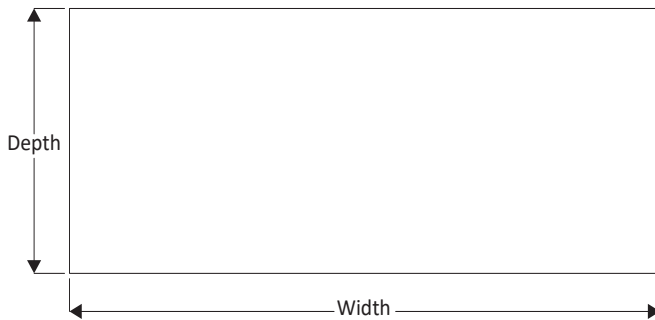

- This work surface is to be used with an Envision 4.0 Table

15" Deep Top				27" Deep Top			
Epoxy	Cat. No. Phenolic	Stainless Steel	Width	Epoxy	Cat. No. Phenolic	Stainless Steel	Width
E4CT1ERT-1542	E4CT1PHT-1542	E4CT1SST-1542	42"	E4CT1ERT-2742	E4CT1PHT-2742	E4CT1SST-2742	42"
E4CT1ERT-1548	E4CT1PHT-1548	E4CT1SST-1548	48"	E4CT1ERT-2748	E4CT1PHT-2748	E4CT1SST-2748	48"
E4CT1ERT-1560	E4CT1PHT-1560	E4CT1SST-1560	60"	E4CT1ERT-2760	E4CT1PHT-2760	E4CT1SST-2760	60"
E4CT1ERT-1572	E4CT1PHT-1572	E4CT1SST-1572	72"	E4CT1ERT-2772	E4CT1PHT-2772	E4CT1SST-2772	72"
E4CT1ERT-1584	E4CT1PHT-1584	E4CT1SST-1584	84"	E4CT1ERT-2784	E4CT1PHT-2784	E4CT1SST-2784	84"
E4CT1ERT-1596	E4CT1PHT-1596	E4CT1SST-1596	96"	E4CT1ERT-2796	E4CT1PHT-2796	E4CT1SST-2796	96"
18" Deep Top				30" Deep Top			
E4CT1ERT-1842	E4CT1PHT-1842	E4CT1SST-1842	42"	E4CT1ERT-3042	E4CT1PHT-3042	E4CT1SST-3042	42"
E4CT1ERT-1848	E4CT1PHT-1848	E4CT1SST-1848	48"	E4CT1ERT-3048	E4CT1PHT-3048	E4CT1SST-3048	48"
E4CT1ERT-1860	E4CT1PHT-1860	E4CT1SST-1860	60"	E4CT1ERT-3060	E4CT1PHT-3060	E4CT1SST-3060	60"
E4CT1ERT-1872	E4CT1PHT-1872	E4CT1SST-1872	72"	E4CT1ERT-3072	E4CT1PHT-3072	E4CT1SST-3072	72"
E4CT1ERT-1884	E4CT1PHT-1884	E4CT1SST-1884	84"	E4CT1ERT-3084	E4CT1PHT-3084	E4CT1SST-3084	84"
E4CT1ERT-1896	E4CT1PHT-1896	E4CT1SST-1896	96"	E4CT1ERT-3096	E4CT1PHT-3096	E4CT1SST-3096	96"
19" Deep Top				33" Deep Top			
E4CT1ERT-1942	E4CT1PHT-1942	E4CT1SST-1942	42"	E4CT1ERT-3342	E4CT1PHT-3342	E4CT1SST-3342	42"
E4CT1ERT-1948	E4CT1PHT-1948	E4CT1SST-1948	48"	E4CT1ERT-3348	E4CT1PHT-3348	E4CT1SST-3348	48"
E4CT1ERT-1960	E4CT1PHT-1960	E4CT1SST-1960	60"	E4CT1ERT-3360	E4CT1PHT-3360	E4CT1SST-3360	60"
E4CT1ERT-1972	E4CT1PHT-1972	E4CT1SST-1972	72"	E4CT1ERT-3372	E4CT1PHT-3372	E4CT1SST-3372	72"
E4CT1ERT-1984	E4CT1PHT-1984	E4CT1SST-1984	84"	E4CT1ERT-3384	E4CT1PHT-3384	E4CT1SST-3384	84"
E4CT1ERT-1996	E4CT1PHT-1996	E4CT1SST-1996	96"	E4CT1ERT-3396	E4CT1PHT-3396	E4CT1SST-3396	96"
21" Deep Top				36" Deep Top			
E4CT1ERT-2142	E4CT1PHT-2142	E4CT1SST-2142	42"	E4CT1ERT-3642	E4CT1PHT-3642	E4CT1SST-3642	42"
E4CT1ERT-2148	E4CT1PHT-2148	E4CT1SST-2148	48"	E4CT1ERT-3648	E4CT1PHT-3648	E4CT1SST-3648	48"
E4CT1ERT-2160	E4CT1PHT-2160	E4CT1SST-2160	60"	E4CT1ERT-3660	E4CT1PHT-3660	E4CT1SST-3660	60"
E4CT1ERT-2172	E4CT1PHT-2172	E4CT1SST-2172	72"	E4CT1ERT-3672	E4CT1PHT-3672	E4CT1SST-3672	72"
E4CT1ERT-2184	E4CT1PHT-2184	E4CT1SST-2184	84"	E4CT1ERT-3684	E4CT1PHT-3684	E4CT1SST-3684	84"
E4CT1ERT-2196	E4CT1PHT-2196	E4CT1SST-2196	96"	E4CT1ERT-3696	E4CT1PHT-3696	E4CT1SST-3696	96"
24" Deep Top							
E4CT1ERT-2442	E4CT1PHT-2442	E4CT1SST-2442	42"				
E4CT1ERT-2448	E4CT1PHT-2448	E4CT1SST-2448	48"				
E4CT1ERT-2460	E4CT1PHT-2460	E4CT1SST-2460	60"				
E4CT1ERT-2472	E4CT1PHT-2472	E4CT1SST-2472	72"				
E4CT1ERT-2484	E4CT1PHT-2484	E4CT1SST-2484	84"				
E4CT1ERT-2496	E4CT1PHT-2496	E4CT1SST-2496	96"				

Envision 4.0

Envision 4.0 - .75" Thick Shelving - No Rear Rod Cutout

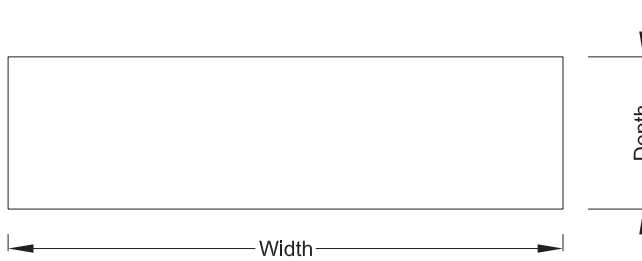

- These shelves to be used with Envision 4.0 brackets
- Each part number includes (1) shelf. If purchasing shelves for 60" uprights or wider you must order (2) shelves

Epoxy	Cat. No.		Stainless Steel	Wood - Maple	Wood - Oak	Actual Width	For Use With:
	Phenolic	Painted Steel					
9.5" Deep							
E4S75ER-9542	E4S75PH-9542	E4S75MS-9542	E4S75SS-9542	E4S75WM-9542	E4S75WO-9542	37.75"	42" Wide Upright
E4S75ER-9548	E4S75PH-9548	E4S75MS-9548	E4S75SS-9548	E4S75WM-9548	E4S75WO-9548	43.75"	48" Wide Upright
E4S75ER-9560	E4S75PH-9560	E4S75MS-9560	E4S75SS-9560	E4S75WM-9560	E4S75WO-9560	26.75"	60" Wide Upright
E4S75ER-9572	E4S75PH-9572	E4S75MS-9572	E4S75SS-9572	E4S75WM-9572	E4S75WO-9572	32.75"	72" Wide Upright
E4S75ER-9584	E4S75PH-9584	E4S75MS-9584	E4S75SS-9584	E4S75WM-9584	E4S75WO-9584	38.75"	84" Wide Upright
E4S75ER-9596	E4S75PH-9596	E4S75MS-9596	E4S75SS-9596	E4S75WM-9596	E4S75WO-9596	44.75"	96" Wide Upright
12" Deep							
E3S75ER-1242	E3S75PH-1242	E3S75MS-1242	E3S75SS-1242	E4S75WM-1242	E4S75WO-1242	37.75"	42" Wide Upright
E3S75ER-1248	E3S75PH-1248	E3S75MS-1248	E3S75SS-1248	E4S75WM-1248	E4S75WO-1248	43.75"	48" Wide Upright
E3S75ER-1260	E3S75PH-1260	E3S75MS-1260	E3S75SS-1260	E4S75WM-1260	E4S75WO-1260	26.75"	60" Wide Upright
E3S75ER-1272	E3S75PH-1272	E3S75MS-1272	E3S75SS-1272	E4S75WM-1272	E4S75WO-1272	32.75"	72" Wide Upright
E3S75ER-1284	E3S75PH-1284	E3S75MS-1284	E3S75SS-1284	E4S75WM-1284	E4S75WO-1284	38.75"	84" Wide Upright
E3S75ER-1296	E3S75PH-1296	E3S75MS-1296	E3S75SS-1296	E4S75WM-1296	E4S75WO-1296	44.75"	96" Wide Upright
13" Deep							
E4S75ER-1342	E4S75PH-1342	E4S75MS-1342	E4S75SS-1342	E4S75WM-1342	E4S75WO-1342	37.75"	42" Wide Upright
E4S75ER-1348	E4S75PH-1348	E4S75MS-1348	E4S75SS-1348	E4S75WM-1348	E4S75WO-1348	43.75"	48" Wide Upright
E4S75ER-1360	E4S75PH-1360	E4S75MS-1360	E4S75SS-1360	E4S75WM-1360	E4S75WO-1360	26.75"	60" Wide Upright
E4S75ER-1372	E4S75PH-1372	E4S75MS-1372	E4S75SS-1372	E4S75WM-1372	E4S75WO-1372	32.75"	72" Wide Upright
E4S75ER-1384	E4S75PH-1384	E4S75MS-1384	E4S75SS-1384	E4S75WM-1384	E4S75WO-1384	38.75"	84" Wide Upright
E4S75ER-1396	E4S75PH-1396	E4S75MS-1396	E4S75SS-1396	E4S75WM-1396	E4S75WO-1396	44.75"	96" Wide Upright
15" Deep							
E4S75ER-1542	E4S75PH-1542	E4S75MS-1542	E4S75SS-1542	E4S75WM-1542	E4S75WO-1542	37.75"	42" Wide Upright
E4S75ER-1548	E4S75PH-1548	E4S75MS-1548	E4S75SS-1548	E4S75WM-1548	E4S75WO-1548	43.75"	48" Wide Upright
E4S75ER-1560	E4S75PH-1560	E4S75MS-1560	E4S75SS-1560	E4S75WM-1560	E4S75WO-1560	26.75"	60" Wide Upright
E4S75ER-1572	E4S75PH-1572	E4S75MS-1572	E4S75SS-1572	E4S75WM-1572	E4S75WO-1572	32.75"	72" Wide Upright
E4S75ER-1584	E4S75PH-1584	E4S75MS-1584	E4S75SS-1584	E4S75WM-1584	E4S75WO-1584	38.75"	84" Wide Upright
E4S75ER-1596	E4S75PH-1596	E4S75MS-1596	E4S75SS-1596	E4S75WM-1596	E4S75WO-1596	44.75"	96" Wide Upright
16" Deep							
E4S75ER-1642	E4S75PH-1642	E4S75MS-1642	E4S75SS-1642	E4S75WM-1642	E4S75WO-1642	37.75"	42" Wide Upright
E4S75ER-1648	E4S75PH-1648	E4S75MS-1648	E4S75SS-1648	E4S75WM-1648	E4S75WO-1648	43.75"	48" Wide Upright
E4S75ER-1660	E4S75PH-1660	E4S75MS-1660	E4S75SS-1660	E4S75WM-1660	E3S75WO-1660	26.75"	60" Wide Upright
E4S75ER-1672	E4S75PH-1672	E4S75MS-1672	E4S75SS-1672	E4S75WM-1672	E4S75WO-1672	32.75"	72" Wide Upright
E4S75ER-1684	E4S75PH-1684	E4S75MS-1684	E4S75SS-1684	E4S75WM-1684	E4S75WO-1684	38.75"	84" Wide Upright
E4S75ER-1696	E4S75PH-1696	E4S75MS-1696	E4S75SS-1696	E4S75WM-1696	E4S75WO-1696	44.75"	96" Wide Upright
18" Deep							
E4S75ER-1842	E4S75PH-1842	E4S75MS-1842	E4S75SS-1842	E4S75WM-1842	E4S75WO-1842	37.75"	42" Wide Upright
E4S75ER-1848	E4S75PH-1848	E4S75MS-1848	E4S75SS-1848	E4S75WM-1848	E4S75WO-1848	43.75"	48" Wide Upright
E4S75ER-1860	E4S75PH-1860	E4S75MS-1860	E4S75SS-1860	E4S75WM-1860	E4S75WO-1860	26.75"	60" Wide Upright
E4S75ER-1872	E4S75PH-1872	E4S75MS-1872	E4S75SS-1872	E4S75WM-1872	E4S75WO-1872	32.75"	72" Wide Upright
E4S75ER-1884	E4S75PH-1884	E4S75MS-1884	E4S75SS-1884	E4S75WM-1884	E4S75WO-1884	38.75"	84" Wide Upright
E4S75ER-1896	E4S75PH-1896	E4S75MS-1896	E4S75SS-1896	E4S75WM-1896	E4S75WO-1896	44.75"	96" Wide Upright

Envision 4.0 - 1" Thick Shelving - No Rear Rod Cutout

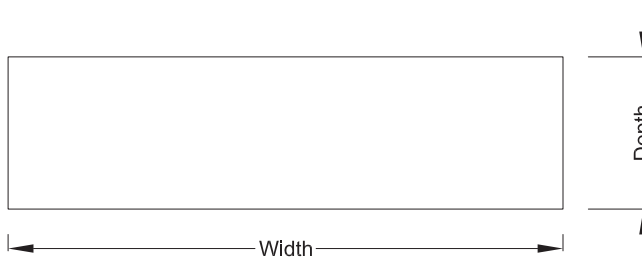

- These shelves to be used with Envision 4.0 brackets
- Each part number includes (1) shelf. If purchasing shelves for 60" uprights or wider you must order (2) shelves

Epoxy	Cat. No.		Painted Steel	Stainless Steel	Wood - Maple	Wood - Oak	Actual Width	For Use With:
	Phenolic							
9.5" Deep								
E4S1ER-9542	E4S1PH-9542	E4S1MS-9542	E4S1MS-9542	E4S1SS-9542	E4S1WM-9542	E4S1WO-9542	37.75"	42" Wide Upright
E4S1ER-9548	E4S1PH-9548	E4S1MS-9548	E4S1MS-9548	E4S1SS-9548	E4S1WM-9548	E4S1WO-9548	43.75"	48" Wide Upright
E4S1ER-9560	E4S1PH-9560	E4S1MS-9560	E4S1MS-9560	E4S1SS-9560	E4S1WM-9560	E4S1WO-9560	26.75"	60" Wide Upright
E4S1ER-9572	E4S1PH-9572	E4S1MS-9572	E4S1MS-9572	E4S1SS-9572	E4S1WM-9572	E4S1WO-9572	32.75"	72" Wide Upright
E4S1ER-9584	E4S1PH-9584	E4S1MS-9584	E4S1MS-9584	E4S1SS-9584	E4S1WM-9584	E4S1WO-9584	38.75"	84" Wide Upright
E4S1ER-9596	E4S1PH-9596	E4S1MS-9596	E4S1MS-9596	E4S1SS-9596	E4S1WM-9596	E4S1WO-9596	44.75"	96" Wide Upright
12" Deep								
E4S1ER-1242	E4S1PH-1242	E4S1MS-1242	E4S1MS-1242	E4S1SS-1242	E4S1WM-1242	E4S1WO-1242	37.75"	42" Wide Upright
E4S1ER-1248	E4S1PH-1248	E4S1MS-1248	E4S1MS-1248	E4S1SS-1248	E4S1WM-1248	E4S1WO-1248	43.75"	48" Wide Upright
E4S1ER-1260	E4S1PH-1260	E4S1MS-1260	E4S1MS-1260	E4S1SS-1260	E4S1WM-1260	E4S1WO-1260	26.75"	60" Wide Upright
E4S1ER-1272	E4S1PH-1272	E4S1MS-1272	E4S1MS-1272	E4S1SS-1272	E4S1WM-1272	E4S1WO-1272	32.75"	72" Wide Upright
E4S1ER-1284	E4S1PH-1284	E4S1MS-1284	E4S1MS-1284	E4S1SS-1284	E4S1WM-1284	E4S1WO-1284	38.75"	84" Wide Upright
E4S1ER-1296	E4S1PH-1296	E4S1MS-1296	E4S1MS-1296	E4S1SS-1296	E4S1WM-1296	E4S1WO-1296	44.75"	96" Wide Upright
13" Deep								
E4S1ER-1342	E4S1PH-1342	E4S1MS-1342	E4S1MS-1342	E4S1SS-1342	E4S1WM-1342	E4S1WO-1342	37.75"	42" Wide Upright
E4S1ER-1348	E4S1PH-1348	E4S1MS-1348	E4S1MS-1348	E4S1SS-1348	E4S1WM-1348	E4S1WO-1348	43.75"	48" Wide Upright
E4S1ER-1360	E4S1PH-1360	E4S1MS-1360	E4S1MS-1360	E4S1SS-1360	E4S1WM-1360	E4S1WO-1360	26.75"	60" Wide Upright
E4S1ER-1372	E4S1PH-1372	E4S1MS-1372	E4S1MS-1372	E4S1SS-1372	E4S1WM-1372	E4S1WO-1372	32.75"	72" Wide Upright
E4S1ER-1384	E4S1PH-1384	E4S1MS-1384	E4S1MS-1384	E4S1SS-1384	E4S1WM-1384	E4S1WO-1384	38.75"	84" Wide Upright
E4S1ER-1396	E4S1PH-1396	E4S1MS-1396	E4S1MS-1396	E4S1SS-1396	E4S1WM-1396	E4S1WO-1396	44.75"	96" Wide Upright
15" Deep								
E4S1ER-1542	E4S1PH-1542	E4S1MS-1542	E4S1MS-1542	E4S1SS-1542	E4S1WM-1542	E4S1WO-1542	37.75"	42" Wide Upright
E4S1ER-1548	E4S1PH-1548	E4S1MS-1548	E4S1MS-1548	E4S1SS-1548	E4S1WM-1548	E4S1WO-1548	43.75"	48" Wide Upright
E4S1ER-1560	E4S1PH-1560	E4S1MS-1560	E4S1MS-1560	E4S1SS-1560	E4S1WM-1560	E4S1WO-1560	26.75"	60" Wide Upright
E4S1ER-1572	E4S1PH-1572	E4S1MS-1572	E4S1MS-1572	E4S1SS-1572	E4S1WM-1572	E4S1WO-1572	32.75"	72" Wide Upright
E4S1ER-1584	E4S1PH-1584	E4S1MS-1584	E4S1MS-1584	E4S1SS-1584	E4S1WM-1584	E4S1WO-1584	38.75"	84" Wide Upright
E4S1ER-1596	E4S1PH-1596	E4S1MS-1596	E4S1MS-1596	E4S1SS-1596	E4S1WM-1596	E4S1WO-1596	44.75"	96" Wide Upright
16" Deep								
E4S1ER-1642	E4S1PH-1642	E4S1MS-1642	E4S1MS-1642	E4S1SS-1642	E4S1WM-1642	E4S1WO-1642	37.75"	42" Wide Upright
E4S1ER-1648	E4S1PH-1648	E4S1MS-1648	E4S1MS-1648	E4S1SS-1648	E4S1WM-1648	E4S1WO-1648	43.75"	48" Wide Upright
E4S1ER-1660	E4S1PH-1660	E4S1MS-1660	E4S1MS-1660	E4S1SS-1660	E4S1WM-1660	E4S1WO-1660	26.75"	60" Wide Upright
E4S1ER-1672	E4S1PH-1672	E4S1MS-1672	E4S1MS-1672	E4S1SS-1672	E4S1WM-1672	E4S1WO-1672	32.75"	72" Wide Upright
E4S1ER-1684	E4S1PH-1684	E4S1MS-1684	E4S1MS-1684	E4S1SS-1684	E4S1WM-1684	E4S1WO-1684	38.75"	84" Wide Upright
E4S1ER-1696	E4S1PH-1696	E4S1MS-1696	E4S1MS-1696	E4S1SS-1696	E4S1WM-1696	E4S1WO-1696	44.75"	96" Wide Upright
18" Deep								
E4S1ER-1842	E4S1PH-1842	E4S1MS-1842	E4S1MS-1842	E4S1SS-1842	E4S1WM-1842	E4S1WO-1842	37.75"	42" Wide Upright
E4S1ER-1848	E4S1PH-1848	E4S1MS-1848	E4S1MS-1848	E4S1SS-1848	E4S1WM-1848	E4S1WO-1848	43.75"	48" Wide Upright
E4S1ER-1860	E4S1PH-1860	E4S1MS-1860	E4S1MS-1860	E4S1SS-1860	E4S1WM-1860	E4S1WO-1860	26.75"	60" Wide Upright
E4S1ER-1872	E4S1PH-1872	E4S1MS-1872	E4S1MS-1872	E4S1SS-1872	E4S1WM-1872	E4S1WO-1872	32.75"	72" Wide Upright
E4S1ER-1884	E4S1PH-1884	E4S1MS-1884	E4S1MS-1884	E4S1SS-1884	E4S1WM-1884	E4S1WO-1884	38.75"	84" Wide Upright
E4S1ER-1896	E4S1PH-1896	E4S1MS-1896	E4S1MS-1896	E4S1SS-1896	E4S1WM-1896	E4S1WO-1896	44.75"	96" Wide Upright

Envision 4.0

Envision 4.0 - .75" Thick Shelving with Cutouts for Rear Rod

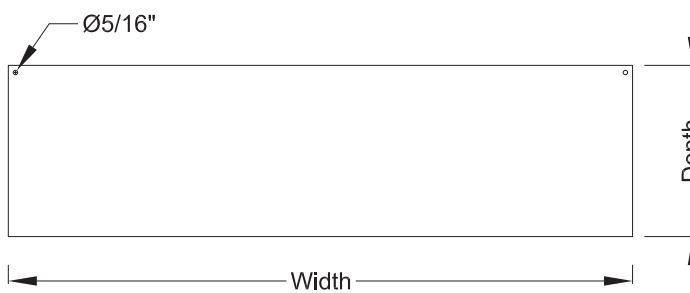

- These shelves to be used with Envision 4.0 brackets
- Each part number includes (1) shelf. If purchasing shelves for 60" uprights or wider you must order (2) shelves
- These shelves include cutouts for rear rod

Epoxy	Cat. No.		Painted Steel	Stainless Steel	Wood - Maple	Wood - Oak	Actual Width	For Use With:
	Phenolic							
9.5" Deep								
E4S75ERR-9542	E4S75PHR-9542	E4S75MSR-9542	E4S75SSR-9542	E4S75WMR-9542	E4S75WOR-9542	37.75"	42" Wide Upright	
E4S75ERR-9548	E4S75PHR-9548	E4S75MSR-9548	E4S75SSR-9548	E4S75WMR-9548	E4S75WOR-9548	43.75"	48" Wide Upright	
E4S75ERR-9560	E4S75PHR-9560	E4S75MSR-9560	E4S75SSR-9560	E4S75WMR-9560	E4S75WOR-9560	26.75"	60" Wide Upright	
E4S75ERR-9572	E4S75PHR-9572	E4S75MSR-9572	E4S75SSR-9572	E4S75WMR-9572	E4S75WOR-9572	32.75"	72" Wide Upright	
E4S75ERR-9584	E4S75PHR-9584	E4S75MSR-9584	E4S75SSR-9584	E4S75WMR-9584	E4S75WOR-9584	38.75"	84" Wide Upright	
E4S75ERR-9596	E4S75PHR-9596	E4S75MSR-9596	E4S75SSR-9596	E4S75WMR-9596	E4S75WOR-9596	44.75"	96" Wide Upright	
12" Deep								
E4S75ERR-1242	E4S75PHR-1242	E4S75MSR-1242	E4S75SSR-1242	E4S75WMR-1242	E4S75WOR-1242	37.75"	42" Wide Upright	
E4S75ERR-1248	E4S75PHR-1248	E4S75MSR-1248	E4S75SSR-1248	E4S75WMR-1248	E4S75WOR-1248	43.75"	48" Wide Upright	
E4S75ERR-1260	E4S75PHR-1260	E4S75MSR-1260	E4S75SSR-1260	E4S75WMR-1260	E4S75WOR-1260	26.75"	60" Wide Upright	
E4S75ERR-1272	E4S75PHR-1272	E4S75MSR-1272	E4S75SSR-1272	E4S75WMR-1272	E4S75WOR-1272	32.75"	72" Wide Upright	
E4S75ERR-1284	E4S75PHR-1284	E4S75MSR-1284	E4S75SSR-1284	E4S75WMR-1284	E4S75WOR-1284	38.75"	84" Wide Upright	
E4S75ERR-1296	E4S75PHR-1296	E4S75MSR-1296	E4S75SSR-1296	E4S75WMR-1296	E4S75WOR-1296	44.75"	96" Wide Upright	
13" Deep								
E4S75ERR-1342	E4S75PHR-1342	E4S75MSR-1342	E4S75SSR-1342	E4S75WMR-1342	E4S75WOR-1342	37.75"	42" Wide Upright	
E4S75ERR-1348	E4S75PHR-1348	E4S75MSR-1348	E4S75SSR-1348	E4S75WMR-1348	E4S75WOR-1348	43.75"	48" Wide Upright	
E4S75ERR-1360	E4S75PHR-1360	E4S75MSR-1360	E4S75SSR-1360	E4S75WMR-1360	E4S75WOR-1360	26.75"	60" Wide Upright	
E4S75ERR-1372	E4S75PHR-1372	E4S75MSR-1372	E4S75SSR-1372	E4S75WMR-1372	E4S75WOR-1372	32.75"	72" Wide Upright	
E4S75ERR-1384	E4S75PHR-1384	E4S75MSR-1384	E4S75SSR-1384	E4S75WMR-1384	E4S75WOR-1384	38.75"	84" Wide Upright	
E4S75ERR-1396	E4S75PHR-1396	E4S75MSR-1396	E4S75SSR-1396	E4S75WMR-1396	E4S75WOR-1396	44.75"	96" Wide Upright	
15" Deep								
E4S75ERR-1542	E4S75PHR-1542	E4S75MSR-1542	E4S75SSR-1542	E4S75WMR-1542	E4S75WOR-1542	37.75"	42" Wide Upright	
E4S75ERR-1548	E4S75PHR-1548	E4S75MSR-1548	E4S75SSR-1548	E4S75WMR-1548	E4S75WOR-1548	43.75"	48" Wide Upright	
E4S75ERR-1560	E4S75PHR-1560	E4S75MSR-1560	E4S75SSR-1560	E4S75WMR-1560	E4S75WOR-1560	26.75"	60" Wide Upright	
E4S75ERR-1572	E4S75PHR-1572	E4S75MSR-1572	E4S75SSR-1572	E4S75WMR-1572	E4S75WOR-1572	32.75"	72" Wide Upright	
E4S75ERR-1584	E4S75PHR-1584	E4S75MSR-1584	E4S75SSR-1584	E4S75WMR-1584	E4S75WOR-1584	38.75"	84" Wide Upright	
E4S75ERR-1596	E4S75PHR-1596	E4S75MSR-1596	E4S75SSR-1596	E4S75WMR-1596	E4S75WOR-1596	44.75"	96" Wide Upright	
16" Deep								
E4S75ERR-1642	E4S75PHR-1642	E4S75MSR-1642	E4S75SSR-1642	E4S75WMR-1642	E4S75WOR-1642	37.75"	42" Wide Upright	
E4S75ERR-1648	E4S75PHR-1648	E4S75MSR-1648	E4S75SSR-1648	E4S75WMR-1648	E4S75WOR-1648	43.75"	48" Wide Upright	
E4S75ERR-1660	E4S75PHR-1660	E4S75MSR-1660	E4S75SSR-1660	E4S75WMR-1660	E4S75WOR-1660	26.75"	60" Wide Upright	
E4S75ERR-1672	E4S75PHR-1672	E4S75MSR-1672	E4S75SSR-1672	E4S75WMR-1672	E4S75WOR-1672	32.75"	72" Wide Upright	
E4S75ERR-1684	E4S75PHR-1684	E4S75MSR-1684	E4S75SSR-1684	E4S75WMR-1684	E4S75WOR-1684	38.75"	84" Wide Upright	
E4S75ERR-1696	E4S75PHR-1696	E4S75MSR-1696	E4S75SSR-1696	E4S75WMR-1696	E4S75WOR-1696	44.75"	96" Wide Upright	
18" Deep								
E4S75ERR-1842	E4S75PHR-1842	E4S75MSR-1842	E4S75SSR-1842	E4S75WMR-1842	E4S75WOR-1842	37.75"	42" Wide Upright	
E4S75ERR-1848	E4S75PHR-1848	E4S75MSR-1848	E4S75SSR-1848	E4S75WMR-1848	E4S75WOR-1848	43.75"	48" Wide Upright	
E4S75ERR-1860	E4S75PHR-1860	E4S75MSR-1860	E4S75SSR-1860	E4S75WMR-1860	E4S75WOR-1860	26.75"	60" Wide Upright	
E4S75ERR-1872	E4S75PHR-1872	E4S75MSR-1872	E4S75SSR-1872	E4S75WMR-1872	E4S75WOR-1872	32.75"	72" Wide Upright	
E4S75ERR-1884	E4S75PHR-1884	E4S75MSR-1884	E4S75SSR-1884	E4S75WMR-1884	E4S75WOR-1884	38.75"	84" Wide Upright	
E4S75ERR-1896	E4S75PHR-1896	E4S75MSR-1896	E4S75SSR-1896	E4S75WMR-1896	E4S75WOR-1896	44.75"	96" Wide Upright	

Envision 4.0 - 1" Thick Shelving with Cutouts for Rear Rod

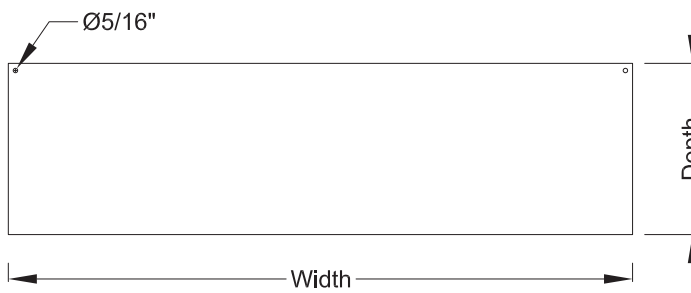

- These shelves to be used with Envision 4.0 brackets
- Each part number includes (1) shelf. If purchasing shelves for 60" uprights or wider you must order (2) shelves
- These shelves include cutouts for rear rod

Epoxy	Cat. No.		Painted Steel	Stainless Steel	Wood - Maple	Wood - Oak	Actual Width	For Use With:
	Phenolic							
9.5" Deep								
E4S1ERR-9542	E4S1PHR-9542	E4S1MSR-9542	E4S1SSR-9542	E4S1WMR-9542	E4S1WOR-9542	37.75"	42" Wide Upright	
E4S1ERR-9548	E4S1PHR-9548	E4S1MSR-9548	E4S1SSR-9548	E4S1WMR-9548	E4S1WOR-9548	43.75"	48" Wide Upright	
E4S1ERR-9560	E4S1PHR-9560	E4S1MSR-9560	E4S1SSR-9560	E4S1WMR-9560	E4S1WOR-9560	26.75"	60" Wide Upright	
E4S1ERR-9572	E4S1PHR-9572	E4S1MSR-9572	E4S1SSR-9572	E4S1WMR-9572	E4S1WOR-9572	32.75"	72" Wide Upright	
E4S1ERR-9584	E4S1PHR-9584	E4S1MSR-9584	E4S1SSR-9584	E4S1WMR-9584	E4S1WOR-9584	38.75"	84" Wide Upright	
E4S1ERR-9596	E4S1PHR-9596	E4S1MSR-9596	E4S1SSR-9596	E4S1WMR-9596	E4S1WOR-9596	44.75"	96" Wide Upright	
12" Deep								
E4S1ERR-1242	E4S1PHR-1242	E4S1MSR-1242	E4S1SSR-1242	E4S1WMR-1242	E4S1WOR-1242	37.75"	42" Wide Upright	
E4S1ERR-1248	E4S1PHR-1248	E4S1MSR-1248	E4S1SSR-1248	E4S1WMR-1248	E4S1WOR-1248	43.75"	48" Wide Upright	
E4S1ERR-1260	E4S1PHR-1260	E4S1MSR-1260	E4S1SSR-1260	E4S1WMR-1260	E4S1WOR-1260	26.75"	60" Wide Upright	
E4S1ERR-1272	E4S1PHR-1272	E4S1MSR-1272	E4S1SSR-1272	E4S1WMR-1272	E4S1WOR-1272	32.75"	72" Wide Upright	
E4S1ERR-1284	E4S1PHR-1284	E4S1MSR-1284	E4S1SSR-1284	E4S1WMR-1284	E4S1WOR-1284	38.75"	84" Wide Upright	
E4S1ERR-1296	E4S1PHR-1296	E4S1MSR-1296	E4S1SSR-1296	E4S1WMR-1296	E4S1WOR-1296	44.75"	96" Wide Upright	
13" Deep								
E4S1ERR-1342	E4S1PHR-1342	E4S1MSR-1342	E4S1SSR-1342	E4S1WMR-1342	E4S1WOR-1342	37.75"	42" Wide Upright	
E4S1ERR-1348	E4S1PHR-1348	E4S1MSR-1348	E4S1SSR-1348	E4S1WMR-1348	E4S1WOR-1348	43.75"	48" Wide Upright	
E4S1ERR-1360	E4S1PHR-1360	E4S1MSR-1360	E4S1SSR-1360	E4S1WMR-1360	E4S1WOR-1360	26.75"	60" Wide Upright	
E4S1ERR-1372	E4S1PHR-1372	E4S1MSR-1372	E4S1SSR-1372	E4S1WMR-1372	E4S1WOR-1372	32.75"	72" Wide Upright	
E4S1ERR-1384	E4S1PHR-1384	E4S1MSR-1384	E4S1SSR-1384	E4S1WMR-1384	E4S1WOR-1384	38.75"	84" Wide Upright	
E4S1ERR-1396	E4S1PHR-1396	E4S1MSR-1396	E4S1SSR-1396	E4S1WMR-1396	E4S1WOR-1396	44.75"	96" Wide Upright	
15" Deep								
E4S1ERR-1542	E4S1PHR-1542	E4S1MSR-1542	E4S1SSR-1542	E4S1WMR-1542	E4S1WOR-1542	37.75"	42" Wide Upright	
E4S1ERR-1548	E4S1PHR-1548	E4S1MSR-1548	E4S1SSR-1548	E4S1WMR-1548	E4S1WOR-1548	43.75"	48" Wide Upright	
E4S1ERR-1560	E4S1PHR-1560	E4S1MSR-1560	E4S1SSR-1560	E4S1WMR-1560	E4S1WOR-1560	26.75"	60" Wide Upright	
E4S1ERR-1572	E4S1PHR-1572	E4S1MSR-1572	E4S1SSR-1572	E4S1WMR-1572	E4S1WOR-1572	32.75"	72" Wide Upright	
E4S1ERR-1584	E4S1PHR-1584	E4S1MSR-1584	E4S1SSR-1584	E4S1WMR-1584	E4S1WOR-1584	38.75"	84" Wide Upright	
E4S1ERR-1596	E4S1PHR-1596	E4S1MSR-1596	E4S1SSR-1596	E4S1WMR-1596	E4S1WOR-1596	44.75"	96" Wide Upright	
16" Deep								
E4S1ERR-1642	E4S1PHR-1642	E4S1MSR-1642	E4S1SSR-1642	E4S1WMR-1642	E4S1WOR-1642	37.75"	42" Wide Upright	
E4S1ERR-1648	E4S1PHR-1648	E4S1MSR-1648	E4S1SSR-1648	E4S1WMR-1648	E4S1WOR-1648	43.75"	48" Wide Upright	
E4S1ERR-1660	E4S1PHR-1660	E4S1MSR-1660	E4S1SSR-1660	E4S1WMR-1660	E4S1WOR-1660	26.75"	60" Wide Upright	
E4S1ERR-1672	E4S1PHR-1672	E4S1MSR-1672	E4S1SSR-1672	E4S1WMR-1672	E4S1WOR-1672	32.75"	72" Wide Upright	
E4S1ERR-1684	E4S1PHR-1684	E4S1MSR-1684	E4S1SSR-1684	E4S1WMR-1684	E4S1WOR-1684	38.75"	84" Wide Upright	
E4S1ERR-1696	E4S1PHR-1696	E4S1MSR-1696	E4S1SSR-1696	E4S1WMR-1696	E4S1WOR-1696	44.75"	96" Wide Upright	
18" Deep								
E4S1ERR-1842	E4S1PHR-1842	E4S1MSR-1842	E4S1SSR-1842	E4S1WMR-1842	E4S1WOR-1842	37.75"	42" Wide Upright	
E4S1ERR-1848	E4S1PHR-1848	E4S1MSR-1848	E4S1SSR-1848	E4S1WMR-1848	E4S1WOR-1848	43.75"	48" Wide Upright	
E4S1ERR-1860	E4S1PHR-1860	E4S1MSR-1860	E4S1SSR-1860	E4S1WMR-1860	E4S1WOR-1860	26.75"	60" Wide Upright	
E4S1ERR-1872	E4S1PHR-1872	E4S1MSR-1872	E4S1SSR-1872	E4S1WMR-1872	E4S1WOR-1872	32.75"	72" Wide Upright	
E4S1ERR-1884	E4S1PHR-1884	E4S1MSR-1884	E4S1SSR-1884	E4S1WMR-1884	E4S1WOR-1884	38.75"	84" Wide Upright	
E4S1ERR-1896	E4S1PHR-1896	E4S1MSR-1896	E4S1SSR-1896	E4S1WMR-1896	E4S1WOR-1896	44.75"	96" Wide Upright	

Envision 4.0

Envision 4.0 - Bookend Brackets

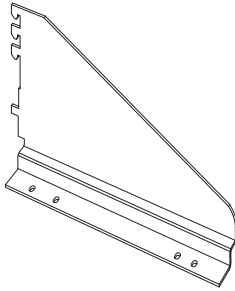

- These brackets to be used with Envision 4.0 uprights
- Sold in pairs

Cat. No.		Depth
Painted Steel	Stainless Steel	
.75" Thick Shelf		
E4SBB75-9	E4SBB75-9S	9"
E4SBB75-12	E4SBB75-12S	12"
E4SBB75-15	E4SBB75-15S	15"
1" Thick Shelf		
E4SBB1-9	E4SBB1-9S	9"
E4SBB1-12	E4SBB1-12S	12"
E4SBB1-15	E4SBB1-15S	15"

Envision 4.0 - Inverted Brackets

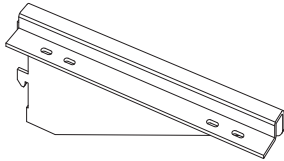

- These brackets to be used with Envision 4.0 uprights
- Sold in pairs

Cat. No.		Depth
Painted Steel	Stainless Steel	
.75" Thick Shelf		
E4SBI75-9	E4SBI75-9S	9"
E4SBI75-12	E4SBI75-12S	12"
E4SBI75-15	E4SBI75-15S	15"
1" Thick Shelf		
E4SBI1-9	E4SBI1-9S	9"
E4SBI1-12	E4SBI1-12S	12"
E4SBI1-15	E4SBI1-15S	15"

Envision 4.0 - Shelf Lip

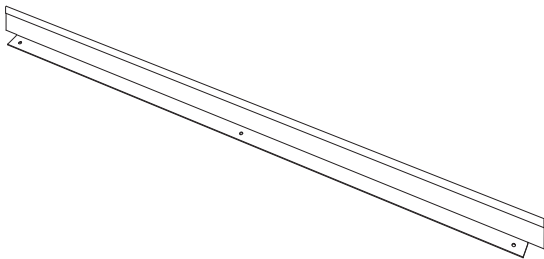

- These shelf lips to be used with Envision 4.0 shelves

Cat. No.		Width
Painted Steel	Stainless Steel	
Shelf Lip Front Mount		
E4SLF-42	E4SLF-42S	37.75"
E4SLF-48	E4SLF-48S	43.75"
E4SLF-60	E4SLF-60S	26.75"
E4SLF-72	E4SLF-72S	32.75"
E4SLF-84	E4SLF-84S	38.75"
E4SLF-96	E4SLF-96S	44.75"
Shelf Lip Rear Mount		
E4SLR-42	E4SLR-42S	37.75"
E4SLR-48	E4SLR-48S	43.75"
E4SLR-60	E4SLR-60S	26.75"
E4SLR-72	E4SLR-72S	32.75"
E4SLR-84	E4SLR-84S	38.75"
E4SLR-96	E4SLR-96S	44.75"

Envision 4.0 - Front Shelf Rod

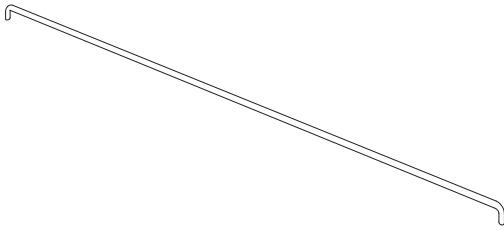

- These shelf rods to be used with Envision 4.0 shelves
- Each part number includes (1) front shelf rod. If purchasing shelf rods for 60" uprights or wider you must order (2) front shelf rods

Cat. No.		Width
Aluminum	Stainless Steel	
E4SRF-42	E4SRF-42S	38.875"
E4SRF-48	E4SRF-48S	44.875"
E4SRF-60	E4SRF-60S	27.875"
E4SRF-72	E4SRF-72S	33.875"
E4SRF-84	E4SRF-84S	39.875"
E4SRF-96	E4SRF-96S	45.875"

Envision 4.0 - Rear Shelf Rod

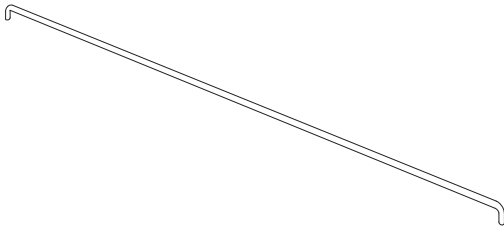

- These shelf rods to be used with Envision 4.0 shelves
- Each part number includes (1) rear shelf rod. If purchasing shelf rods for 60" uprights or wider you must order (2) rear shelf rods

Cat. No.		Width
Aluminum	Stainless Steel	
E4SRR-42	E4SRR-42S	36.75"
E4SRR-48	E4SRR-48S	42.75"
E4SRR-60	E4SRR-60S	25.75"
E4SRR-72	E4SRR-72S	31.75"
E4SRR-84	E4SRR-84S	37.75"
E4SRR-96	E4SRR-96S	43.75"

Envision 4.0 - Side Shelf Rod

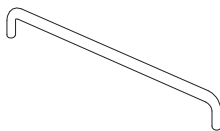

- These shelf rods to be used with Envision 4.0 shelves

Cat. No.		Depth
Aluminum	Stainless Steel	
E4SRS-9	E4SRS-9S	7"
E4SRS-12	E4SRS-12S	10"
E4SRS-15	E4SRS-15S	13"

Envision 4.0 - Wall Cabinet Hanger Bars

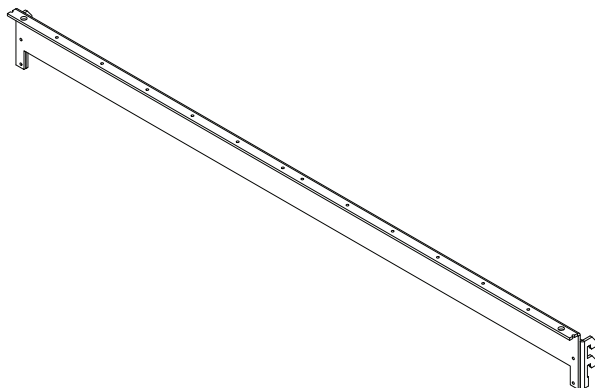

- These wall cabinet hangers to be used with Envision 4.0 uprights
- Each part number includes a pair of hanger bar. If purchasing hanger bars for 60" uprights or wider you must order (2) pairs of hanger bars

Cat. No.		Actual Width	For use with:
Painted Steel	Stainless Steel		
E4PWCH-42	E4PWCH-42S	42"	42" wide uprights
E4PWCH-48	E4PWCH-48S	48"	48" wide uprights
E4PWCH-60	E4PWCH-60S	30"	60" wide uprights
E4PWCH-72	E4PWCH-72S	36"	72" wide uprights
E4PWCH-84	E4PWCH-84S	42"	84" wide uprights
E4PWCH-96	E4PWCH-96S	48"	96" wide uprights

Envision 4.0

Envision 4.0 - Cabinet Stop

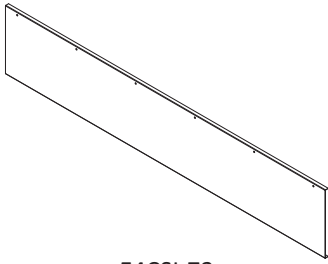

E4CSI-72

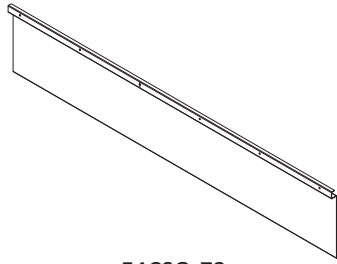

E4CSO-72

- These Cabinet Stops are to be used with Envision 4.0
- They are to prevent mobile cabinet from rolling to far under the work surface

Cat. No.		Actual Width	Width
For Inset Cabinet	For Overlay Cabinet		
E4CSI-42	E4CSO-42		42"
E4CSI-48	E4CSO-48	40.75"	48"
E4CSI-60	E4CSO-60	52.75"	60"
E4CSI-72	E4CSO-72	64.75"	72"
E4CSI-84	E4CSO-84		84"
E4CSI-96	E4CSO-96		96"

Envision 4.0 - Stabilizer Bar

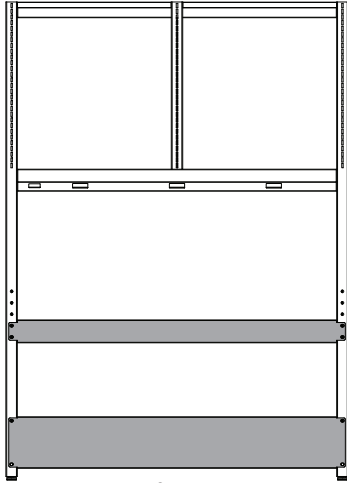

Elevation of Stabilizer Bars

- These Stabilizer Bars are to be used with Envision 4.0

Cat. No.		Width
Lower Brace	Upper Brace	
E4SBRL-42	E4SBRU-42	42"
E4SBRL-48	E4SBRU-48	48"
E4SBRL-60	E4SBRU-60	60"
E4SBRL-72	E4SBRU-72	72"
E4SBRL-84	E4SBRU-84	84"
E4SBRL-96	E4SBRU-96	96"

Envision 4.0 - Table Support Clamps



- These are to be used with Envision 4.0
- Kit of 2 with hardware
- Use for all tables on backside of 6" uprights

Cat. No.	Type
E4TSC	Table Support Clamps

Envision 4.0 - 3" Mounting Kits

- These are to be used with Envision 4.0
- Fasteners for connecting back to back 3" uprights

Cat. No.	Type
E4MKU3	Upright Connectors

LED Task Lighting for Envision 4.0



- Touch and hold continuous dimming and 10 hour automatic turnoff
- Units with (1) light include: (1) LED task light, magnetic angle mount that allows for up to 25° adjustment, 60 watt power supply with magnetic mount and 6' white cord
- Units with (2) lights include: (2) LED task light, magnetic angle mount that allows for up to 25° adjustment, 60 watt power supply with magnetic mount, 6' white cord, and 1 interlink cord to connect lights
- 60 watt power supply with magnetic mount and 6' white cord
- Made with anodized aluminum
- Lasts up to 50,000 hours

Cat. No.	Quantity of Lights	Actual Width	For use with:
Single Sided			
TL17-LED	1	17"	42" wide Table
TL17-LED	1	17"	48" wide Table
TL34-LED	2	17"	60" wide Table
TL34-LED	2	17"	72" wide Table
TL34-LED	2	17"	84" with Table
TL34-LED	2	17"	96" wide Table
Double Sided			
TL17-LEDDBL	2	17"	42" wide Table
TL17-LEDDBL	2	17"	48" wide Table
TL34-LEDDBL	4	17"	60" wide Table
TL34-LEDDBL	4	17"	72" wide Table
TL34-LEDDBL	4	17"	84" with Table
TL34-LEDDBL	4	17"	96" wide Table

Add Leveling Casters to Envision Uprights

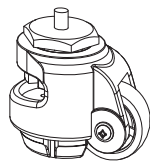

- (4) Leveling Caster has a disc style leveling function
- Weight capacity up to 1,000 lbs
- Can only be used with 3" uprights, Envision 3.0 or 4.0
- Casters add 3" to overall height of uprights
- Both Stabilizer Bars are recommended if using casters

Cat. No.	Type
E3HD-KIT	Add for Leveling Caster

Envision 4.0 Electrical

Envision 4.0 Electrical for 3" upright

Sample: E4W3A $\frac{\quad}{1} \frac{\quad}{2} \frac{\quad}{3}$ - (width of upright)

Space 1 Options:

G = Grey
I = Ivory
W = White

Space 2 Options:

4 = 4' cord above upright
6 = 6' cord above upright

Space 3 Options:

(Blank) = Standard outlet
G - GFI outlet

Cat. No.	Description	Width Options
E4W3A ___ - ___	1 circuit, 1 plug, 3 electrical outlets	42", 48"
E4W3B ___ - ___	2 circuit, 1 plug, 3 electrical outlets	42", 48"
E4W3C ___ - ___	2 circuit, 2 plug, 3 electrical outlets	42", 48"
E4W3D ___ - ___	1 circuit, 1 plug, 4 electrical outlets	60", 72", 84", 96"
E4W3E ___ - ___	2 circuit, 1 plug, 4 electrical outlets	60", 72", 84", 96"
E4W3F ___ - ___	2 circuit, 2 plug, 4 electrical outlets	60", 72", 84", 96"
E4W3G ___ - ___	4 circuit, 2 plug, 4 electrical outlets	60", 72", 84", 96"

Example: E4W3AG4G-48

Envision 4.0 Wiring for 3" upright, Grey, 1 circuit, 1 plug, 3 GFI outlets, for 48" wide upright

Note: All electrical components are UL Labeled and pre-wiring is UL Listed

Envision 4.0 Electrical for 6" upright

Sample: E4W6A $\frac{\quad}{1} \frac{\quad}{2} \frac{\quad}{3}$ - (width of upright)

Space 1 Options:

G = Grey
I = Ivory
W = White

Space 2 Options:

4 = 4' cord above upright
6 = 6' cord above upright

Space 3 Options:

(Blank) = Standard outlet
G - GFI outlet

Cat. No.	Description	Width Options
E4W6A ___ - ___	1 circuit, 1 plug, 3 electrical outlets	42", 48"
E4W6B ___ - ___	2 circuit, 1 plug, 3 electrical outlets	42", 48"
E4W6C ___ - ___	2 circuit, 2 plug, 3 electrical outlets	42", 48"
E4W6D ___ - ___	1 circuit, 1 plug, 4 electrical outlets	60", 72", 84", 96"
E4W6E ___ - ___	2 circuit, 1 plug, 4 electrical outlets	60", 72", 84", 96"
E4W6F ___ - ___	2 circuit, 2 plug, 4 electrical outlets	60", 72", 84", 96"
E4W6G ___ - ___	4 circuit, 2 plug, 4 electrical outlets	60", 72", 84", 96"

Example: E4W6AG4G-48

Envision 4.0 Wiring for 6" upright, Grey, 1 circuit, 1 plug, 6 GFI outlets, for 48" wide upright

Note: All electrical components are UL Labeled and pre-wiring is UL Listed

Envision 4.0 Data for 3" upright

Sample: E4D31 $\frac{\quad}{1} \frac{\quad}{2}$ - (width of upright)

Space 1 Options:

G = Light Grey

Space 2 Options:

4 = 4' cord above upright

6 = 6' cord above upright

Cat. No.	Description	Width Options
E4D31 ___ - ___	Single Data Outlet	42", 48", 60", 72", 84", 96"
E4D32 ___ - ___	Double Data Outlet	42", 48", 60", 72", 84", 96"

Example: E4D31G4-48

Envision 4.0 Data for 3" upright, Light Grey, Single Data Outlet, for 48" wide upright

Note: Data is CAT-5E

Envision 4.0 Data for 6" upright

Sample: E4D61 $\frac{\quad}{1} \frac{\quad}{2}$ - (width of upright)

Space 1 Options:

G = Light Grey

Space 2 Options:

4 = 4' cord above upright

6 = 6' cord above upright

Cat. No.	Description	Width Options
E4D61 ___ - ___	Single Data Outlet	42", 48", 60", 72", 84", 96"
E4D62 ___ - ___	Double Data Outlet	42", 48", 60", 72", 84", 96"

Example: E4D61G4-48

Envision 4.0 Data for 6" upright, Light Grey, Single Data Outlet, for 48" wide upright

Note: Data is CAT-5E

Envision 4.5

Envision 4.5
Undermount Bracket
and Shelves

Envision 4.5
Bookend Bracket
and Shelves

Envision 4.5
Plumbing Fixtures

Envision 4.5
Retaining Rods

Envision 4.5
Work Surface
in Epoxy or
Phenolic

Envision 4.5
Uprights

Optional Mobile
or Suspended
Cabinet

Envision 4.5
Bolt-On Frame

Non-marring Nylon
Leveling Feet

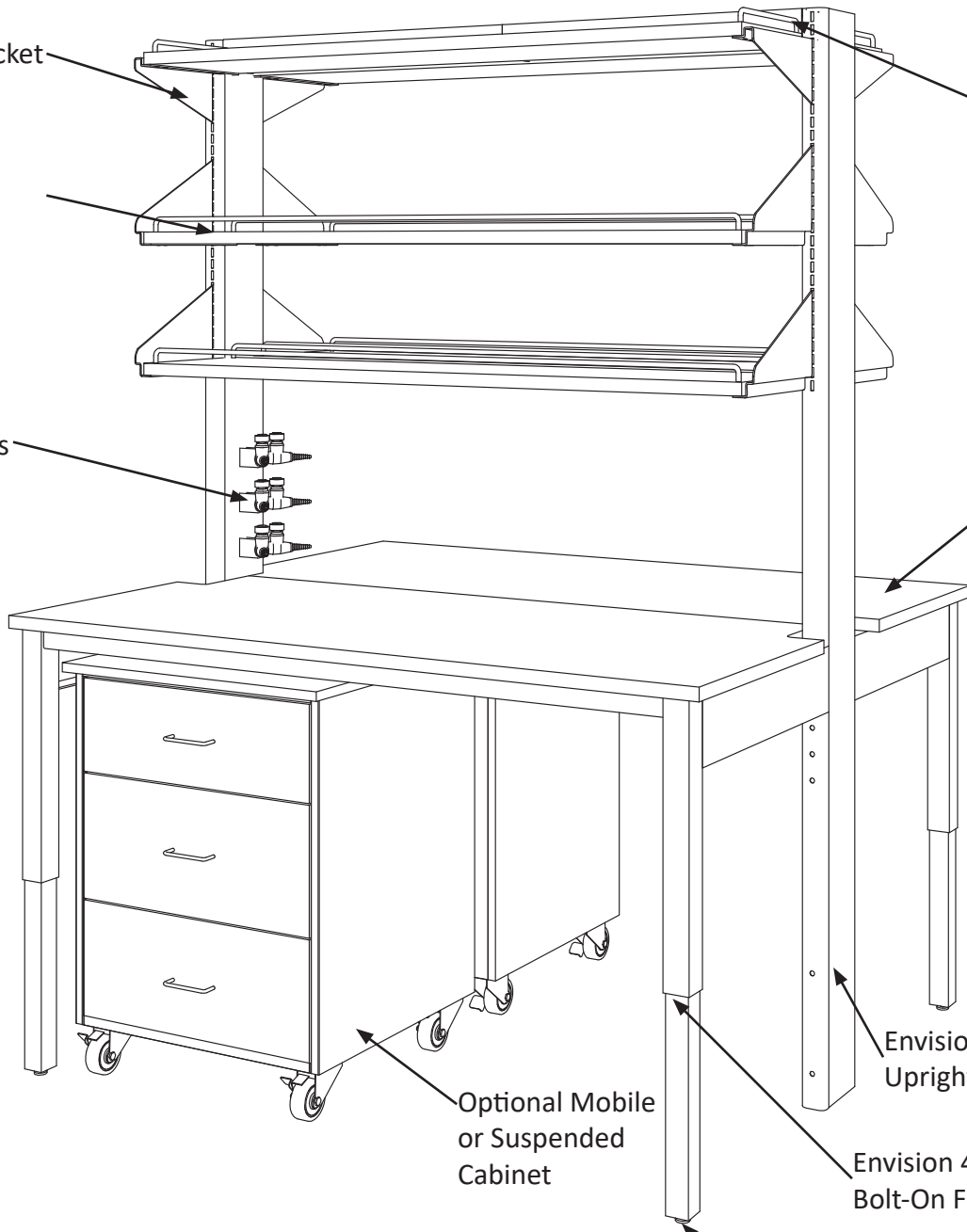

Envision 4.5 - 6" Uprights with Plumbing Cutouts Only

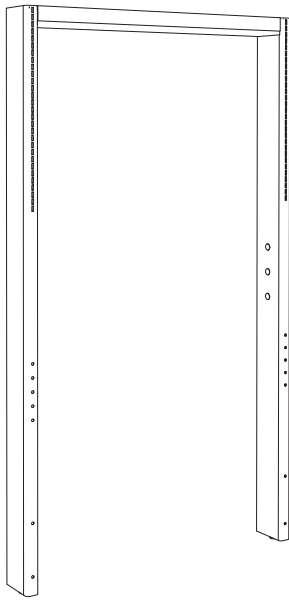

E45U6B-48

- Uprights are 6" Deep Envision 4.5, Double Sided
- Heights is 84"
- For Stainless Steel contact your ICI representative

Includes:

- (3) plumbing cutouts on one side

Cat. No.	Width
E45U6B-42	42"
E45U6B-48	48"
E45U6B-60	60"
E45U6B-72	72"

Envision 4.5 - 6" Uprights with Plumbing, and Data Cutouts Only

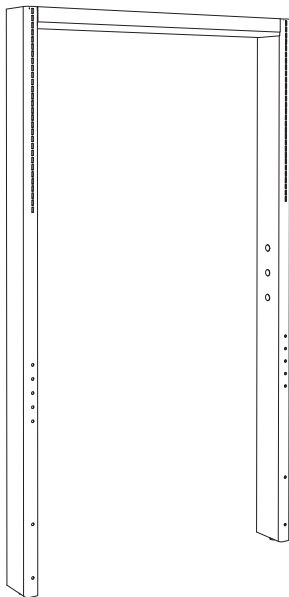

E45U6D-48

- Uprights are 6" Deep Envision 4.5, Double Sided
- Heights is 84"
- For Stainless Steel contact your ICI representative

Includes:

- (3) plumbing cutouts on one side
- (1) data cutout opposite side of plumbing cutouts

Cat. No.	Width
E45U6D-42	42"
E45U6D-48	48"
E45U6D-60	60"
E45U6D-72	72"

Envision 4.5

Envision 4.5 - 6" Uprights with Plumbing, Data, and Standard Electric Cutouts Only

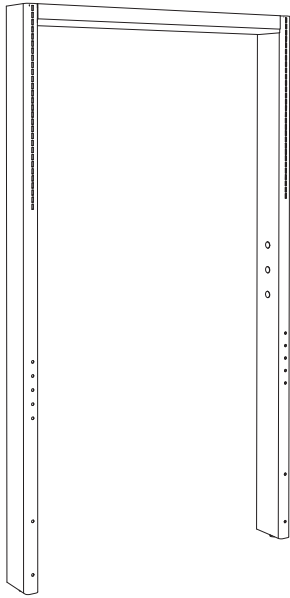

E45U6DE-48

- Uprights are 6" Deep Envision 4.5, Double Sided
- Heights is 84"
- For Stainless Steel contact your ICI representative

Includes:

- (3) plumbing cutouts on one side
- (1) data cutout opposite side of plumbing cutouts
- (6) standard electric cutouts on upper post opposite side of plumbing cutouts
- (2) standard electric cutout on lower post opposite side of the plumbing cutouts

Cat. No.	Width
E45U6DE-42	42"
E45U6DE-48	48"
E45U6DE-60	60"
E45U6DE-72	72"

Envision 4.5 - 6" Uprights with Plumbing, Data, and Standard & GFI Electric Cutouts Only

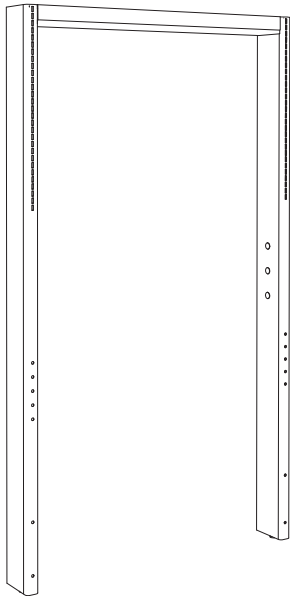

E45U6DEG-48

- Uprights are 6" Deep Envision 4.5, Double Sided
- Heights is 84"
- For Stainless Steel contact your ICI representative

Includes:

- (3) plumbing cutouts on one side
- (1) data cutout opposite side of plumbing cutouts
- (6) standard electric cutouts on upper post opposite side of plumbing cutouts
- (2) GFI electric cutout on lower post opposite side of the plumbing cutouts

Cat. No.	Width
E45U6DEG-42	42"
E45U6DEG-48	48"
E45U6DEG-60	60"
E45U6DEG-72	72"

Envision 4.5 - 6" Uprights with Plumbing, and Standard Electric Cutouts Only

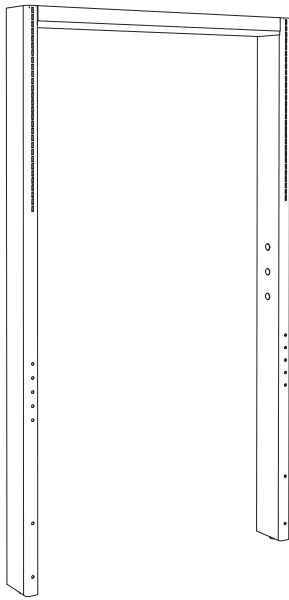

E45U6E-48

- Uprights are 6" Deep Envision 4.5, Double Sided
- Heights is 84"
- For Stainless Steel contact your ICI representative

Includes:

- (3) plumbing cutouts on one side
- (6) standard electric cutouts on upper post opposite side of plumbing cutouts
- (2) standard electric cutout on lower post opposite side of the plumbing cutouts

Cat. No.	Width
E45U6E-42	42"
E45U6E-48	48"
E45U6E-60	60"
E45U6E-72	72"

Envision 4.5 - 6" Uprights with Plumbing, and Standard & GFI Electric Cutouts Only

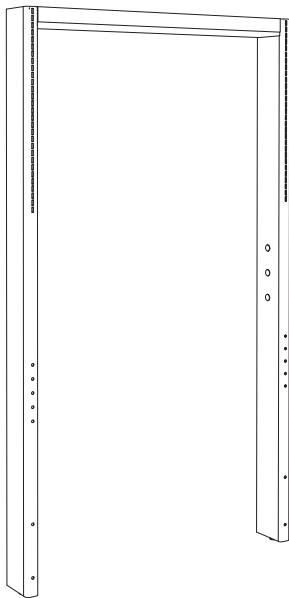

E45U6EG-48

- Uprights are 6" Deep Envision 4.5, Double Sided
- Heights is 84"
- For Stainless Steel contact your ICI representative

Includes:

- (3) plumbing cutouts on one side
- (6) standard electric cutouts on upper post opposite side of plumbing cutouts
- (2) GFI electric cutout on lower post opposite side of the plumbing cutouts

Cat. No.	Width
E45U6EG-42	42"
E45U6EG-48	48"
E45U6EG-60	60"
E45U6EG-72	72"

Envision 4.5

Envision 4.5 - Bolt-On Frame - 6" Uprights Double Sided

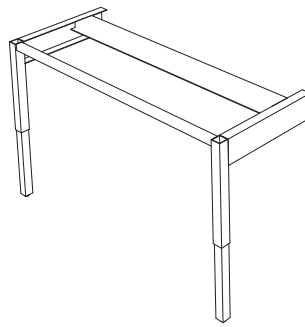
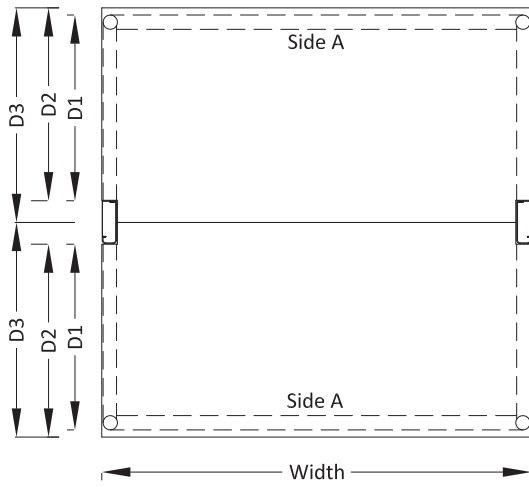

- Envision 4.5 Bolt-On Frames are to be attached to any Envision 4.5 uprights
- (2) Bolt-On Frames can be attached to 6" uprights to make a double sided workstation
- Adjustable Height work surface frame from 30 1/4" - 36 1/4", in 2" increments
- For Stainless Steel, contact your ICI Representative
- Work Surface depth details for Side B listed on previous page
- Work Surface depth details for Side A listed below see page 92 for work surface part numbers

Example of Envision 3.5, 6" Upright Double Sided Workstation with (2) Bolt-on Frames

Bolt-on Frame Cat. No.	Depth of Bolt-on Frame (D1)	Nominal Depth of Bolt-on Frame (D2)	Depth of Work Surface with 3" Notch (D3)	Width
Nominal 21" Deep				
E4CTFB-2142	20"	21"	24"	42"
E4CTFB-2148	20"	21"	24"	48"
E4CTFB-2160	20"	21"	24"	60"
E4CTFB-2172	20"	21"	24"	72"
Nominal 24" Deep				
E4CTFB-2442	23"	24"	27"	42"
E4CTFB-2448	23"	24"	27"	48"
E4CTFB-2460	23"	24"	27"	60"
E4CTFB-2472	23"	24"	27"	72"
Nominal 27" Deep				
E4CTFB-2742	26"	27"	30"	42"
E4CTFB-2748	26"	27"	30"	48"
E4CTFB-2760	26"	27"	30"	60"
E4CTFB-2772	26"	27"	30"	72"
Nominal 30" Deep				
E4CTFB-3042	29"	30"	33"	42"
E4CTFB-3048	29"	30"	33"	48"
E4CTFB-3060	29"	30"	33"	60"
E4CTFB-3072	29"	30"	33"	72"

Envision 4.5 - Bolt-On and Frame/Table - 6" Uprights Double Sided

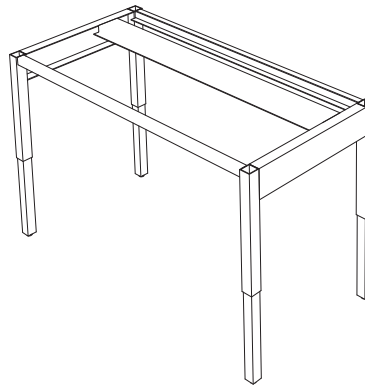
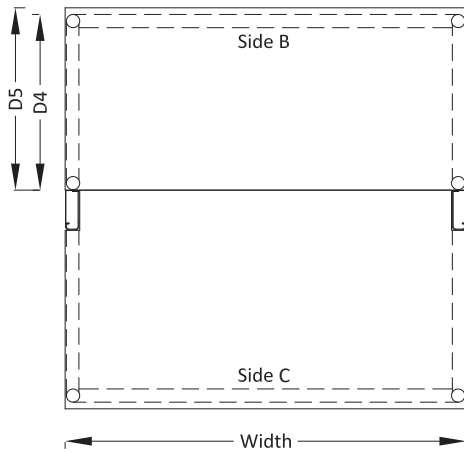

Example of Envision 4.5, 6" Upright Double Sided Workstation with (1) Bolt-on and (1) Frame/Table

- Envision 4.5 Countertop Frame/Tables are to be used to make a double sided workstation with a 3" or 6" upright
- Envision 4.5 Countertop Frame/Tables can also be free standing tables
- Adjustable Height work surface frame from 30 1/4" - 36 1/4", in 2" increments
- For Stainless Steel, contact your ICI Representative
- Work Surface ordered separately
- Work Surface depth details for Side C listed on next page
- Work Surface depth details for Side B listed below see page 94 for work surface part numbers

Bolt-on Frame Cat. No.	Depth of Frame/Table (D4)	Depth of Work Surface with No Notch (D5)	Width	Bolt-on Frame Cat. No.	Depth of Frame/Table (D4)	Depth of Work Surface with No Notch (D5)	Width
Nominal 15" Deep				Nominal 27" Deep			
E4CTFT-1542	14"	15"	42"	E4CTFT-2742	26"	27"	42"
E4CTFT-1548	14"	15"	48"	E4CTFT-2748	26"	27"	48"
E4CTFT-1560	14"	15"	60"	E4CTFT-2760	26"	27"	60"
E4CTFT-1572	14"	15"	72"	E4CTFT-2772	26"	27"	72"
Nominal 18" Deep				Nominal 30" Deep			
E4CTFT-1842	17"	18"	42"	E4CTFT-3042	29"	30"	42"
E4CTFT-1848	17"	18"	48"	E4CTFT-3048	29"	30"	48"
E4CTFT-1860	17"	18"	60"	E4CTFT-3060	29"	30"	60"
E4CTFT-1872	17"	18"	72"	E4CTFT-3072	29"	30"	72"
Nominal 19" Deep				Nominal 33" Deep			
E4CTFT-1942	18"	19"	42"	E4CTFT-3342	32"	33"	42"
E4CTFT-1948	18"	19"	48"	E4CTFT-3348	32"	33"	48"
E4CTFT-1960	18"	19"	60"	E4CTFT-3360	32"	33"	60"
E4CTFT-1972	18"	19"	72"	E4CTFT-3372	32"	33"	72"
Nominal 21" Deep				Nominal 36" Deep			
E4CTFT-2142	20"	21"	42"	E4CTFT-3642	35"	36"	42"
E4CTFT-2148	20"	21"	48"	E4CTFT-3648	35"	36"	48"
E4CTFT-2160	20"	21"	60"	E4CTFT-3660	35"	36"	60"
E4CTFT-2172	20"	21"	72"	E4CTFT-3672	35"	36"	72"
Nominal 24" Deep							
E4CTFT-2442	23"	24"	42"				
E4CTFT-2448	23"	24"	48"				
E4CTFT-2460	23"	24"	60"				
E4CTFT-2472	23"	24"	72"				

Envision 4.5

Envision 4.5 - Bolt-On and Table - 6" Uprights Double Sided

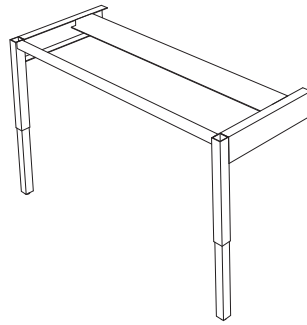
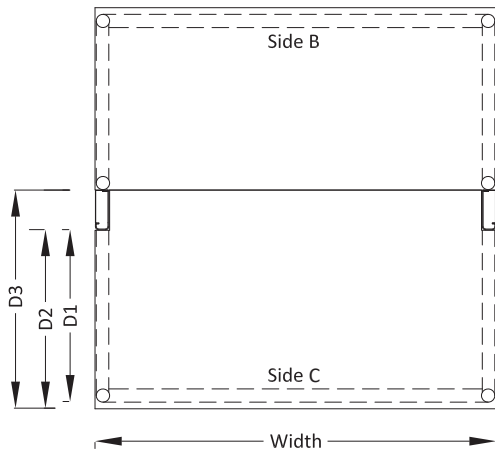

- Envision 4.5 Tables are to be used to make a double sided workstation with a 3" or 6" upright
- Envision 4.5 Tables can also be free standing tables
- Adjustable Height work surface frame from 30 1/4" - 36 1/4", in 2" increments
- For Stainless Steel, contact your ICI Representative
- Work Surface ordered separately
- Work Surface depth details for Side B listed on previous page
- Work Surface depth details for Side C listed below see page 93 for work surface part numbers

Example of Envision 4.5, 6" Upright Double Sided Workstation with (1) Bolt-on and (1) Table

Bolt-on Frame Cat. No.	Depth of Bolt-on Frame (D1)	Nominal Depth of Bolt-on Frame (D2)	Depth of Work Surface with 6" Notch (D3)	Width
Nominal 21" Deep				
E4CTFB-2142	20"	21"	27"	42"
E4CTFB-2148	20"	21"	27"	48"
E4CTFB-2160	20"	21"	27"	60"
E4CTFB-2172	20"	21"	27"	72"
Nominal 24" Deep				
E4CTFB-2442	23"	24"	30"	42"
E4CTFB-2448	23"	24"	30"	48"
E4CTFB-2460	23"	24"	30"	60"
E4CTFB-2472	23"	24"	30"	72"
Nominal 27" Deep				
E4CTFB-2742	26"	27"	33"	42"
E4CTFB-2748	26"	27"	33"	48"
E4CTFB-2760	26"	27"	33"	60"
E4CTFB-2772	26"	27"	33"	72"
Nominal 30" Deep				
E4CTFB-3042	29"	30"	36"	42"
E4CTFB-3048	29"	30"	36"	48"
E4CTFB-3060	29"	30"	36"	60"
E4CTFB-3072	29"	30"	36"	72"

Envision 4.5 - 3" Upright Notched Work Surface

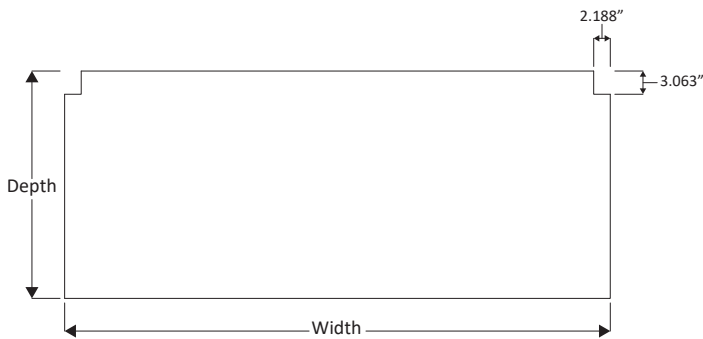

- This work surface is to be used with Envision 4.5, 6" upright

Epoxy	Cat. No. Phenolic	Stainless Steel	Width
24" Deep Top			
E4CT1ER3-2442	E4CT1PH3-2442	E4CT1SS3-2442	42"
E4CT1ER3-2448	E4CT1PH3-2448	E4CT1SS3-2448	48"
E4CT1ER3-2460	E4CT1PH3-2460	E4CT1SS3-2460	60"
E4CT1ER3-2472	E4CT1PH3-2472	E4CT1SS3-2472	72"
27" Deep Top			
E4CT1ER3-2742	E4CT1PH3-2742	E4CT1SS3-2742	42"
E4CT1ER3-2748	E4CT1PH3-2748	E4CT1SS3-2748	48"
E4CT1ER3-2760	E4CT1PH3-2760	E4CT1SS3-2760	60"
E4CT1ER3-2772	E4CT1PH3-2772	E4CT1SS3-2772	72"
30" Deep Top			
E4CT1ER3-3042	E4CT1PH3-3042	E4CT1SS3-3042	42"
E4CT1ER3-3048	E4CT1PH3-3048	E4CT1SS3-3048	48"
E4CT1ER3-3060	E4CT1PH3-3060	E4CT1SS3-3060	60"
E4CT1ER3-3072	E4CT1PH3-3072	E4CT1SS3-3072	72"
33" Deep Top			
E4CT1ER3-3342	E4CT1PH3-3342	E4CT1SS3-3342	42"
E4CT1ER3-3348	E4CT1PH3-3348	E4CT1SS3-3348	48"
E4CT1ER3-3360	E4CT1PH3-3360	E4CT1SS3-3360	60"
E4CT1ER3-3372	E4CT1PH3-3372	E4CT1SS3-3372	72"
36" Deep Top			
E4CT1ER3-3642	E4CT1PH3-3642	E4CT1SS3-3642	42"
E4CT1ER3-3648	E4CT1PH3-3648	E4CT1SS3-3648	48"
E4CT1ER3-3660	E4CT1PH3-3660	E4CT1SS3-3660	60"
E4CT1ER3-3672	E4CT1PH3-3672	E4CT1SS3-3672	72"

Envision 4.5

Envision 4.5 - 6" Upright Notched Work Surface

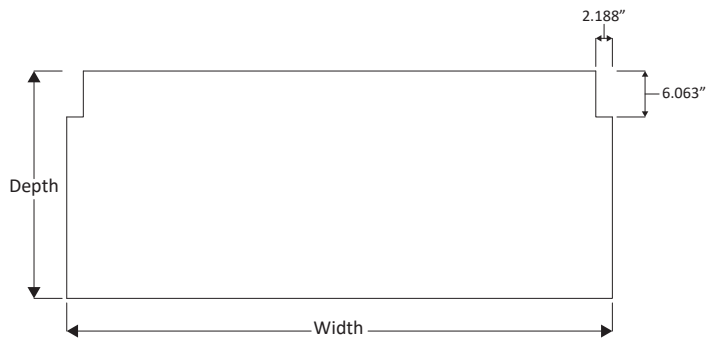

- This work surface is to be used with Envision 4.5, 6" upright

Epoxy	Cat. No. Phenolic	Stainless Steel	Width
27" Deep Top			
E4CT1ER6-2742	E4CT1PH6-2742	E4CT1SS6-2742	42"
E4CT1ER6-2748	E4CT1PH6-2748	E4CT1SS6-2748	48"
E4CT1ER6-2760	E4CT1PH6-2760	E4CT1SS6-2760	60"
E4CT1ER6-2772	E4CT1PH6-2772	E4CT1SS6-2772	72"
30" Deep Top			
E4CT1ER6-3042	E4CT1PH6-3042	E4CT1SS6-3042	42"
E4CT1ER6-3048	E4CT1PH6-3048	E4CT1SS6-3048	48"
E4CT1ER6-3060	E4CT1PH6-3060	E4CT1SS6-3060	60"
E4CT1ER6-3072	E4CT1PH6-3072	E4CT1SS6-3072	72"
33" Deep Top			
E4CT1ER6-3342	E4CT1PH6-3342	E4CT1SS6-3342	42"
E4CT1ER6-3348	E4CT1PH6-3348	E4CT1SS6-3348	48"
E4CT1ER6-3360	E4CT1PH6-3360	E4CT1SS6-3360	60"
E4CT1ER6-3372	E4CT1PH6-3372	E4CT1SS6-3372	72"
36" Deep Top			
E4CT1ER6-3642	E4CT1PH6-3642	E4CT1SS6-3642	42"
E4CT1ER6-3648	E4CT1PH6-3648	E4CT1SS6-3648	48"
E4CT1ER6-3660	E4CT1PH6-3660	E4CT1SS6-3660	60"
E4CT1ER6-3672	E4CT1PH6-3672	E4CT1SS6-3672	72"

Envision 4.5 - No Notch Work Surface

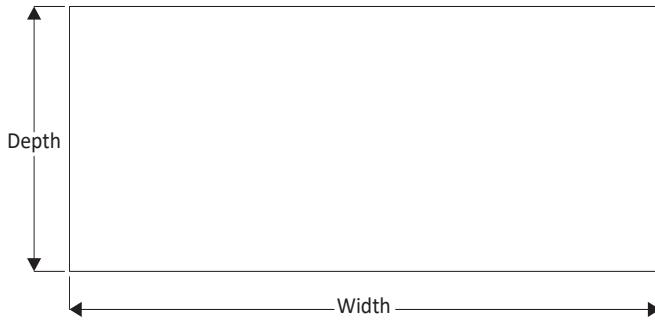

- This work surface is to be used with an Envision 4.5 Frame/ Table

15" Deep Top				27" Deep Top			
Epoxy	Cat. No. Phenolic	Stainless Steel	Width	Epoxy	Cat. No. Phenolic	Stainless Steel	Width
E4CT1ERT-1542	E4CT1PHT-1542	E4CT1SST-1542	42"	E4CT1ERT-2742	E4CT1PHT-2742	E4CT1SST-2742	42"
E4CT1ERT-1548	E4CT1PHT-1548	E4CT1SST-1548	48"	E4CT1ERT-2748	E4CT1PHT-2748	E4CT1SST-2748	48"
E4CT1ERT-1560	E4CT1PHT-1560	E4CT1SST-1560	60"	E4CT1ERT-2760	E4CT1PHT-2760	E4CT1SST-2760	60"
E4CT1ERT-1572	E4CT1PHT-1572	E4CT1SST-1572	72"	E4CT1ERT-2772	E4CT1PHT-2772	E4CT1SST-2772	72"
18" Deep Top				30" Deep Top			
E4CT1ERT-1842	E4CT1PHT-1842	E4CT1SST-1842	42"	E4CT1ERT-3042	E4CT1PHT-3042	E4CT1SST-3042	42"
E4CT1ERT-1848	E4CT1PHT-1848	E4CT1SST-1848	48"	E4CT1ERT-3048	E4CT1PHT-3048	E4CT1SST-3048	48"
E4CT1ERT-1860	E4CT1PHT-1860	E4CT1SST-1860	60"	E4CT1ERT-3060	E4CT1PHT-3060	E4CT1SST-3060	60"
E4CT1ERT-1872	E4CT1PHT-1872	E4CT1SST-1872	72"	E4CT1ERT-3072	E4CT1PHT-3072	E4CT1SST-3072	72"
19" Deep Top				33" Deep Top			
E4CT1ERT-1942	E4CT1PHT-1942	E4CT1SST-1942	42"	E4CT1ERT-3342	E4CT1PHT-3342	E4CT1SST-3342	42"
E4CT1ERT-1948	E4CT1PHT-1948	E4CT1SST-1948	48"	E4CT1ERT-3348	E4CT1PHT-3348	E4CT1SST-3348	48"
E4CT1ERT-1960	E4CT1PHT-1960	E4CT1SST-1960	60"	E4CT1ERT-3360	E4CT1PHT-3360	E4CT1SST-3360	60"
E4CT1ERT-1972	E4CT1PHT-1972	E4CT1SST-1972	72"	E4CT1ERT-3372	E4CT1PHT-3372	E4CT1SST-3372	72"
21" Deep Top				36" Deep Top			
E4CT1ERT-2142	E4CT1PHT-2142	E4CT1SST-2142	42"	E4CT1ERT-3642	E4CT1PHT-3642	E4CT1SST-3642	42"
E4CT1ERT-2148	E4CT1PHT-2148	E4CT1SST-2148	48"	E4CT1ERT-3648	E4CT1PHT-3648	E4CT1SST-3648	48"
E4CT1ERT-2160	E4CT1PHT-2160	E4CT1SST-2160	60"	E4CT1ERT-3660	E4CT1PHT-3660	E4CT1SST-3660	60"
E4CT1ERT-2172	E4CT1PHT-2172	E4CT1SST-2172	72"	E4CT1ERT-3672	E4CT1PHT-3672	E4CT1SST-3672	72"
24" Deep Top							
E4CT1ERT-2442	E4CT1PHT-2442	E4CT1SST-2442	42"				
E4CT1ERT-2448	E4CT1PHT-2448	E4CT1SST-2448	48"				
E4CT1ERT-2460	E4CT1PHT-2460	E4CT1SST-2460	60"				
E4CT1ERT-2472	E4CT1PHT-2472	E4CT1SST-2472	72"				

Envision 4.5

Envision 4.5 - .75" Thick Shelving - No Rear Rod Cutout

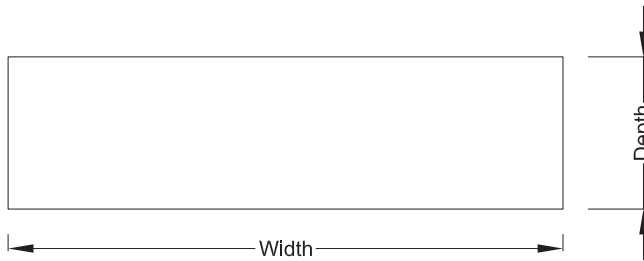

- These shelves to be used with Envision 4.5 brackets
- Each part number includes (1) shelf

Epoxy	Cat. No.		Painted Steel	Stainless Steel	Wood - Maple	Wood - Oak	Actual Width	For Use With:
	Phenolic							
9.5" Deep								
E45S75ER-9542	E45S75PH-9542	E45S75MS-9542	E45S75SS-9542	E45S75WM-9542	E45S75WO-9542	37.75"	42" Wide Upright	
E45S75ER-9548	E45S75PH-9548	E45S75MS-9548	E45S75SS-9548	E45S75WM-9548	E45S75WO-9548	43.75"	48" Wide Upright	
E45S75ER-9560	E45S75PH-9560	E45S75MS-9560	E45S75SS-9560	E45S75WM-9560	E45S75WO-9560	55.75"	60" Wide Upright	
E45S75ER-9572	E45S75PH-9572	E45S75MS-9572	E45S75SS-9572	E45S75WM-9572	E45S75WO-9572	67.75"	72" Wide Upright	
12" Deep								
E45S75ER-1242	E45S75PH-1242	E45S75MS-1242	E45S75SS-1242	E45S75WM-1242	E45S75WO-1242	37.75"	42" Wide Upright	
E45S75ER-1248	E45S75PH-1248	E45S75MS-1248	E45S75SS-1248	E45S75WM-1248	E45S75WO-1248	43.75"	48" Wide Upright	
E45S75ER-1260	E45S75PH-1260	E45S75MS-1260	E45S75SS-1260	E45S75WM-1260	E45S75WO-1260	55.75"	60" Wide Upright	
E45S75ER-1272	E45S75PH-1272	E45S75MS-1272	E45S75SS-1272	E45S75WM-1272	E45S75WO-1272	67.75"	72" Wide Upright	
13" Deep								
E45S75ER-1342	E45S75PH-1342	E45S75MS-1342	E45S75SS-1342	E45S75WM-1342	E45S75WO-1342	37.75"	42" Wide Upright	
E45S75ER-1348	E45S75PH-1348	E45S75MS-1348	E45S75SS-1348	E45S75WM-1348	E45S75WO-1348	43.75"	48" Wide Upright	
E45S75ER-1360	E45S75PH-1360	E45S75MS-1360	E45S75SS-1360	E45S75WM-1360	E45S75WO-1360	55.75"	60" Wide Upright	
E45S75ER-1372	E45S75PH-1372	E45S75MS-1372	E45S75SS-1372	E45S75WM-1372	E45S75WO-1372	67.75"	72" Wide Upright	
15" Deep								
E45S75ER-1542	E45S75PH-1542	E45S75MS-1542	E45S75SS-1542	E45S75WM-1542	E45S75WO-1542	37.75"	42" Wide Upright	
E45S75ER-1548	E45S75PH-1548	E45S75MS-1548	E45S75SS-1548	E45S75WM-1548	E45S75WO-1548	43.75"	48" Wide Upright	
E45S75ER-1560	E45S75PH-1560	E45S75MS-1560	E45S75SS-1560	E45S75WM-1560	E45S75WO-1560	55.75"	60" Wide Upright	
E45S75ER-1572	E45S75PH-1572	E45S75MS-1572	E45S75SS-1572	E45S75WM-1572	E45S75WO-1572	67.75"	72" Wide Upright	
16" Deep								
E45S75ER-1642	E45S75PH-1642	E45S75MS-1642	E45S75SS-1642	E45S75WM-1642	E45S75WO-1642	37.75"	42" Wide Upright	
E45S75ER-1648	E45S75PH-1648	E45S75MS-1648	E45S75SS-1648	E45S75WM-1648	E45S75WO-1648	43.75"	48" Wide Upright	
E45S75ER-1660	E45S75PH-1660	E45S75MS-1660	E45S75SS-1660	E45S75WM-1660	E45S75WO-1660	55.75"	60" Wide Upright	
E45S75ER-1672	E45S75PH-1672	E45S75MS-1672	E45S75SS-1672	E45S75WM-1672	E45S75WO-1672	67.75"	72" Wide Upright	
18" Deep								
E45S75ER-1842	E45S75PH-1842	E45S75MS-1842	E45S75SS-1842	E45S75WM-1842	E45S75WO-1842	37.75"	42" Wide Upright	
E45S75ER-1848	E45S75PH-1848	E45S75MS-1848	E45S75SS-1848	E45S75WM-1848	E45S75WO-1848	43.75"	48" Wide Upright	
E45S75ER-1860	E45S75PH-1860	E45S75MS-1860	E45S75SS-1860	E45S75WM-1860	E45S75WO-1860	55.75"	60" Wide Upright	
E45S75ER-1872	E45S75PH-1872	E45S75MS-1872	E45S75SS-1872	E45S75WM-1872	E45S75WO-1872	67.75"	72" Wide Upright	

Envision 4.5 - 1" Thick Shelving - No Rear Rod Cutout

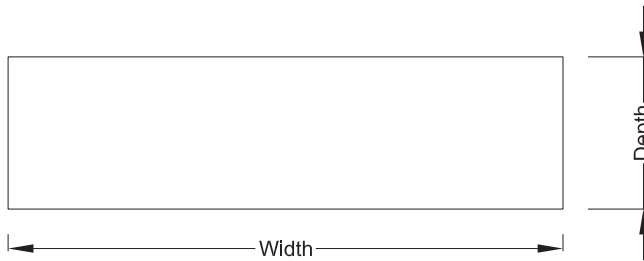

- These shelves to be used with Envision 4.5 brackets
- Each part number includes (1) shelf

Epoxy	Cat. No. Phenolic	Painted Steel	Stainless Steel	Wood - Maple	Wood - Oak	Actual Width	For Use With:
9.5" Deep							
E45S1ER-9542	E45S1PH-9542	E45S1MS-9542	E45S1SS-9542	E45S1WM-9542	E45S1WO-9542	37.75"	42" Wide Upright
E45S1ER-9548	E45S1PH-9548	E45S1MS-9548	E45S1SS-9548	E45S1WM-9548	E45S1WO-9548	43.75"	48" Wide Upright
E45S1ER-9560	E45S1PH-9560	E45S1MS-9560	E45S1SS-9560	E45S1WM-9560	E45S1WO-9560	55.75"	60" Wide Upright
E45S1ER-9572	E45S1PH-9572	E45S1MS-9572	E45S1SS-9572	E45S1WM-9572	E45S1WO-9572	67.75"	72" Wide Upright
12" Deep							
E45S1ER-1242	E45S1PH-1242	E45S1MS-1242	E45S1SS-1242	E45S1WM-1242	E45S1WO-1242	37.75"	42" Wide Upright
E45S1ER-1248	E45S1PH-1248	E45S1MS-1248	E45S1SS-1248	E45S1WM-1248	E45S1WO-1248	43.75"	48" Wide Upright
E45S1ER-1260	E45S1PH-1260	E45S1MS-1260	E45S1SS-1260	E45S1WM-1260	E45S1WO-1260	55.75"	60" Wide Upright
E45S1ER-1272	E45S1PH-1272	E45S1MS-1272	E45S1SS-1272	E45S1WM-1272	E45S1WO-1272	67.75"	72" Wide Upright
13" Deep							
E45S1ER-1342	E45S1PH-1342	E45S1MS-1342	E45S1SS-1342	E45S1WM-1342	E45S1WO-1342	37.75"	42" Wide Upright
E45S1ER-1348	E45S1PH-1348	E45S1MS-1348	E45S1SS-1348	E45S1WM-1348	E45S1WO-1348	43.75"	48" Wide Upright
E45S1ER-1360	E45S1PH-1360	E45S1MS-1360	E45S1SS-1360	E45S1WM-1360	E45S1WO-1360	55.75"	60" Wide Upright
E45S1ER-1372	E45S1PH-1372	E45S1MS-1372	E45S1SS-1372	E45S1WM-1372	E45S1WO-1372	67.75"	72" Wide Upright
15" Deep							
E45S1ER-1542	E45S1PH-1542	E45S1MS-1542	E45S1SS-1542	E45S1WM-1542	E45S1WO-1542	37.75"	42" Wide Upright
E45S1ER-1548	E45S1PH-1548	E45S1MS-1548	E45S1SS-1548	E45S1WM-1548	E45S1WO-1548	43.75"	48" Wide Upright
E45S1ER-1560	E45S1PH-1560	E45S1MS-1560	E45S1SS-1560	E45S1WM-1560	E45S1WO-1560	55.75"	60" Wide Upright
E45S1ER-1572	E45S1PH-1572	E45S1MS-1572	E45S1SS-1572	E45S1WM-1572	E45S1WO-1572	67.75"	72" Wide Upright
16" Deep							
E45S1ER-1642	E45S1PH-1642	E45S1MS-1642	E45S1SS-1642	E45S1WM-1642	E45S1WO-1642	37.75"	42" Wide Upright
E45S1ER-1648	E45S1PH-1648	E45S1MS-1648	E45S1SS-1648	E45S1WM-1648	E45S1WO-1648	43.75"	48" Wide Upright
E45S1ER-1660	E45S1PH-1660	E45S1MS-1660	E45S1SS-1660	E45S1WM-1660	E45S1WO-1660	55.75"	60" Wide Upright
E45S1ER-1672	E45S1PH-1672	E45S1MS-1672	E45S1SS-1672	E45S1WM-1672	E45S1WO-1672	67.75"	72" Wide Upright
18" Deep							
E45S1ER-1842	E45S1PH-1842	E45S1MS-1842	E45S1SS-1842	E45S1WM-1842	E45S1WO-1842	37.75"	42" Wide Upright
E45S1ER-1848	E45S1PH-1848	E45S1MS-1848	E45S1SS-1848	E45S1WM-1848	E45S1WO-1848	43.75"	48" Wide Upright
E45S1ER-1860	E45S1PH-1860	E45S1MS-1860	E45S1SS-1860	E45S1WM-1860	E45S1WO-1860	55.75"	60" Wide Upright
E45S1ER-1872	E45S1PH-1872	E45S1MS-1872	E45S1SS-1872	E45S1WM-1872	E45S1WO-1872	67.75"	72" Wide Upright

Envision 4.5

Envision 4.5 - .75" Thick Shelving with Cutouts for Rear Rod

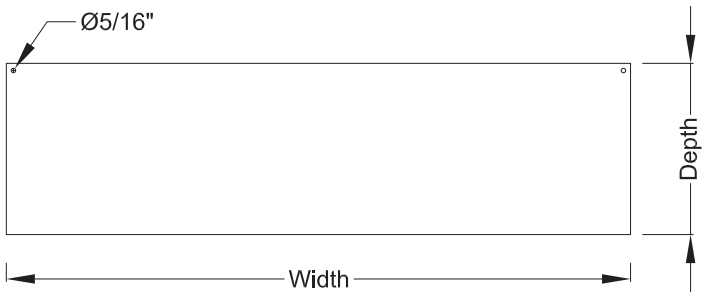

- These shelves to be used with Envision 4.5 brackets
- Each part number includes (1) shelf
- These shelves include cutouts for rear rod

Epoxy	Cat. No. Phenolic	Painted Steel	Stainless Steel	Wood - Maple	Wood - Oak	Actual Width	For Use With:
9.5" Deep							
E45S75ERR-9542	E45S75PHR-9542	E45S75MSR-9542	E45S75SSR-9542	E45S75WMMR-9542	E45S75WOR-9542	37.75"	42" Wide Upright
E45S75ERR-9548	E45S75PHR-9548	E45S75MSR-9548	E45S75SSR-9548	E45S75WMMR-9548	E45S75WOR-9548	43.75"	48" Wide Upright
E45S75ERR-9560	E45S75PHR-9560	E45S75MSR-9560	E45S75SSR-9560	E45S75WMMR-9560	E45S75WOR-9560	55.75"	60" Wide Upright
E45S75ERR-9572	E45S75PHR-9572	E45S75MSR-9572	E45S75SSR-9572	E45S75WMMR-9572	E45S75WOR-9572	67.75"	72" Wide Upright
12" Deep							
E45S75ERR-1242	E45S75PHR-1242	E45S75MSR-1242	E45S75SSR-1242	E45S75WMMR-1242	E45S75WOR-1242	37.75"	42" Wide Upright
E45S75ERR-1248	E45S75PHR-1248	E45S75MSR-1248	E45S75SSR-1248	E45S75WMMR-1248	E45S75WOR-1248	43.75"	48" Wide Upright
E45S75ERR-1260	E45S75PHR-1260	E45S75MSR-1260	E45S75SSR-1260	E45S75WMMR-1260	E45S75WOR-1260	55.75"	60" Wide Upright
E45S75ERR-1272	E45S75PHR-1272	E45S75MSR-1272	E45S75SSR-1272	E45S75WMMR-1272	E45S75WOR-1272	67.75"	72" Wide Upright
13" Deep							
E45S75ERR-1342	E45S75PHR-1342	E45S75MSR-1342	E45S75SSR-1342	E45S75WMMR-1342	E45S75WOR-1342	37.75"	42" Wide Upright
E45S75ERR-1348	E45S75PHR-1348	E45S75MSR-1348	E45S75SSR-1348	E45S75WMMR-1348	E45S75WOR-1348	43.75"	48" Wide Upright
E45S75ERR-1360	E45S75PHR-1360	E45S75MSR-1360	E45S75SSR-1360	E45S75WMMR-1360	E45S75WOR-1360	55.75"	60" Wide Upright
E45S75ERR-1372	E45S75PHR-1372	E45S75MSR-1372	E45S75SSR-1372	E45S75WMMR-1372	E45S75WOR-1372	67.75"	72" Wide Upright
15" Deep							
E45S75ERR-1542	E45S75PHR-1542	E45S75MSR-1542	E45S75SSR-1542	E45S75WMMR-1542	E45S75WOR-1542	37.75"	42" Wide Upright
E45S75ERR-1548	E45S75PHR-1548	E45S75MSR-1548	E45S75SSR-1548	E45S75WMMR-1548	E45S75WOR-1548	43.75"	48" Wide Upright
E45S75ERR-1560	E45S75PHR-1560	E45S75MSR-1560	E45S75SSR-1560	E45S75WMMR-1560	E45S75WOR-1560	55.75"	60" Wide Upright
E45S75ERR-1572	E45S75PHR-1572	E45S75MSR-1572	E45S75SSR-1572	E45S75WMMR-1572	E45S75WOR-1572	67.75"	72" Wide Upright
16" Deep							
E45S75ERR-1642	E45S75PHR-1642	E45S75MSR-1642	E45S75SSR-1642	E45S75WMMR-1642	E45S75WOR-1642	37.75"	42" Wide Upright
E45S75ERR-1648	E45S75PHR-1648	E45S75MSR-1648	E45S75SSR-1648	E45S75WMMR-1648	E45S75WOR-1648	43.75"	48" Wide Upright
E45S75ERR-1660	E45S75PHR-1660	E45S75MSR-1660	E45S75SSR-1660	E45S75WMMR-1660	E45S75WOR-1660	55.75"	60" Wide Upright
E45S75ERR-1672	E45S75PHR-1672	E45S75MSR-1672	E45S75SSR-1672	E45S75WMMR-1672	E45S75WOR-1672	67.75"	72" Wide Upright
18" Deep							
E45S75ERR-1842	E45S75PHR-1842	E45S75MSR-1842	E45S75SSR-1842	E45S75WMMR-1842	E45S75WOR-1842	37.75"	42" Wide Upright
E45S75ERR-1848	E45S75PHR-1848	E45S75MSR-1848	E45S75SSR-1848	E45S75WMMR-1848	E45S75WOR-1848	43.75"	48" Wide Upright
E45S75ERR-1860	E45S75PHR-1860	E45S75MSR-1860	E45S75SSR-1860	E45S75WMMR-1860	E45S75WOR-1860	55.75"	60" Wide Upright
E45S75ERR-1872	E45S75PHR-1872	E45S75MSR-1872	E45S75SSR-1872	E45S75WMMR-1872	E45S75WOR-1872	67.75"	72" Wide Upright

Envision 4.5 - 1" Thick Shelving with Cutouts for Rear Rod

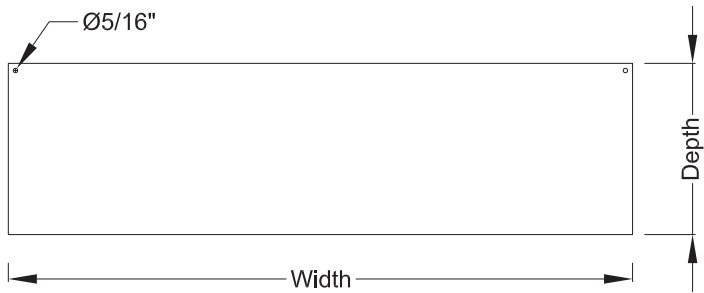

- These shelves to be used with Envision 4.5 brackets
- Each part number includes (1) shelf
- These shelves include cutouts for rear rod

Epoxy	Cat. No. Phenolic	Painted Steel	Stainless Steel	Wood - Maple	Wood - Oak	Actual Width	For Use With:
9.5" Deep							
E45S1ERR-9542	E45S1PHR-9542	E45S1MSR-9542	E45S1SSR-9542	E45S1WMR-9542	E45S1WOR-9542	37.75"	42" Wide Upright
E45S1ERR-9548	E45S1PHR-9548	E45S1MSR-9548	E45S1SSR-9548	E45S1WMR-9548	E45S1WOR-9548	43.75"	48" Wide Upright
E45S1ERR-9560	E45S1PHR-9560	E45S1MSR-9560	E45S1SSR-9560	E45S1WMR-9560	E45S1WOR-9560	55.75"	60" Wide Upright
E45S1ERR-9572	E45S1PHR-9572	E45S1MSR-9572	E45S1SSR-9572	E45S1WMR-9572	E45S1WOR-9572	67.75"	72" Wide Upright
12" Deep							
E45S1ERR-1242	E45S1PHR-1242	E45S1MSR-1242	E45S1SSR-1242	E45S1WMR-1242	E45S1WOR-1242	37.75"	42" Wide Upright
E45S1ERR-1248	E45S1PHR-1248	E45S1MSR-1248	E45S1SSR-1248	E45S1WMR-1248	E45S1WOR-1248	43.75"	48" Wide Upright
E45S1ERR-1260	E45S1PHR-1260	E45S1MSR-1260	E45S1SSR-1260	E45S1WMR-1260	E45S1WOR-1260	55.75"	60" Wide Upright
E45S1ERR-1272	E45S1PHR-1272	E45S1MSR-1272	E45S1SSR-1272	E45S1WMR-1272	E45S1WOR-1272	67.75"	72" Wide Upright
13" Deep							
E45S1ERR-1342	E45S1PHR-1342	E45S1MSR-1342	E45S1SSR-1342	E45S1WMR-1342	E45S1WOR-1342	37.75"	42" Wide Upright
E45S1ERR-1348	E45S1PHR-1348	E45S1MSR-1348	E45S1SSR-1348	E45S1WMR-1348	E45S1WOR-1348	43.75"	48" Wide Upright
E45S1ERR-1360	E45S1PHR-1360	E45S1MSR-1360	E45S1SSR-1360	E45S1WMR-1360	E45S1WOR-1360	55.75"	60" Wide Upright
E45S1ERR-1372	E45S1PHR-1372	E45S1MSR-1372	E45S1SSR-1372	E45S1WMR-1372	E45S1WOR-1372	67.75"	72" Wide Upright
15" Deep							
E45S1ERR-1542	E45S1PHR-1542	E45S1MSR-1542	E45S1SSR-1542	E45S1WMR-1542	E45S1WOR-1542	37.75"	42" Wide Upright
E45S1ERR-1548	E45S1PHR-1548	E45S1MSR-1548	E45S1SSR-1548	E45S1WMR-1548	E45S1WOR-1548	43.75"	48" Wide Upright
E45S1ERR-1560	E45S1PHR-1560	E45S1MSR-1560	E45S1SSR-1560	E45S1WMR-1560	E45S1WOR-1560	55.75"	60" Wide Upright
E45S1ERR-1572	E45S1PHR-1572	E45S1MSR-1572	E45S1SSR-1572	E45S1WMR-1572	E45S1WOR-1572	67.75"	72" Wide Upright
16" Deep							
E45S1ERR-1642	E45S1PHR-1642	E45S1MSR-1642	E45S1SSR-1642	E45S1WMR-1642	E45S1WOR-1642	37.75"	42" Wide Upright
E45S1ERR-1648	E45S1PHR-1648	E45S1MSR-1648	E45S1SSR-1648	E45S1WMR-1648	E45S1WOR-1648	43.75"	48" Wide Upright
E45S1ERR-1660	E45S1PHR-1660	E45S1MSR-1660	E45S1SSR-1660	E45S1WMR-1660	E45S1WOR-1660	55.75"	60" Wide Upright
E45S1ERR-1672	E45S1PHR-1672	E45S1MSR-1672	E45S1SSR-1672	E45S1WMR-1672	E45S1WOR-1672	67.75"	72" Wide Upright
18" Deep							
E45S1ERR-1842	E45S1PHR-1842	E45S1MSR-1842	E45S1SSR-1842	E45S1WMR-1842	E45S1WOR-1842	37.75"	42" Wide Upright
E45S1ERR-1848	E45S1PHR-1848	E45S1MSR-1848	E45S1SSR-1848	E45S1WMR-1848	E45S1WOR-1848	43.75"	48" Wide Upright
E45S1ERR-1860	E45S1PHR-1860	E45S1MSR-1860	E45S1SSR-1860	E45S1WMR-1860	E45S1WOR-1860	55.75"	60" Wide Upright
E45S1ERR-1872	E45S1PHR-1872	E45S1MSR-1872	E45S1SSR-1872	E45S1WMR-1872	E45S1WOR-1872	67.75"	72" Wide Upright

Envision 4.5

Envision 4.5 - Bookend Brackets

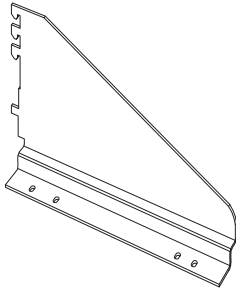

- These brackets to be used with Envision 4.5 uprights
- Sold in pairs

Cat. No.		Depth
Painted Steel	Stainless Steel	
.75" Thick Shelf		
E4SBB75-9	E4SBB75-9S	9"
E4SBB75-12	E4SBB75-12S	12"
E4SBB75-15	E4SBB75-15S	15"
1" Thick Shelf		
E4SBB1-9	E4SBB1-9S	9"
E4SBB1-12	E4SBB1-12S	12"
E4SBB1-15	E4SBB1-15S	15"

Envision 4.5 - Inverted Brackets

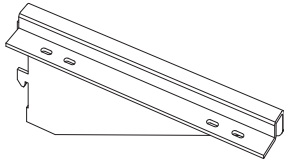

- These brackets to be used with Envision 4.5 uprights
- Sold in pairs

Cat. No.		Depth
Painted Steel	Stainless Steel	
.75" Thick Shelf		
E4SBI75-9	E4SBI75-9S	9"
E4SBI75-12	E4SBI75-12S	12"
E4SBI75-15	E4SBI75-15S	15"
1" Thick Shelf		
E4SBI1-9	E4SBI1-9S	9"
E4SBI1-12	E4SBI1-12S	12"
E4SBI1-15	E4SBI1-15S	15"

Envision 4.5 - Shelf Lip

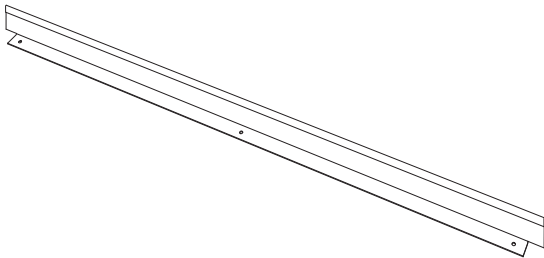

- These shelf lips to be used with Envision 4.5 shelves

Cat. No.		Width
Painted Steel	Stainless Steel	
Shelf Lip Front Mount		
E45SLF-42	E45SLF-42S	37.75"
E45SLF-48	E45SLF-48S	43.75"
E45SLF-60	E45SLF-60S	55.75"
E45SLF-72	E45SLF-72S	67.75"
Shelf Lip Rear Mount		
E45SLR-42	E45SLR-42S	37.75"
E45SLR-48	E45SLR-48S	43.75"
E45SLR-60	E45SLR-60S	55.75"
E45SLR-72	E45SLR-72S	67.75"

Envision 4.5 - Front Shelf Rod

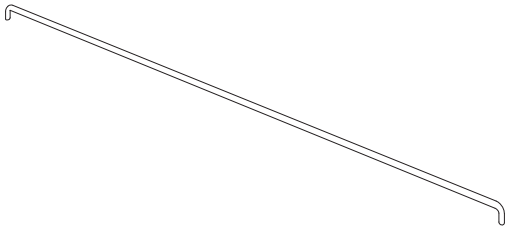

- These shelf rods to be used with Envision 4.5 shelves
- Each part number includes (1) front shelf rod. If purchasing shelf rods for 60" uprights or wider you must order (2) front shelf rods

Cat. No.		Number of Rods	Width
Aluminum	Stainless Steel		
E45SRF-42	E45SRF-42S	1	38.875"
E45SRF-48	E45SRF-48S	1	44.875"
E45SRF-60	E45SRF-60S	2	27.875"
E45SRF-72	E45SRF-72S	2	33.875"

Envision 4.5 - Rear Shelf Rod

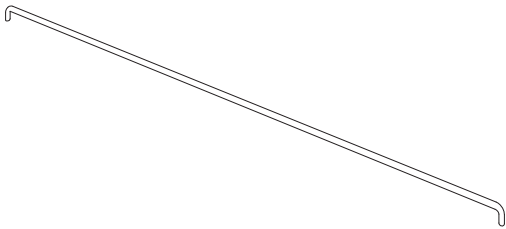

- These shelf rods to be used with Envision 4.5 shelves
- Each part number includes (1) rear shelf rod. If purchasing shelf rods for 60" uprights or wider you must order (2) rear shelf rods

Cat. No.		Number of Rods	Width
Aluminum	Stainless Steel		
E45SRR-42	E45SRR-42S	1	36.75"
E45SRR-48	E45SRR-48S	1	42.75"
E45SRR-60	E45SRR-60S	2	25.75"
E45SRR-72	E45SRR-72S	2	31.75"

Envision 4.5 - Side Shelf Rod

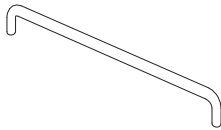

- These shelf rods to be used with Envision 4 shelves

Cat. No.		Number of Rods	Depth
Aluminum	Stainless Steel		
E4SRS-9	E4SRS-9S	1	7"
E4SRS-12	E4SRS-12S	1	10"
E4SRS-15	E4SRS-15S	1	13"

Wall Cabinet Hanger Bars

- Not available for Envision 4.5

Envision 4.5

Envision 4.5 - Cabinet Stop

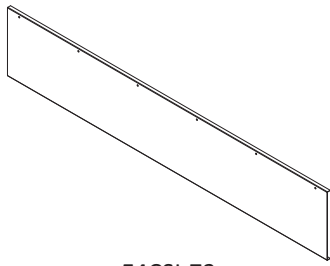

E4CSI-72

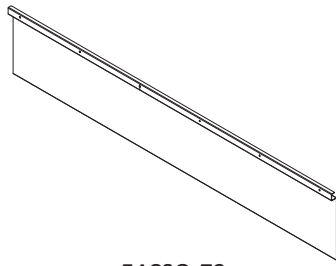

E4CSO-72

- These Cabinet Stops are to be used with Envision 4.5
- They are to prevent mobile cabinet from rolling to far under the work surface

Cat. No.		Actual Width	Width
For Inset Cabinet	For Overlay Cabinet		
E4CSI-42	E4CSO-42		42"
E4CSI-48	E4CSO-48	40.75"	48"
E4CSI-60	E4CSO-60	52.75"	60"
E4CSI-72	E4CSO-72	64.75"	72"

Envision 4.5 - Stabilizer Bar

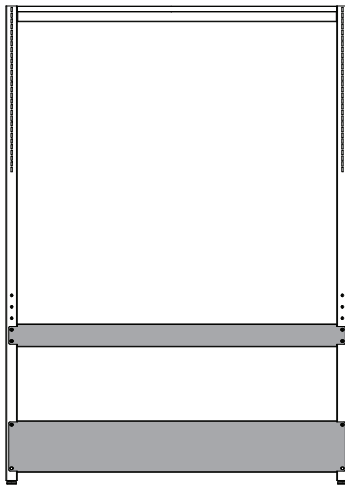

Elevation of Stabilizer Bars

- These Stabilizer Bars are to be used with Envision 4.5

Cat. No.		Width
Lower Brace	Upper Brace	
E4SBRL-42	E4SBRU-42	42"
E4SBRL-48	E4SBRU-48	48"
E4SBRL-60	E4SBRU-60	60"
E4SBRL-72	E4SBRU-72	72"

Envision 4.5 - Table Support Clamps



- These are to be used with Envision 4.5
- Kit of 2 with hardware
- Use for all tables on backside of 6" uprights

Cat. No.	Type
E4TSC	Table Support Clamps

LED Task Lighting for Envision 4.5



- Touch and hold continuous dimming and 10 hour automatic turnoff
- Units with (1) light include: (1) LED task light, magnetic angle mount that allows for up to 25° adjustment, 60 watt power supply with magnetic mount and 6' white cord
- Units with (2) lights include: (2) LED task light, magnetic angle mount that allows for up to 25° adjustment, 60 watt power supply with magnetic mount, 6' white cord, and 1 interlink cord to connect lights
- 60 watt power supply with magnetic mount and 6' white cord
- Made with anodized aluminum
- Lasts up to 50,000 hours

Cat. No.	Quantity of Lights	Actual Width	For use with:
Single Sided			
TL17-LED	1	17"	42" wide Table
TL17-LED	1	17"	48" wide Table
TL34-LED	2	17"	60" wide Table
TL34-LED	2	17"	72" wide Table
Double Sided			
TL17-LEDDBL	2	17"	42" wide Table
TL17-LEDDBL	2	17"	48" wide Table
TL34-LEDDBL	4	17"	60" wide Table
TL34-LEDDBL	4	17"	72" wide Table

Envision 4.5 Electrical

Envision 4.5 Electrical for 6" upright

Sample: E45W6I $\frac{\quad}{1} \frac{\quad}{2} \frac{\quad}{3}$ - (width of upright)

Space 1 Options:

G = Grey
I = Ivory
W = White

Space 2 Options:

4 = 4' cord above upright
6 = 6' cord above upright

Space 3 Options:

(Blank) = Standard outlet
G - GFI outlet

Cat. No.	Description	Width Options
E45W6I ___ - ___	2 circuit, 1 plug, 6 electrical outlets	42", 48", 60", 72"
E45W6J ___ - ___	2 circuit, 2 plug, 6 electrical outlets	42", 48", 60", 72"
E45W6K ___ - ___	3 circuit, 2 plug, 6 electrical outlets	42", 48", 60", 72"
E45W6L ___ - ___	4 circuit, 2 plug, 6 electrical outlets	42", 48", 60", 72"

Example: E45W6IG4G-48

Envision 4.5 Wiring for 6" upright, Grey, 2 circuit, 1 plug, 6 GFI outlets, for 48" wide upright

Note: All electrical components are UL Labeled and pre-wiring is UL Listed

Envision 4.5 Data for 6" upright

Sample: E45D6 $\frac{\quad}{1} \frac{\quad}{2} \frac{\quad}{3}$ - (width of upright)

Space 1 Options:

2 = Double Data
4 = Quad Data

Space 2 Options:

G = Light Grey

Space 3 Options:

4 = 4' cord above upright
6 = 6' cord above upright

Cat. No.	Description	Width Options
E45D6____-__	Double Data Outlet	42", 48", 60", 72"
E45D6____-__	Quad Data Outlet	42", 48", 60", 72"

Example: E45D62G4-48

Envision 4.5 Data for 6" upright, Light Grey, Double Data Outlet, for 48" wide upright

Note: Data is CAT-5E

Envision Plumbing

Single Brass Ball Valve Turret

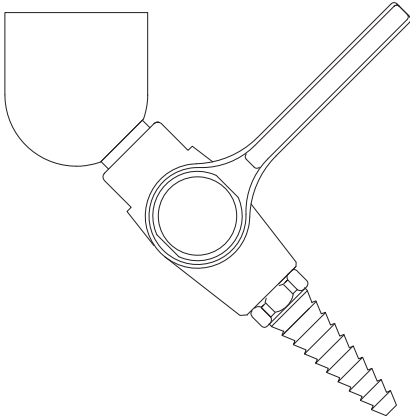

- Single Brass Ball Valve Turret
- To be used with any Envision Upright

Cat. No.		Service	Color
Left Hand	Right Hand		
E3SBVL-K1	E3SBVR-K1	Helium	Black
E3SBVL-K2	E3SBVR-K2	Air	Orange
E3SBVL-K4	E3SBVR-K4	Vacuum	Yellow
E3SBVL-K5	E3SBVR-K5	Gas	Blue
E3SBVL-K6	E3SBVR-K6	Natural Gas	Blue
E3SBVL-K7	E3SBVR-K7	Argon	Violet
E3SBVL-K8	E3SBVR-K8	Nitrogen	Brown

Single Brass Instrument (Needle) Valve Turret

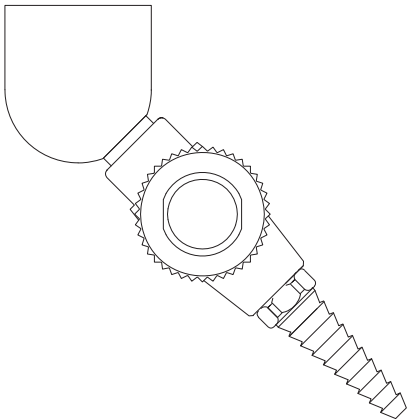

- Single Brass Instrument (Needle) Valve Turret
- To be used with any Envision Upright

Cat. No.		Service	Color
Left Hand	Right Hand		
E3SIVL-K1	E3SIVR-K1	Helium	Black
E3SIVL-K2	E3SIVR-K2	Air	Orange
E3SIVL-K4	E3SIVR-K4	Vacuum	Yellow
E3SIVL-K5	E3SIVR-K5	Gas	Blue
E3SIVL-K6	E3SIVR-K6	Natural Gas	Blue
E3SIVL-K7	E3SIVR-K7	Argon	Violet
E3SIVL-K8	E3SIVR-K8	Nitrogen	Brown

Double Brass Ball Valve Turret

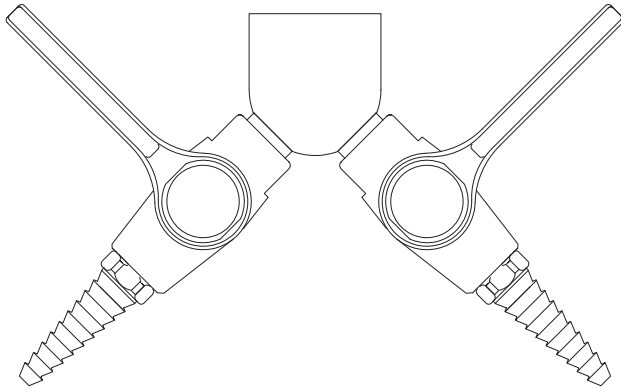

- Double Brass Ball Valve Turret
- To be used with any Envision Upright

Cat. No.	Service	Color
E3DBV-K1	Helium	Black
E3DBV-K2	Air	Orange
E3DBV-K4	Vacuum	Yellow
E3DBV-K5	Gas	Blue
E3DBV-K6	Natural Gas	Blue
E3DBV-K7	Argon	Violet
E3DBV-K8	Nitrogen	Brown

Double Brass Instrument (Needle) Valve Turret

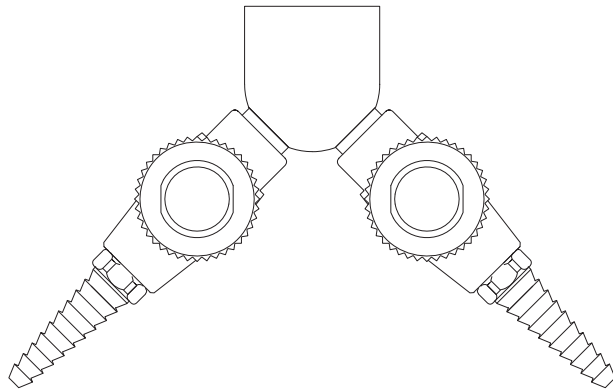

- Double Brass Instrument (Needle) Valve Turret
- To be used with any Envision Upright

Cat. No.	Service	Color
E3DIV-K1	Helium	Black
E3DIV-K2	Air	Orange
E3DIV-K4	Vacuum	Yellow
E3DIV-K5	Gas	Blue
E3DIV-K6	Natural Gas	Blue
E3DIV-K7	Argon	Violet
E3DIV-K8	Nitrogen	Brown

Plumbing Cutout Plug

- When not using plumbing fixture, a Plumbing Cutout Plug is needed

Cat. No.	Color
E3PP	Black

Envision Plumbing

For Pre-piping, contact your ICI Representative

Reinforced PVC Flexible Hoses



- For use with 3" or 6" Envision Upright
- For non-burning gases
- Color-coded hoses available, contact your ICI representative

Details:

- Material: Reinforced PVC
- O.D.:
- I.D.:
- FNPT: 3/8"
- MNPT: 3/8"

Cat. No.	Color
48" Long above the upright	
E3PRP5W4	White
72" Long above the upright	
E3PRP5W6	White

Braided Stainless Steel Flexible Hoses



- For use with 3" or 6" Envision Upright
- For natural and reactive gases
- Color-coded hoses available, contact your ICI representative

Details:

- Material: Braided Stainless Steel
- O.D.:
- I.D.:
- FNPT: 3/8"
- MNPT: 3/8"

Cat. No.	Color
48" Long above the upright	
E3PSGW4	Stainless Steel
72" Long above the upright	
E3PSGW6	Stainless Steel

Hose/Wire Management System



Cat. No.	Length	Color
E3HM-48	48"	Black
E3HM-72	72"	Black

Male Quick Connection at the End of the Hose



Details:

- Material: Brass
- 3/8" MNPT

Cat. No.	Service	Color
E3PFWQPM-K1	Helium	Black
E3PFWQPM-K2	Air	Orange
E3PFWQPM-K4	Vacuum	Yellow
E3PFWQPM-K5	Gas	Blue
E3PFWQPM-K6	Natural Gas	Blue
E3PFWQPM-K7	Argon	Violet
E3PFWQPM-K8	Nitrogen	Brown

For custom configurations, contact your ICI representative.

Overhead Service Panel for Envision

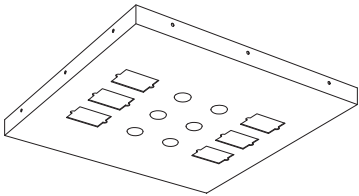

- See image for cut out configuration
- (6) J Box Cutouts
- (6) Plumbing Cutouts

Cat. No.	Dimensions
E3CP2424D	24" x 24"

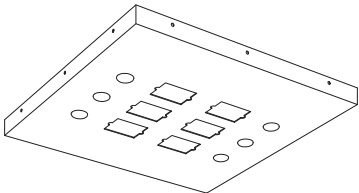

- See image for cut out configuration
- (6) J Box Cutouts
- (6) Plumbing Cutouts

Cat. No.	Dimensions
E3CP2424F	24" x 24"

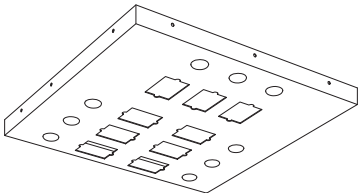

- See image for cut out configuration
- (9) J Box Cutouts
- (9) Plumbing Cutouts

Cat. No.	Dimensions
E3CP2424G	24" x 24"

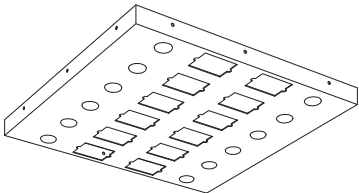

- See image for cut out configuration
- (12) J Box Cutouts
- (12) Plumbing Cutouts

Cat. No.	Dimensions
E3CP2424H	24" x 24"

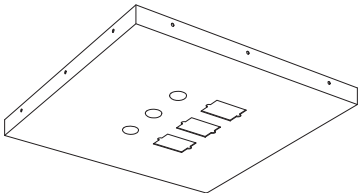

- See image for cut out configuration
- (3) J Box Cutouts
- (3) Plumbing Cutouts

Cat. No.	Dimensions
E3CP2424V	24" x 24"

Envision Accessories

Quick Connect Outlets for Ceilings Panels

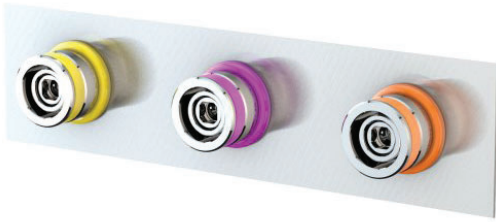

- Envision Plumbing Fitting Brass 3/8" MNPT to QC Body QCFL-B-3M-K (for ceiling panel)

Cat. No.	Type
E3PFWQBM-K1	Helium
E3PFWQBM-K2	Air
E3PFWQBM-K4	Vacuum
E3PFWQBM-K5	Gas
E3PFWQBM-K6	Natural Gas
E3PFWQBM-K7	Argon
E3PFWQBM-K8	Nitrogen
E3CPP	Ceiling Panel Plug Cover

Junction Box

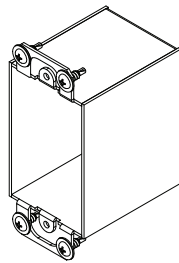

Cat. No.	Type
E3CPJB	J-Box

Electrical Box Assemblies

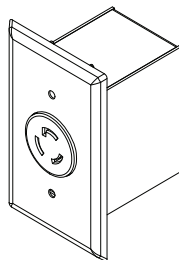

- Includes: Junction box, electrical outlet, stainless steel cover plate

Cat. No.	Type
E3CPL5-KIT	L5-20R
E3CPL14-KIT	L14-20R

Data Box Assemblies

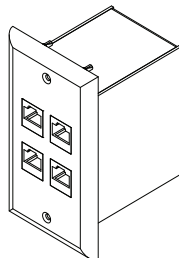

- Includes: Junction box, data outlet, stainless steel cover plate
- CAT-5E

Cat. No.	Type
E3CPD2-KIT	2 Data Outlets
E3CPD4-KIT	4 Data Outlets
E3CPD6-KIT	6 Data Outlets

Modesty Panel

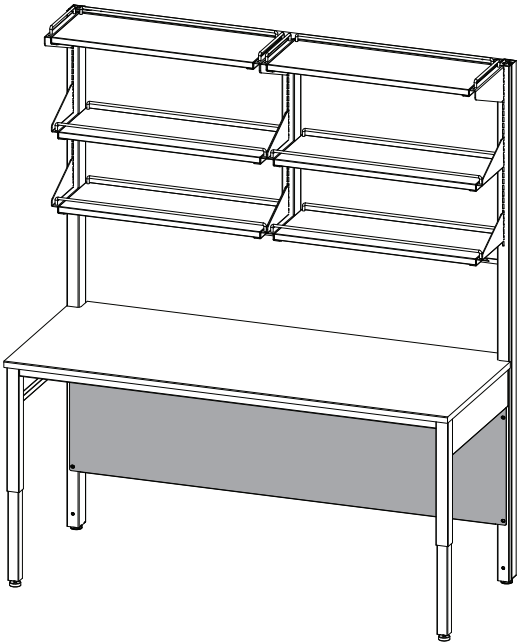

- Steel modesty panel, color to match uprights color

Cat. No.	For use with:
E3MP61A-2342	42" wide uprights
E3MP61A-2348	48" wide uprights
E3MP61A-2360	60" wide uprights
E3MP61A-2372	72" wide uprights
E3MP61A-2384	84" wide uprights
E3MP61A-2396	96" wide uprights

Tack/Marker Board

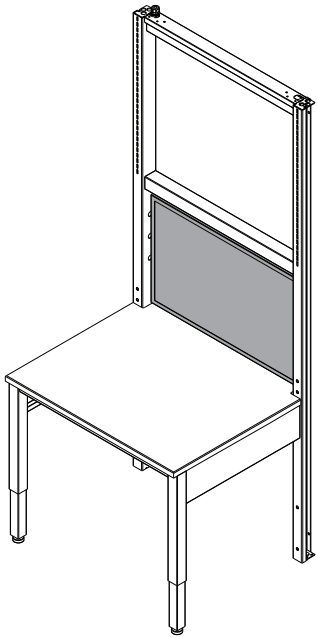

- Tack/Marker board is one sided
- Can not be used with plumbing fixtures
- Only can be used with Envision 3.0 and 4.0

Cat. No.		For use with:
Tack Board	Marker Board	
E3LP61C-2042	E3LP61M-2042	42" wide uprights
E3LP61C-2048	E3LP61M-2048	48" wide uprights
E3LP61C-2060	E3LP61M-2060	60" wide uprights
E3LP61C-2072	E3LP61M-2072	72" wide uprights
E3LP61C-2084	E3LP61M-2084	84" wide uprights
E3LP61C-2096	E3LP61M-2096	96" wide uprights

Envision Accessories

Keyboard Tray

Cat. No.	Type
KBTMP	Keyboard Tray with Mouse Pad

Monitor Arm

Cat. No.	Type
ENV-MA	Monitor Arm

CPU Holder

Cat. No.	Type
ENV-CPUH	CPU Holder

Envision Upright Configurator

Envision 3.0/4.0 - 3" Core - Single Sided

Upright Style

- Envision 3.0
- Envision 4.0

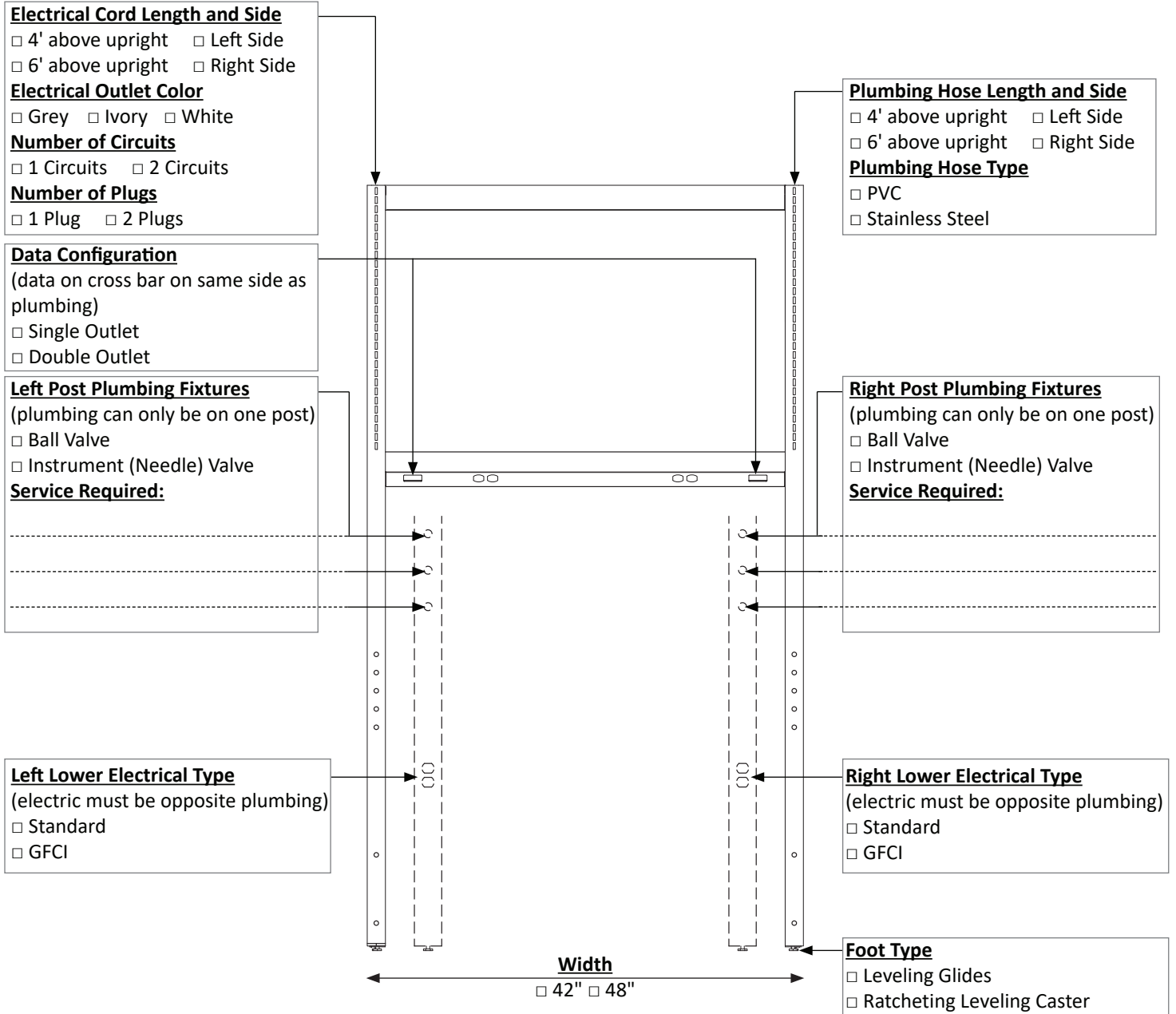

Envision Upright Configurator

Envision 3.0/4.0 - 3" Core - Single Sided

Upright Style

- Envision 3.0
- Envision 4.0

Electrical Cord Length and Side

- 4' above upright Left Side
- 6' above upright Right Side

Electrical Outlet Color

- Grey Ivory White

Number of Circuits

- 1 Circuits 2 Circuits 4 Circuits

Number of Plugs

- 1 Plug 2 Plugs

Data Configuration

(data on cross bar on same side as plumbing)

- Single Outlet
- Double Outlet

Left Post Plumbing Fixtures

(plumbing can only be on one post)

- Ball Valve
- Instrument (Needle) Valve

Service Required:

----->

----->

----->

Left Lower Electrical Type

(electric must be opposite plumbing)

- Standard
- GFCI

Plumbing Hose Length and Side

- 4' above upright Left Side
- 6' above upright Right Side

Plumbing Hose Type

- PVC
- Stainless Steel

Right Post Plumbing Fixtures

(plumbing can only be on one post)

- Ball Valve
- Instrument (Needle) Valve

Service Required:

----->

----->

----->

Right Lower Electrical Type

(electric must be opposite plumbing)

- Standard
- GFCI

Foot Type

- Leveling Glides
- Ratcheting Leveling Caster

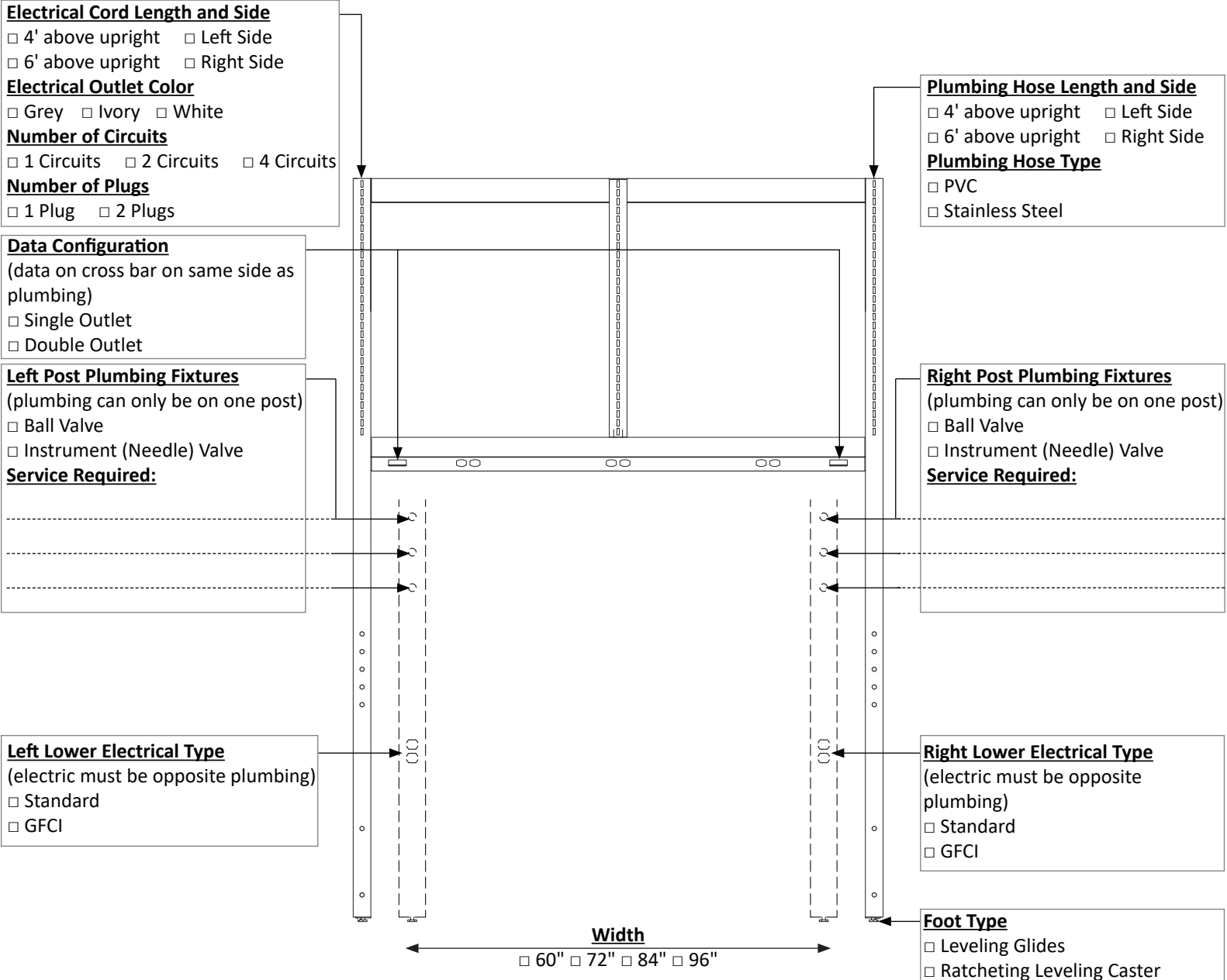

Envision Upright Configurator

Envision 3.0/4.0 - 6" Core - Double Sided

Upright Style

- Envision 3.0
- Envision 4.0

Electrical Cord Length and Side

- 4' above upright Left Side
- 6' above upright Right Side

Electrical Outlet Color

- Grey Ivory White

Number of Circuits

- 1 Circuits 2 Circuits 4 Circuits

Number of Plugs

- 1 Plug 2 Plugs

Data Configuration

(data on cross bar on same side as plumbing)

- Single Outlet
- Double Outlet

Plumbing Hose Length and Side

- 4' above upright Left Side
- 6' above upright Right Side

Plumbing Hose Type

- PVC
- Stainless Steel

Post Plumbing Fixtures

(plumbing can only be on one post)

- Ball Valve
- Instrument (Needle) Valve

Service Required:

Lower Electrical Type

(electric must be opposite plumbing)

- Standard
- GFCI

Foot Type

- Leveling Glides
- Ratcheting Leveling Caster

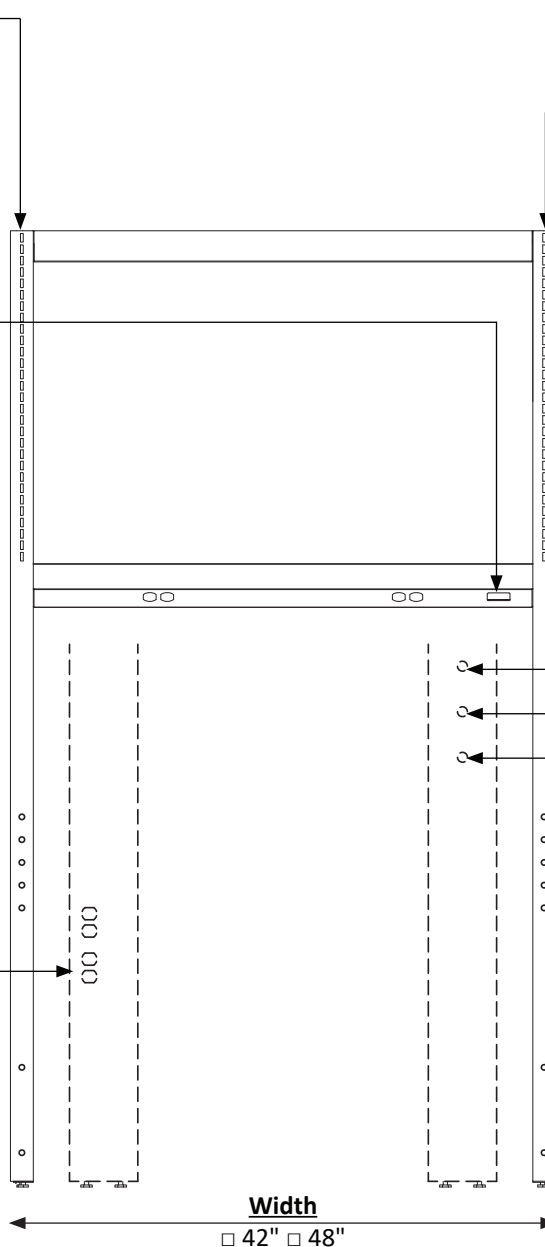

Note: 6" uprights are ambidextrous. Plumbing is only on one side.

Envision Upright Configurator

Envision 3.0/4.0 - 6" Core - Double Sided

Upright Style

- Envision 3.0
- Envision 4.0

Electrical Cord Length and Side

- 4' above upright Left Side
- 6' above upright Right Side

Electrical Outlet Color

- Grey Ivory White

Number of Circuits

- 1 Circuits 2 Circuits 4 Circuits

Number of Plugs

- 1 Plug 2 Plugs

Data Configuration

(data on cross bar on same side as plumbing)

- Single Outlet
- Double Outlet

Plumbing Hose Length and Side

- 4' above upright Left Side
- 6' above upright Right Side

Plumbing Hose Type

- PVC
- Stainless Steel

Post Plumbing Fixtures

(plumbing can only be on one post)

- Ball Valve
- Instrument (Needle) Valve

Service Required:

Lower Electrical Type

(electric must be opposite plumbing)

- Standard
- GFCI

Foot Type

- Leveling Glides
- Ratcheting Leveling Caster

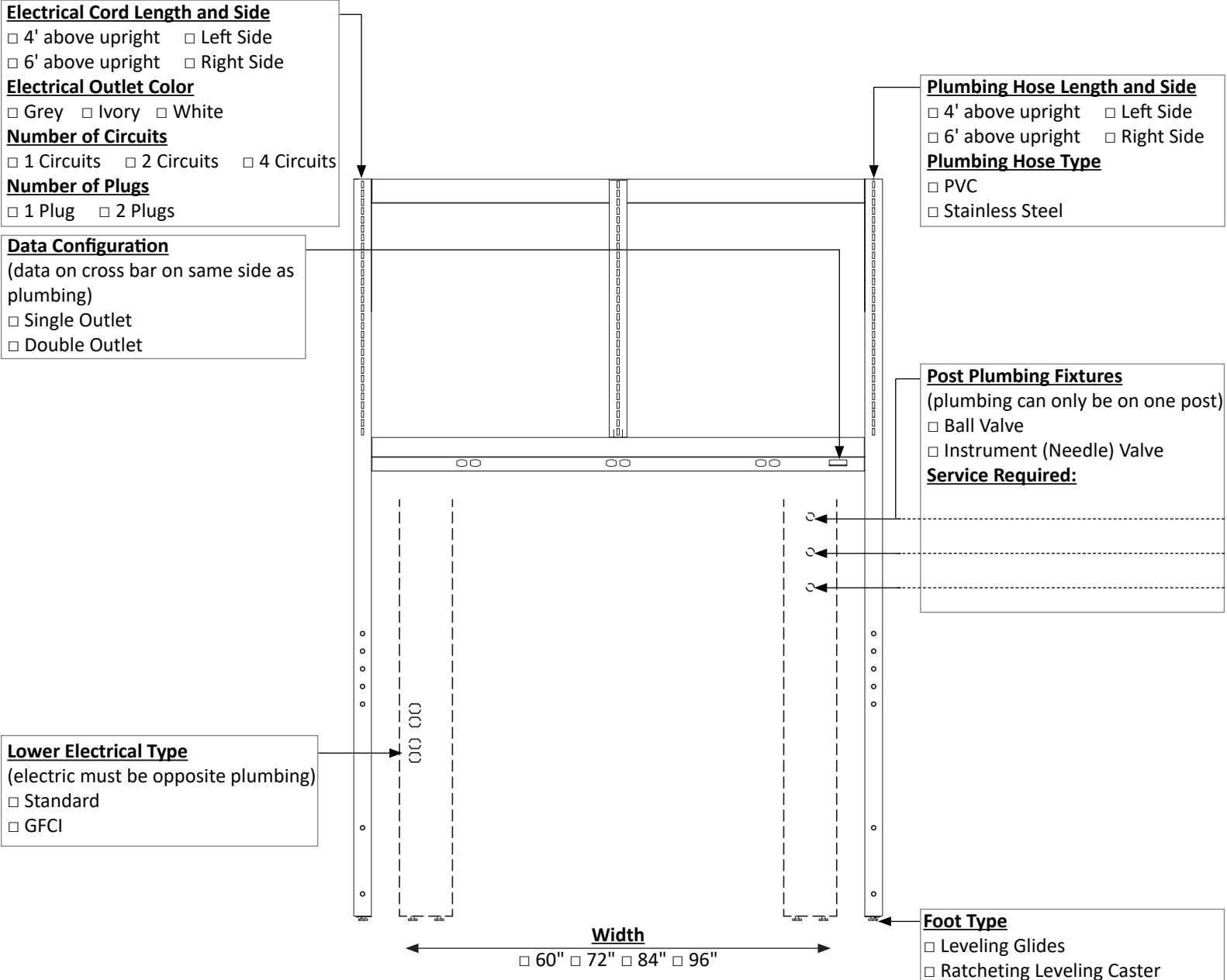

Note: 6" uprights are ambidextrous. Plumbing is only on one side.

Envision Upright Configurator

Envision 3.5/4.5 - 6" Core - Double Sided

Upright Style

- Envision 3.5
- Envision 4.5

Electrical Cord Length and Side

- 4' above upright Left Side
- 6' above upright Right Side

Electrical Outlet Color

- Grey Ivory White

Number of Circuits

- 2 Circuits 3 Circuits 4 Circuits

Number of Plugs

- 1 Plug 2 Plugs

Plumbing Hose Length and Side

- 4' above upright Left Side
- 6' above upright Right Side

Plumbing Hose Type

- PVC
- Stainless Steel

Post Plumbing Fixtures
(plumbing can only be on one post)

- Ball Valve
- Instrument (Needle) Valve

Service Required:

Data Configuration
(data on upright on opposite side as plumbing)

- Double Outlet
- Quad Outlet

Lower Electrical Type
(electric must be opposite plumbing)

- Standard
- GFCI

Foot Type

- Leveling Glides
- Ratcheting Leveling Caster

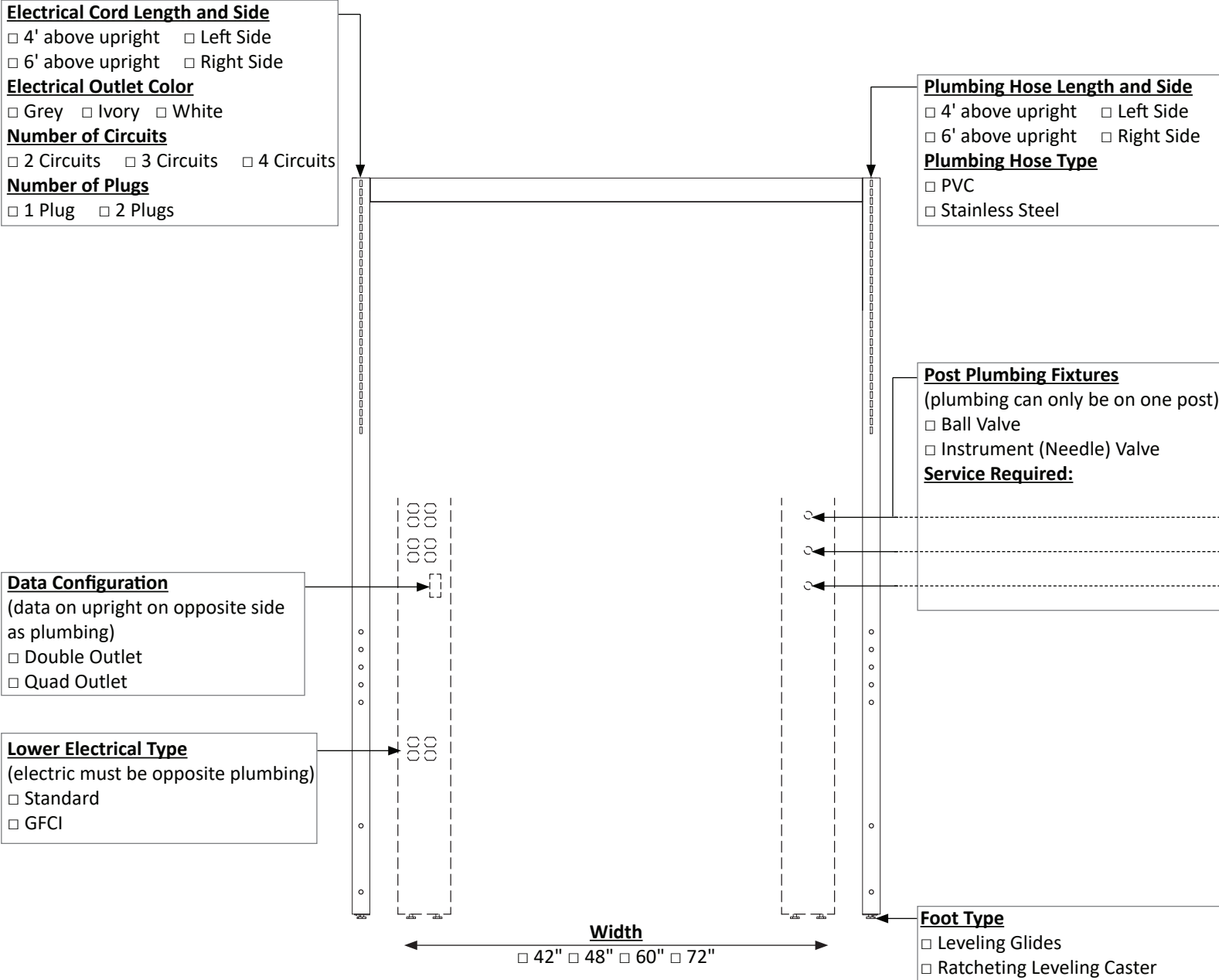

Note: 6" uprights are ambidextrous. Plumbing is only on one side.

FlexCore Mobile Cart

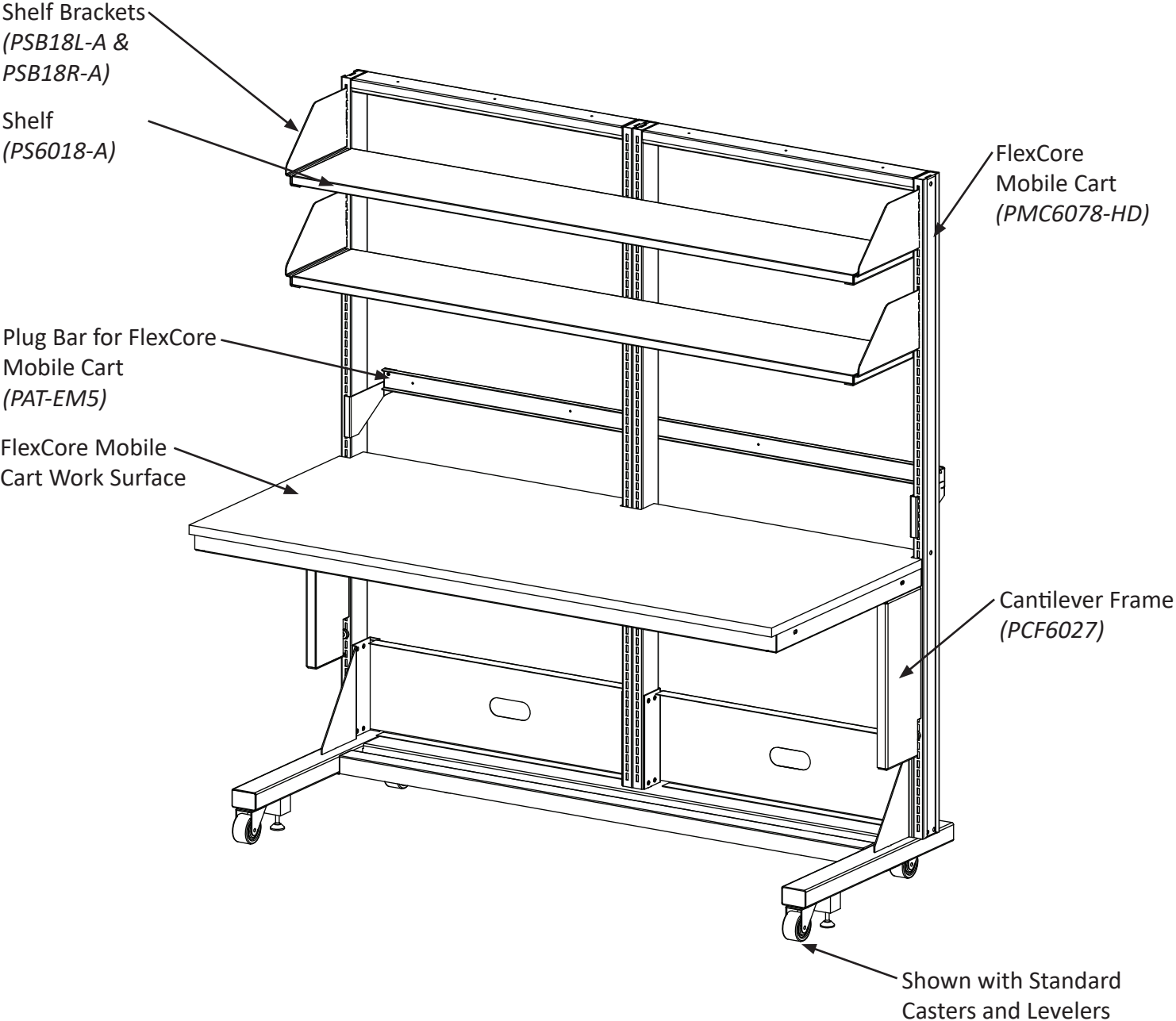

FlexCore Mobile Cart

FlexCore Mobile Cart - Standard Casters

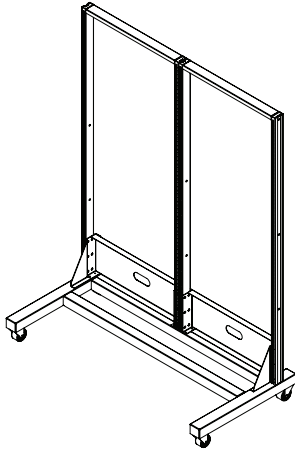

- Replace "P" with and "S" for Stainless Steel
- Note: Carts over 48" wide have a center vertical post
- Weight Capacity up to 900 lbs.

Cat. No.		Width
36" Tall	78" Tall	
PMC2436	PMC2478	24"
PMC3036	PMC3078	30"
PMC3636	PMC3678	36"
PMC4236	PMC4278	42"
PMC4836	PMC4878	48"
PMC5436	PMC5478	54"
PMC6036	PMC6078	60"
PMC6636	PMC6678	66"
PMC7236	PMC7278	72"

FlexCore Mobile Cart - Standard Casters and Levelers

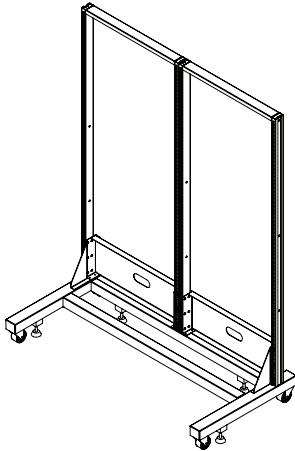

- Replace "P" with and "S" for Stainless Steel
- Note: Carts over 48" wide have a center vertical post

Cat. No.		Width
36" Tall	78" Tall	
PMC2436-HD	PMC2478-HD	24"
PMC3036-HD	PMC3078-HD	30"
PMC3636-HD	PMC3678-HD	36"
PMC4236-HD	PMC4278-HD	42"
PMC4836-HD	PMC4878-HD	48"
PMC5436-HD	PMC5478-HD	54"
PMC6036-HD	PMC6078-HD	60"
PMC6636-HD	PMC6678-HD	66"
PMC7236-HD	PMC7278-HD	72"

FlexCore Mobile Cart - Leveling Casters

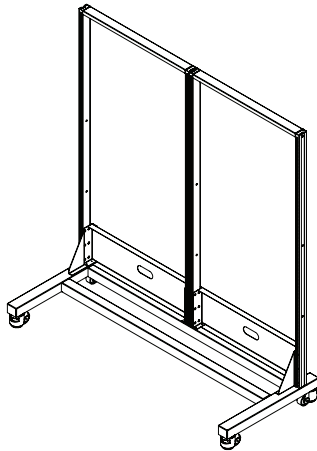

- Replace "P" with and "S" for Stainless Steel
- Note: Carts over 48" wide have a center vertical post

Cat. No.		Width
36" Tall	78" Tall	
PMC2436-HDZ	PMC2478-HDZ	24"
PMC3036-HDZ	PMC3078-HDZ	30"
PMC3636-HDZ	PMC3678-HDZ	36"
PMC4236-HDZ	PMC4278-HDZ	42"
PMC4836-HDZ	PMC4878-HDZ	48"
PMC5436-HDZ	PMC5478-HDZ	54"
PMC6036-HDZ	PMC6078-HDZ	60"
PMC6636-HDZ	PMC6678-HDZ	66"
PMC7236-HDZ	PMC7278-HDZ	72"

FlexCore Mobile Cart

Plug Bar for FlexCore Mobile Cart

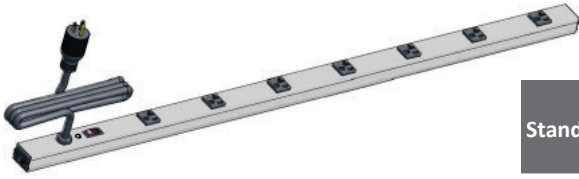

- Plug Mold for FlexCore Mobile Cart includes brackets and metal bar for plug bar to attach to FlexCore Mobile Cart
- 6' cord

Cat. No.		For use with:	Actual Outlet Strip Length	Number of Outlets
Standard 20 amp Plug	Twist-to-Lock 20 amp Plug			
PAT-EM4	PAT-EM4TL	48" wide Table	42"	7
PAT-EM5	PAT-EM5TL	60" wide Table	48"	8
PAT-EM6	PAT-EM6TL	72" wide Table	60"	10
PAT-EM7	PAT-EM7TL	84" with Table	70"	10
PAT-EM8	PAT-EM8TL	96" wide Table	70"	10

Front Support Bracket



- Front Support Bracket for Cantilever Frame
- Part Number includes (2) Brackets

Cat. No.	Type
PCSBA	(2) Front Support Bracket

FlexCore Wall Rail Details

The FlexCore Wall Rails provide a modular system capable of supporting a variety of equipment. While primarily intended to support shelving, wall cabinets and cantilever frames may also be used in conjunction with the Wall Rail system. The vertical rails can be located anywhere along the horizontal rails in 6" increments. The weight capacity of the FlexCore Wall Rail system is limited to 720 lbs*.

* use this weight limit as a guideline for supplied materials. Overall performance will be affected by wall construction, substrate, screw type and live loads. DOES NOT APPLY TO VERTICAL RAILS WITH NO HOOKS.

Wall Rail Example Detail

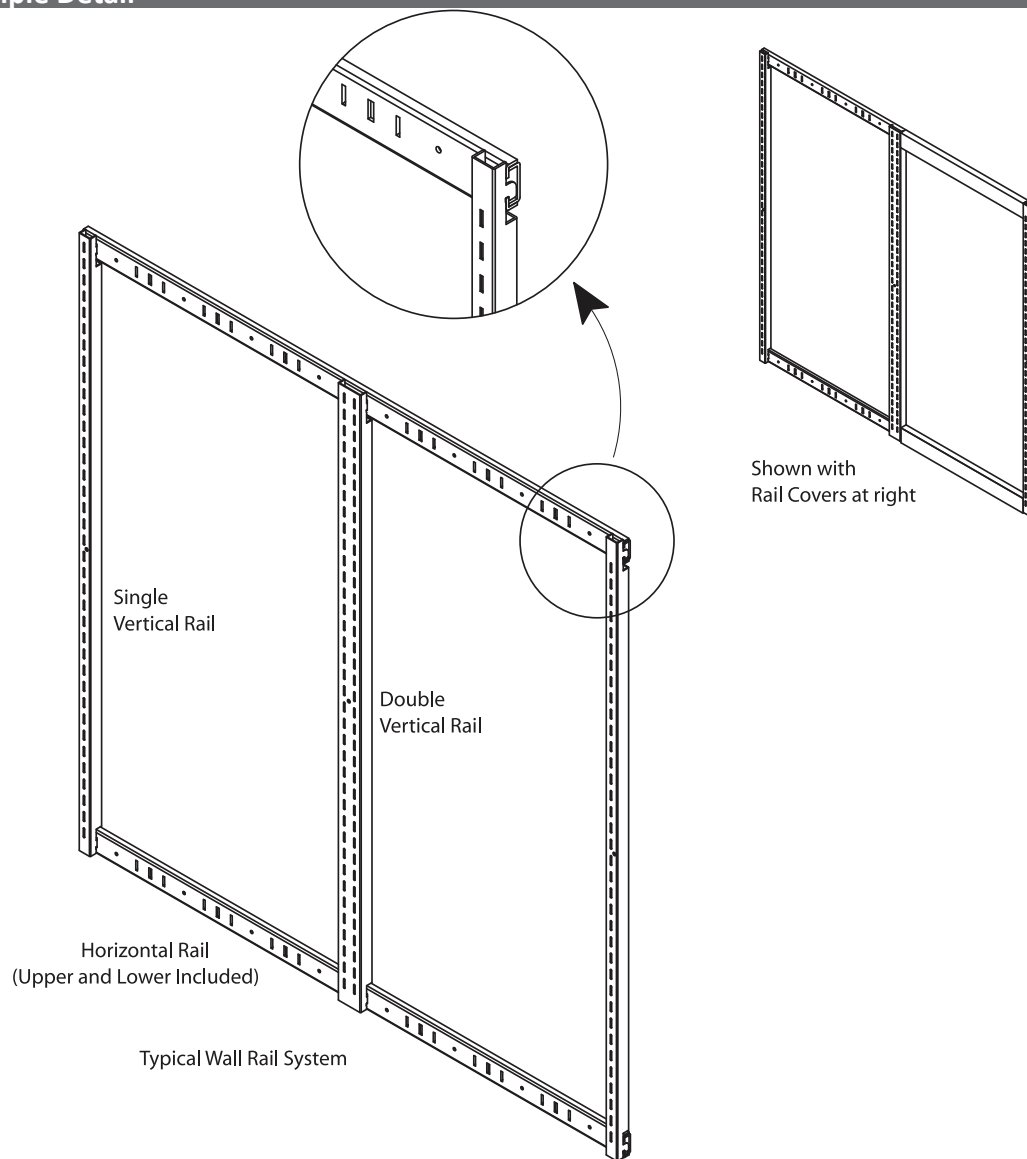

FlexCore Vertical Wall Rail Detail

Installer Notes: Secure the top horizontal rail and hang the vertical rail from it. Use the vertical rail as a quick gauge for locating the lower horizontal rail. The center screw on the vertical rails may be omitted if frequent shelf reconfiguration is anticipated. In high load or traffic areas where the shelf configuration is relatively fixed, a #10 flat-head screw is recommended, length and type are determined by wall material and construction.*

Note: Two single vertical rails side by side are dimensionally identical to one double vertical rail.

*Due to a wide variance in wall strapping materials, screws are NOT supplied. Consult the specifications or the Construction Manager for required type of screw for your project.

Single Vertical Rail Detail

Double Vertical Rail Detail

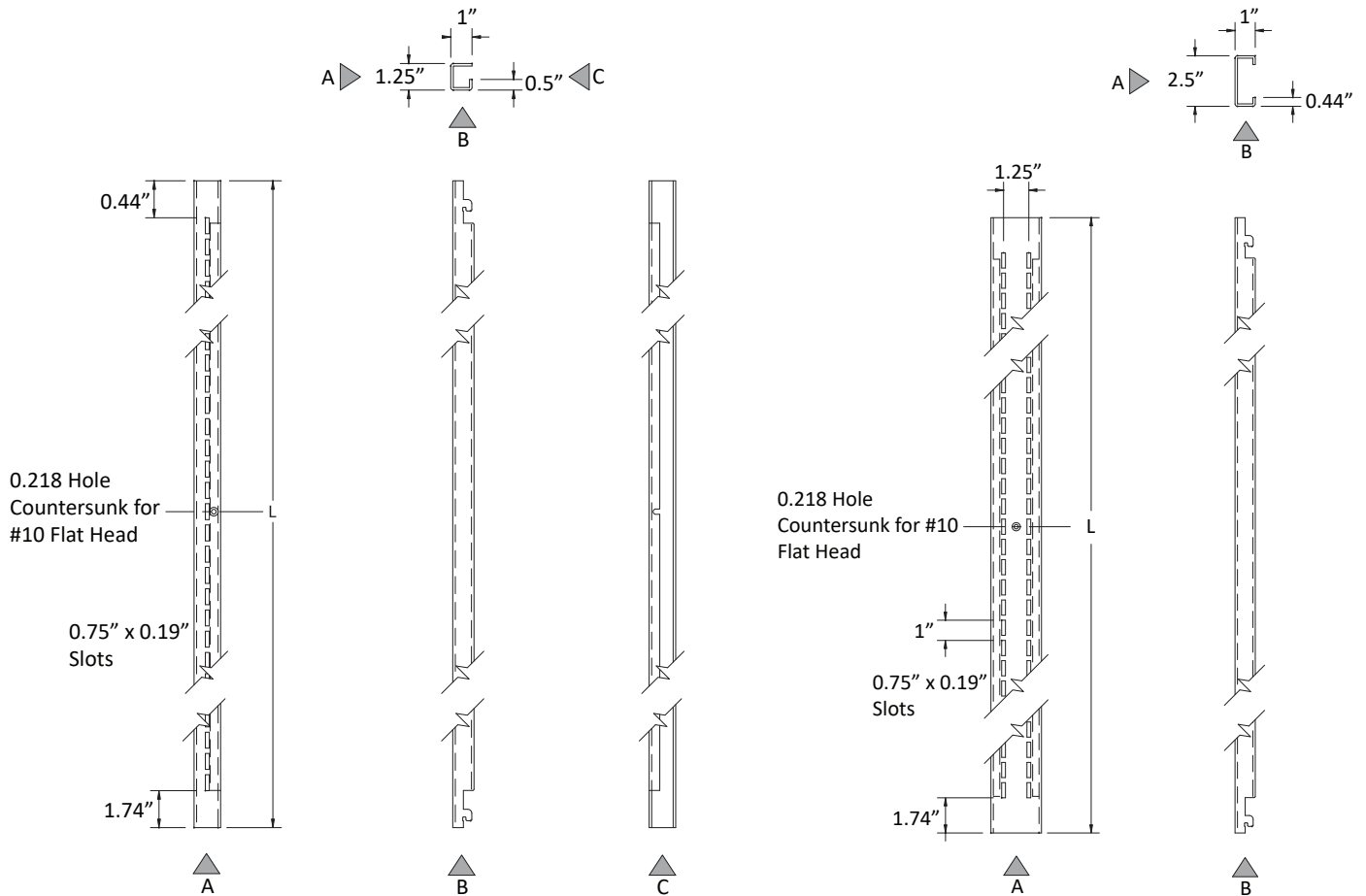

FlexCore Horizontal Wall Rail Detail

Installer Notes: Secure the wall member to the wall using one #8 drive screw through one leveling hole, level the member and secure the opposite end using a second #8 drive screw. Place the horizontal standard over the wall member and secure to strapping using #10 screws, passing through both the standard and the wall member. When curring Horizontal Standards to a particular length, cut through the center of one of the wide slots, this allows it to be used as "standard".

Note: the notch at the end of the standard is 1/2 of a wide slot, so two 24" standards work exactly like one 48" standard.

Due to a wide variance in wall and strapping materials, screws are NOT supplied. Consult the specifications or the Construction Manager for required type of screw for your project.

Horizontal Wall Rail Detail

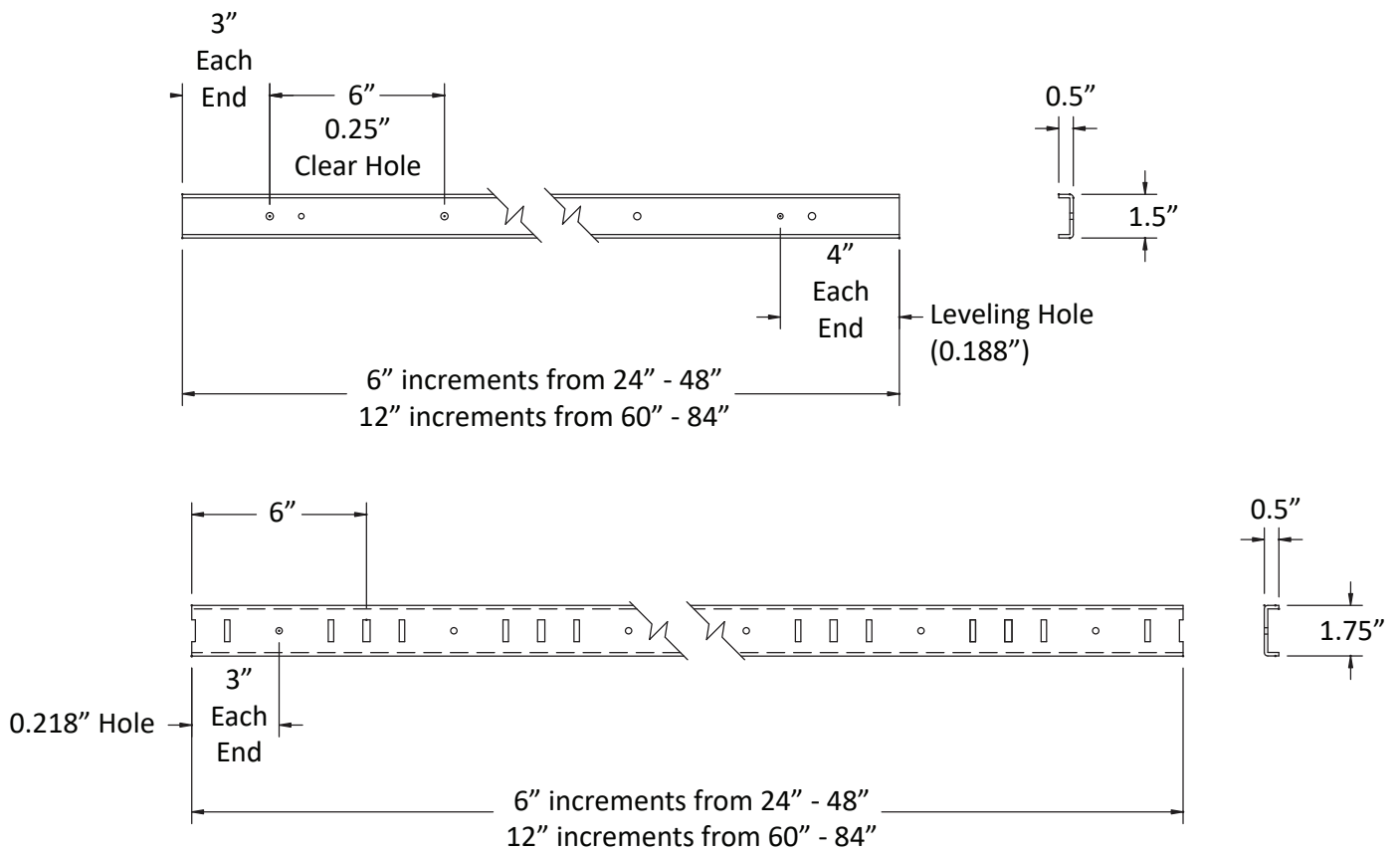

FlexCore Wall Rails

Single Vertical Rails



- Single vertical wall rails are sold individually
- Replace "P" with a "S" for Stainless Steel
- If "No Hooks" is selected, additional hole is included in the standard
- No Hook options is designed for surface mounted

Cat. No.		Length
With Hooks	No Hooks	
PVRS24	PVRS24-NH	24"
PVRS30	PVRS30-NH	30"
PVRS36	PVRS36-NH	36"
PVRS42	PVRS42-NH	42"
PVRS48	PVRS48-NH	48"
PVRS72	PVRS72-NH	72"
PVRS84	PVRS84-NH	84"

Double Vertical Rails



- Double vertical wall rails are sold individually
- Replace "P" with a "S" for Stainless Steel
- If "No Hooks" is selected, additional hole is included in the standard
- No Hook options is designed for surface mounted

Cat. No.		Length
With Hooks	No Hooks	
PVRD24	PVRD24-NH	24"
PVRD30	PVRD30-NH	30"
PVRD36	PVRD36-NH	36"
PVRD42	PVRD42-NH	42"
PVRD48	PVRD48-NH	48"
PVRD72	PVRD72-NH	72"
PVRD84	PVRD84-NH	84"

Horizontal Rails

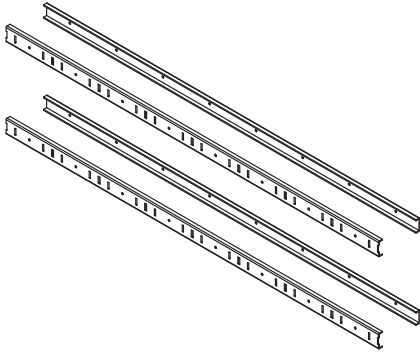

- Horizontal Rails are sold in pairs (upper rail and lower rail)
- Replace "P" with a "S" for Stainless Steel

Cat. No.	Length
PHR24	24"
PHR30	30"
PHR36	36"
PHR42	42"
PHR48	48"
PHR54	54"
PHR60	60"
PHR66	66"
PHR72	72"
PHR84	84"

Horizontal Rail Covers

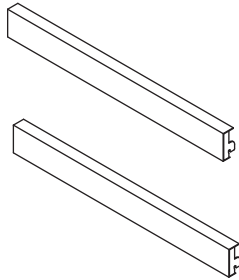

- Horizontal Rail Covers are sold in pairs
- Replace "P" with a "S" for Stainless Steel

Cat. No.	Length
PRC24	24"
PRC30	30"
PRC36	36"
PRC42	42"
PRC48	48"
PRC54	54"
PRC60	60"
PRC66	66"
PRC72	72"
PRC84	84"

FlexCore Frame Assembly

FlexCore Laboratory Solutions

In business since 1943, ICI is a recognized leader in the laboratory furniture industry; and now, our FlexCore adaptable furniture system allows almost limitless possibilities. From traditional modular casework, to docking mobile instrument carts, FlexCore can provide a unique working environment tailored to individual needs. With durable, rugged construction designed specifically for today's industrial, research and university laboratories - and, at an affordable price point - FlexCore is an exciting alternative. Perhaps more importantly, FlexCore is designed to easily connect to almost all competitor units, at a more affordable price.

FlexCore instrument carts can be assembled from a wide array of components to create mobile benches, bookcases, computer support or docking desk environments. Services can be easily managed through simple access panels, while not interrupting operations.

FlexCore is a spine and core based system, utilizing the benefits of true service management while allowing virtually unlimited choices for personal layouts. The ICI solution is really a flex-light approach, making the ability to reconfigure the laboratory affordable.

Features include:

- 14 gauge dual channel uprights
- Integral cable chase-ways
- Sized from 24"- 72" in 6" increments
- Easily removed covers
- Inner and outer shelving
- Depths in 3.25", 6", 8.75" and 12"
- Built-in pipe supports
- Static service panel allows desk height accessibility for both electrical and data
- Knock-down design reduces costly freight & eases job site handling
- Made in the USA

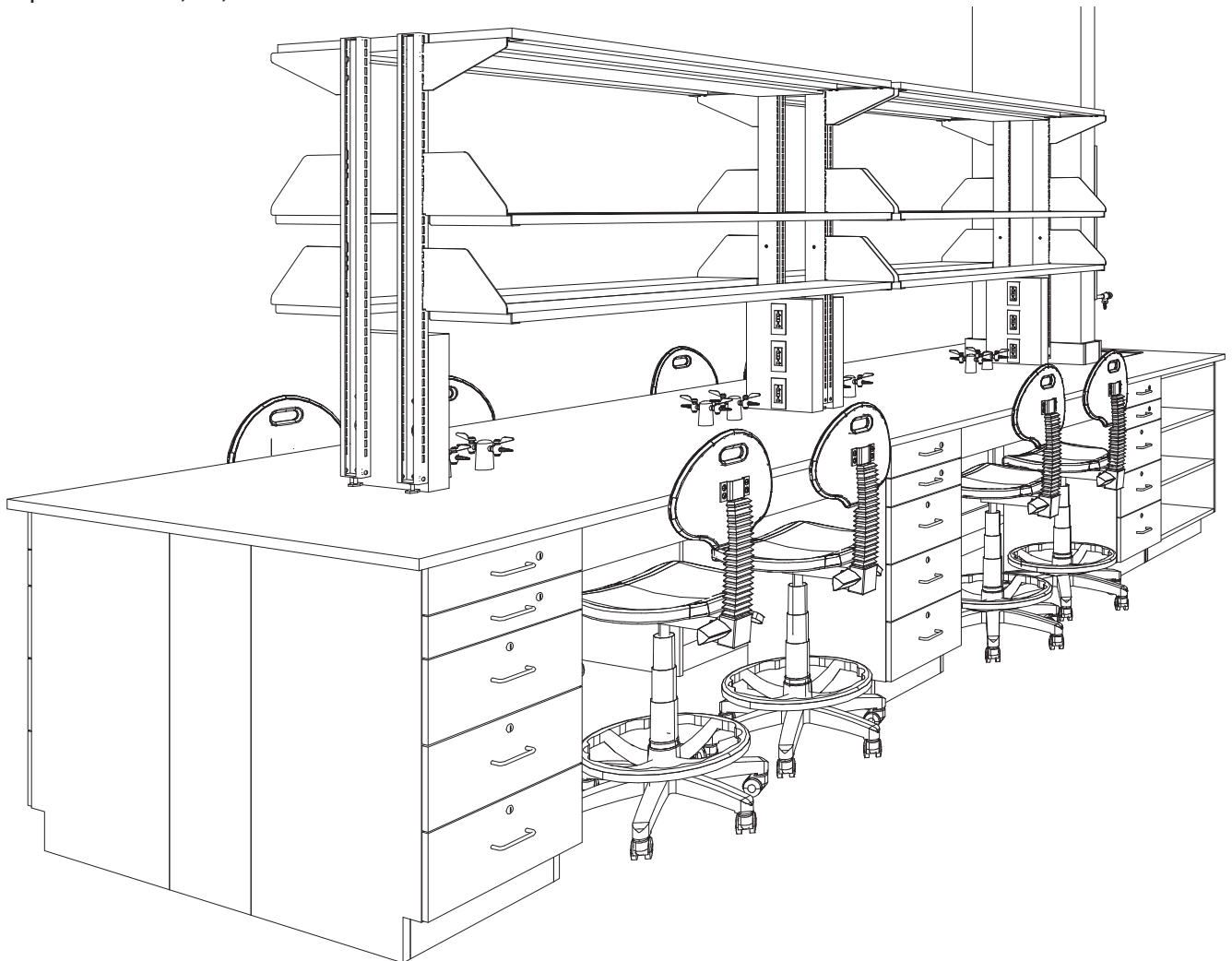

FlexCore Frame Assembly

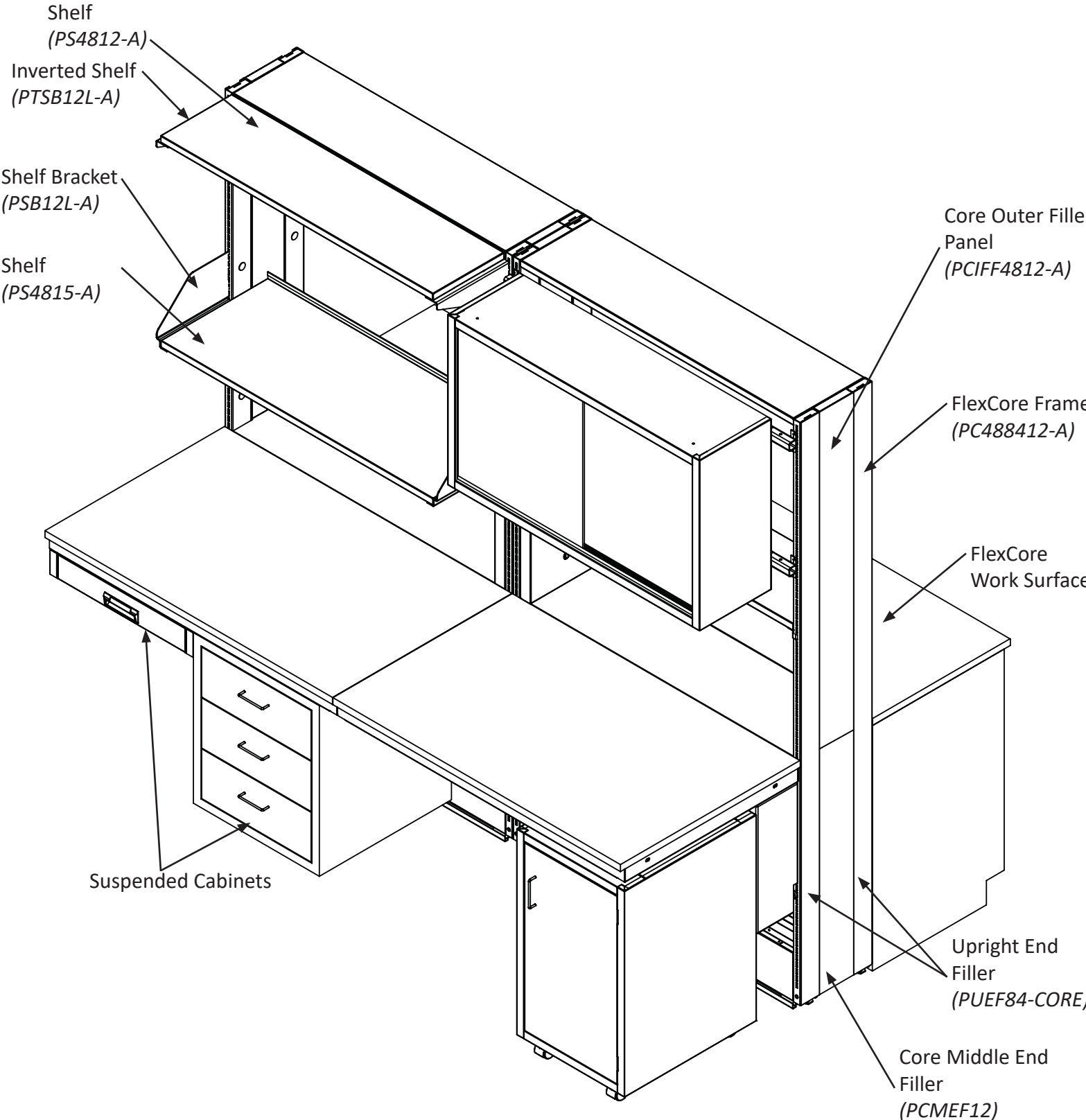

FlexCore Frame

36" Tall FlexCore Frame - 3.25" Deep

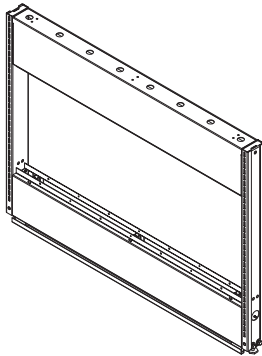

- 36" tall x 3.25" deep frame
- Replace "P" with a "S" for Stainless Steel

Cat. No.	Width
PC2436325-A	24"
PC3036325-A	30"
PC3636325-A	36"
PC4236325-A	42"
PC4836325-A	48"
PC5436325-A	54"
PC6036325-A	60"
PC6636325-A	66"
PC7236325-A	72"

36" Tall FlexCore Frame - 6" Deep

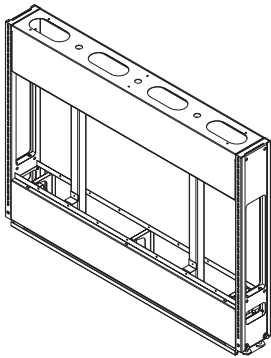

- 36" tall x 6" deep frame
- Replace "P" with a "S" for Stainless Steel

Cat. No.	Width
PC243606-A	24"
PC303606-A	30"
PC363606-A	36"
PC423606-A	42"
PC483606-A	48"
PC543606-A	54"
PC603606-A	60"
PC663606-A	66"
PC723606-A	72"

36" Tall FlexCore Frame - 12" Deep

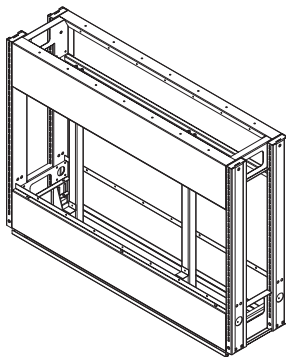

- 36" tall x 12" deep frame
- Replace "P" with a "S" for Stainless Steel

Cat. No.	Width
PC243612-A	24"
PC303612-A	30"
PC363612-A	36"
PC423612-A	42"
PC483612-A	48"
PC543612-A	54"
PC603612-A	60"
PC663612-A	66"
PC723612-A	72"

48" Tall FlexCore Frame - 3.25" Deep

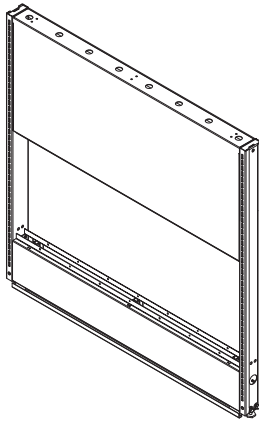

- 48" tall x 3.25" deep frame
- Replace "P" with a "S" for Stainless Steel

Cat. No.	Width
PC2448325-A	24"
PC3048325-A	30"
PC3648325-A	36"
PC4248325-A	42"
PC4848325-A	48"
PC5448325-A	54"
PC6048325-A	60"
PC6648325-A	66"
PC7248325-A	72"

48" Tall FlexCore Frame - 6" Deep

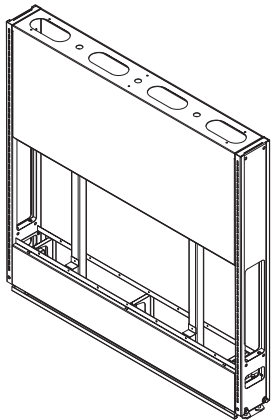

- 48" tall x 6" deep frame
- Replace "P" with a "S" for Stainless Steel

Cat. No.	Width
PC244806-A	24"
PC304806-A	30"
PC364806-A	36"
PC424806-A	42"
PC484806-A	48"
PC544806-A	54"
PC604806-A	60"
PC664806-A	66"
PC724806-A	72"

48" Tall FlexCore Frame - 12" Deep

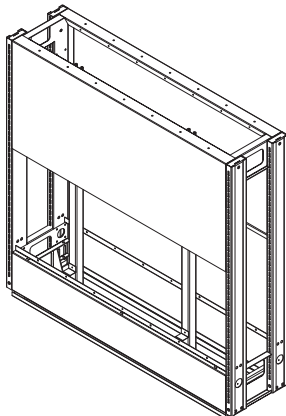

- 48" tall x 12" deep frame
- Replace "P" with a "S" for Stainless Steel

Cat. No.	Width
PC244812-A	24"
PC304812-A	30"
PC364812-A	36"
PC424812-A	42"
PC484812-A	48"
PC544812-A	54"
PC604812-A	60"
PC664812-A	66"
PC724812-A	72"

FlexCore Frame

84" Tall FlexCore Frame - 3.25" Deep - 36" Tall Ledge Support

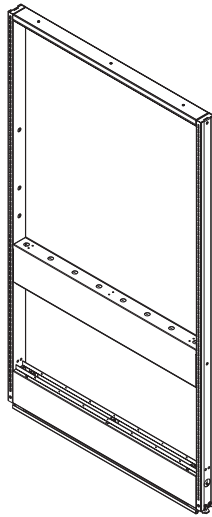

- 84" tall x 3.25" deep frame
- Ledge support set at 36" high
- Replace "P" with a "S" for Stainless Steel

Cat. No.	Width
PC2484325-A	24"
PC3084325-A	30"
PC3684325-A	36"
PC4284325-A	42"
PC4884325-A	48"
PC5484325-A	54"
PC6084325-A	60"
PC6684325-A	66"
PC7284325-A	72"

84" Tall FlexCore Frame - 6" Deep - 36" Tall Ledge Support

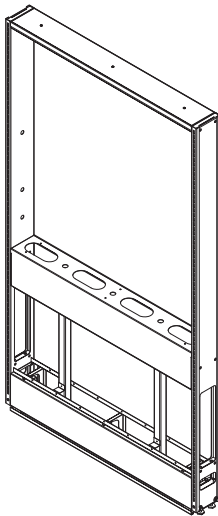

- 84" tall x 6" deep frame
- Ledge support set at 36" high
- Replace "P" with a "S" for Stainless Steel
- Maximum load rating of 2,820 lbs., evenly balanced on both sides

Cat. No.	Width
PC248406-A	24"
PC308406-A	30"
PC368406-A	36"
PC428406-A	42"
PC488406-A	48"
PC548406-A	54"
PC608406-A	60"
PC668406-A	66"
PC728406-A	72"

84" Tall FlexCore Frame - 12" Deep - 36" Tall Ledge Support

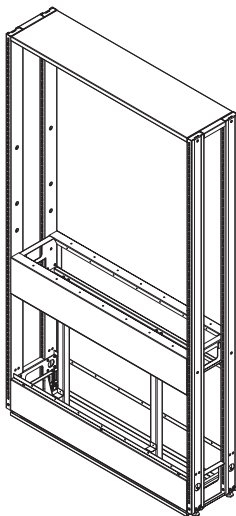

- 84" tall x 12" deep frame
- Ledge support set at 36" high
- Replace "P" with a "S" for Stainless Steel
- Maximum load rating of 2,820 lbs., evenly balanced on both sides

Cat. No.	Width
PC248412-A	24"
PC308412-A	30"
PC368412-A	36"
PC428412-A	42"
PC488412-A	48"
PC548412-A	54"
PC608412-A	60"
PC668412-A	66"
PC728412-A	72"

84" Tall FlexCore Frame - 3.25" Deep - 48" Tall Ledge Support

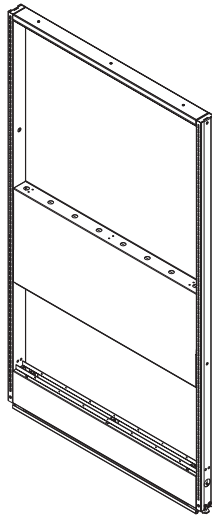

- 84" tall x 3.25" deep frame
- Ledge support set at 48" high
- Replace "P" with a "S" for Stainless Steel

Cat. No.	Width
PC248448325-A	24"
PC308448325-A	30"
PC368448325-A	36"
PC428448325-A	42"
PC488448325-A	48"
PC548448325-A	54"
PC608448325-A	60"
PC668448325-A	66"
PC728448325-A	72"

84" Tall FlexCore Frame - 6" Deep - 48" Tall Ledge Support

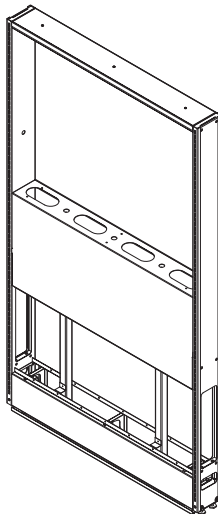

- 84" tall x 6" deep frame
- Ledge support set at 48" high
- Replace "P" with a "S" for Stainless Steel
- Maximum load rating of 2,820 lbs., evenly balanced on both sides

Cat. No.	Width
PC24844806-A	24"
PC30844806-A	30"
PC36844806-A	36"
PC42844806-A	42"
PC48844806-A	48"
PC54844806-A	54"
PC60844806-A	60"
PC66844806-A	66"
PC72844806-A	72"

84" Tall FlexCore Frame - 12" Deep - 48" Tall Ledge Support

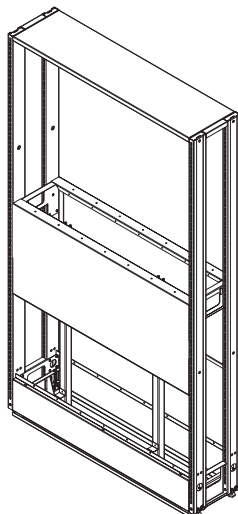

- 84" tall x 12" deep frame
- Ledge support set at 48" high
- Replace "P" with a "S" for Stainless Steel
- Maximum load rating of 2,820 lbs., evenly balanced on both sides

Cat. No.	Width
PC24844812-A	24"
PC30844812-A	30"
PC36844812-A	36"
PC42844812-A	42"
PC48844812-A	48"
PC54844812-A	54"
PC60844812-A	60"
PC66844812-A	66"
PC72844812-A	72"

FlexCore Frame

36" Tall Wall FlexCore Frame - 8.75" Deep

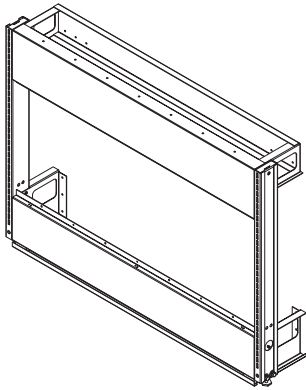

- 36" tall x 8.75" deep wall frame
- Replace "P" with a "S" for Stainless Steel

Cat. No.	Width
PWC2436875-A	24"
PWC3036875-A	30"
PWC3636875-A	36"
PWC4236875-A	42"
PWC4836875-A	48"
PWC5436875-A	54"
PWC6036875-A	60"
PWC6636875-A	66"
PWC7236875-A	72"

48" Tall Wall FlexCore Frame - 8.75" Deep

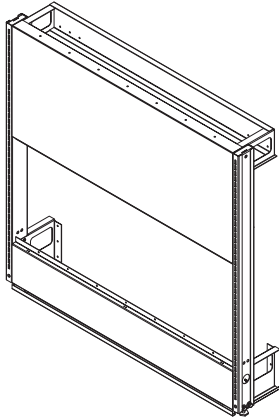

- 48" tall x 8.75" deep wall frame
- Replace "P" with a "S" for Stainless Steel

Cat. No.	Width
PWC2448875-A	24"
PWC3048875-A	30"
PWC3648875-A	36"
PWC4248875-A	42"
PWC4848875-A	48"
PWC5448875-A	54"
PWC6048875-A	60"
PWC6648875-A	66"
PWC7248875-A	72"

84" Tall Wall FlexCore Frame - 8.75" Deep - 36" Tall Ledge Support

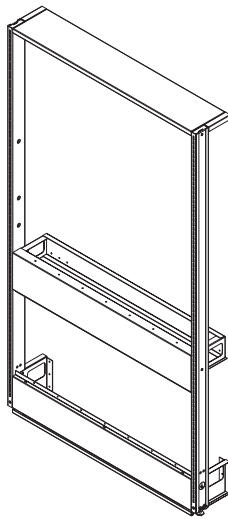

- 84" tall x 8.75" deep wall frame
- Replace "P" with and "S" for Stainless Steel
- Maximum load rating of 1,680 lbs.

Cat. No.	Width
PWC2484875-A	24"
PWC3084875-A	30"
PWC3684875-A	36"
PWC4284875-A	42"
PWC4884875-A	48"
PWC5484875-A	54"
PWC6084875-A	60"
PWC6684875-A	66"
PWC7284875-A	72"

84" Tall Wall FlexCore Frame - 8.75" Deep - 48" Tall Ledge Support

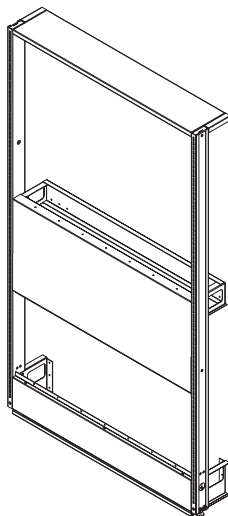

- 84" tall x 8.75" deep wall frame
- Replace "P" with and "S" for Stainless Steel
- Maximum load rating of 1,680 lbs.

Cat. No.	Width
PWC248448875-A	24"
PWC308448875-A	30"
PWC368448875-A	36"
PWC428448875-A	42"
PWC488448875-A	48"
PWC548448875-A	54"
PWC608448875-A	60"
PWC668448875-A	66"
PWC728448875-A	72"

FlexCore Frame

48" Tall Bench Top FlexCore Frame - 6" Deep

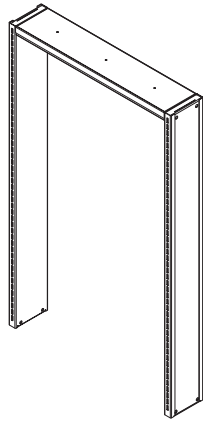

- 48" tall x 6" deep bench top frame
- Replace "P" with a "S" for Stainless Steel
- Maximum load rating of 900 lbs., evenly balanced on both sides

Cat. No.	Width
PCB244806-A	24"
PCB304806-A	30"
PCB364806-A	36"
PCB424806-A	42"
PCB484806-A	48"
PCB544806-A	54"
PCB604806-A	60"
PCB664806-A	66"
PCB724806-A	72"

48" Tall Bench Top FlexCore Frame - 12" Deep

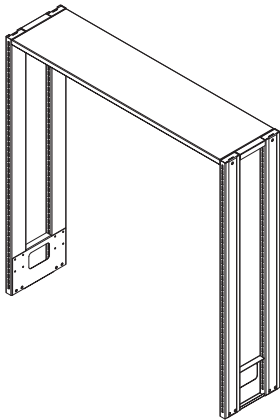

- 48" tall x 12" deep bench top frame
- Replace "P" with a "S" for Stainless Steel
- Maximum load rating of 1,080 lbs., evenly balanced on both sides

Cat. No.	Width
PCB244812-A	24"
PCB304812-A	30"
PCB364812-A	36"
PCB424812-A	42"
PCB484812-A	48"
PCB544812-A	54"
PCB604812-A	60"
PCB664812-A	66"
PCB724812-A	72"

48" Tall Bench Top Wall FlexCore Frame - 8.75" Deep

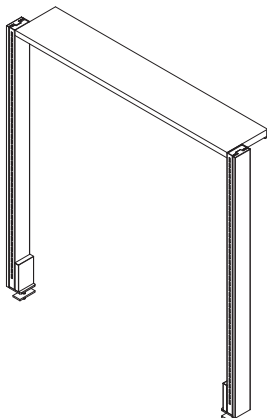

- 48" tall x 8.75" deep bench top frame
- Replace "P" with a "S" for Stainless Steel

Cat. No.	Width
PCB2448875-A	24"
PCB3048875-A	30"
PCB3648875-A	36"
PCB4248875-A	42"
PCB4848875-A	48"
PCB5448875-A	54"
PCB6048875-A	60"
PCB6648875-A	66"
PCB7248875-A	72"

Cabinet to Core Connector with Filler

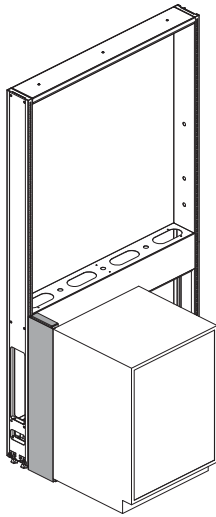

- Connects a base cabinet to the FlexCore Core Frame
- Replace "P" with a "S" for Stainless Steel

Cat. No.	Counter Top Depth	Side
PCCC24L	24"	Left
PCCC24R	24"	Right
PCCC30L	30"	Left
PCCC30R	30"	Right

Cabinet to Core Connector

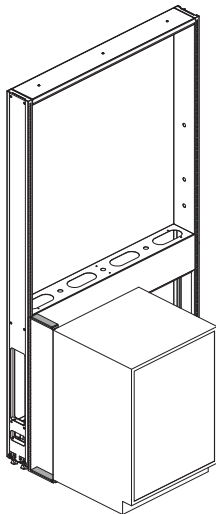

- Connects a base cabinet to the FlexCore Core Frame
- Replace "P" with a "S" for Stainless Steel

Cat. No.	Counter Top Depth	Side
PCCC24NFL	24"	Left
PCCC24NFR	24"	Right
PCCC30NFL	30"	Left
PCCC30NFR	30"	Right

Core Connector Hardware

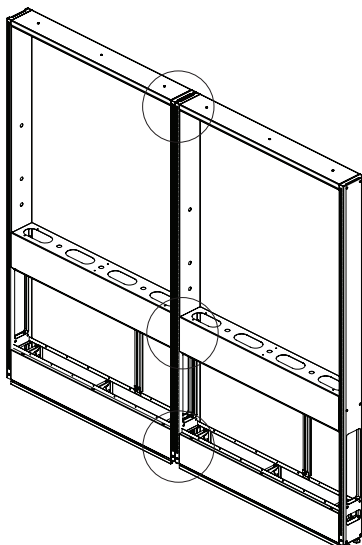

- Kit Includes (3 points of connection):
 - (4) Nuts, 3/8-16
 - (4) Washers, Lock 3/8"
 - (2) HHCS, 3/8-16 x 3 1/2", grade 5
 - (2) HHCS, 3/8-18 x 4", grade 5

Cat. No.	Depth
PLCH0325-Kit B	3.25" or 8.75" Wall Core
PLCH06-Kit B	6"
PLCH012-Kit B	12"

FlexCore Connectors

Outrigger Leg Assemblies

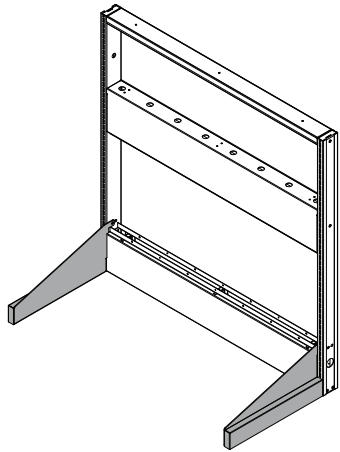

Cat. No.	Depth
PLA20L	20"
PLA20R	20"

"L" Connector - 36" Tall - 1/2 Height

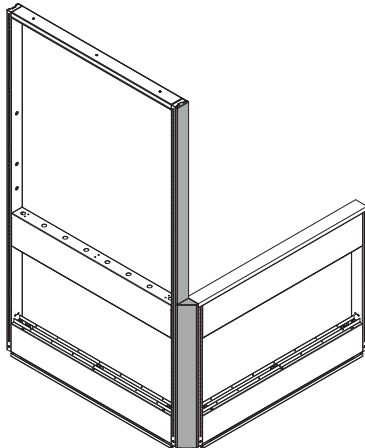

- "L" connector for (1) 84" tall core and (1) 36" tall core
- Replace "P" with a "S" for Stainless Steel

Cat. No.	Core Depth
PFHSHLC0325	3.25"
PFHSHLC06	6"

"L" Connector - 48" Tall - 1/2 Height

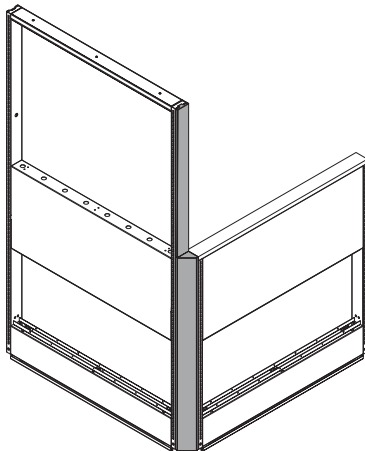

- "L" connector for (1) 84" tall core and (1) 48" tall core
- Replace "P" with a "S" for Stainless Steel

Cat. No.	Core Depth
PFHSHLC480325	3.25"
PFHSHLC4806	6"

"L" Connector - 36" Tall - Full Height

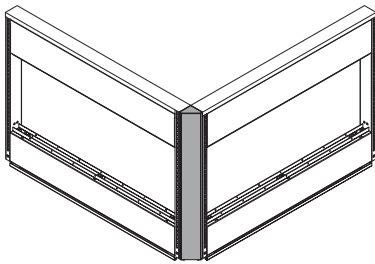

- "L" connector for (2) 36" tall core
- Replace "P" with a "S" for Stainless Steel

Cat. No.	Core Depth
PSHSHLC0325	3.25"
PSHSHLC06	6"

"L" Connector - 48" Tall - Full Height

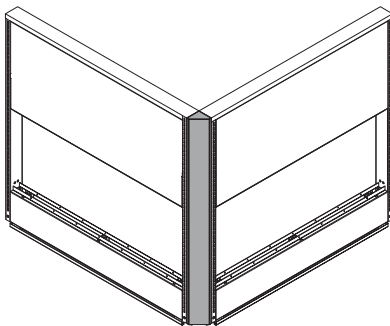

- "L" connector for (2) 48" tall core
- Replace "P" with a "S" for Stainless Steel

Cat. No.	Core Depth
PSHSHLC480325	3.25"
PSHSHLC4806	6"

"L" Connector - 84" Tall - Full Height

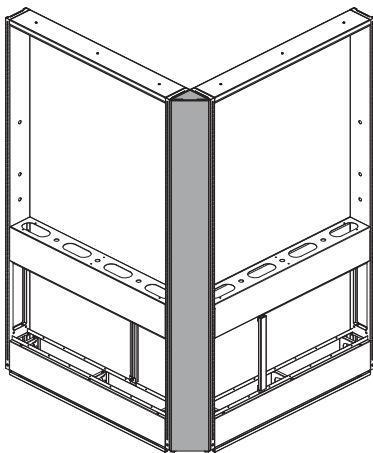

- "L" connector for (2) 84" tall cores
- Replace "P" with a "S" for Stainless Steel

Cat. No.	Core Depth
PFHFHLC0325	3.25"
PFHFHLC06	6"

FlexCore Connectors

"T" or "X" Connector - 36" Tall - Full Height

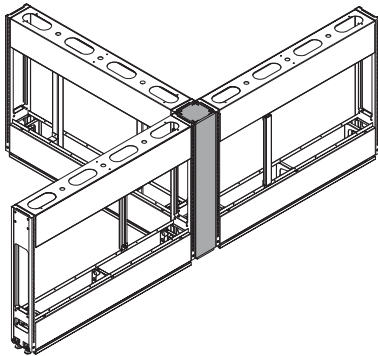

- "T" x "X" connector for (2) 36" tall core
- Replace "P" with a "S" for Stainless Steel

Cat. No.	Core Depth
PSHSHTC0325	3.25"
PSHSHTC06	6"

"T" or "X" Connector - 48" Tall - Full Height

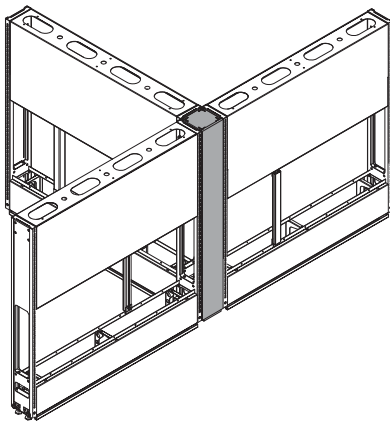

- "T" x "X" connector for (2) 48" tall core
- Replace "P" with a "S" for Stainless Steel

Cat. No.	Core Depth
PSHSHTC480325	3.25"
PSHSHTC4806	6"

"T" or "X" Connector

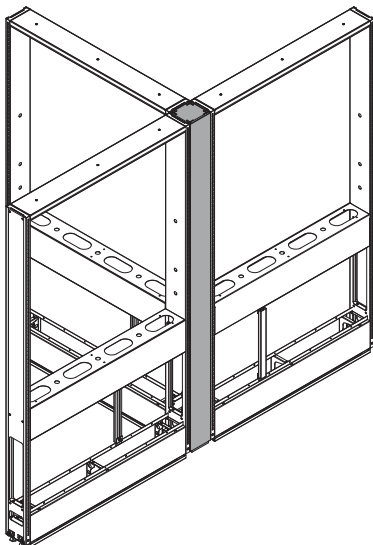

- "T" or "X" connector for (2) 84" tall cores
- Replace "P" with a "S" for Stainless Steel

Cat. No.	Core Depth
PFHFHTC0325	3.25"
PFHFHTC06	6"

Corner Column Detail

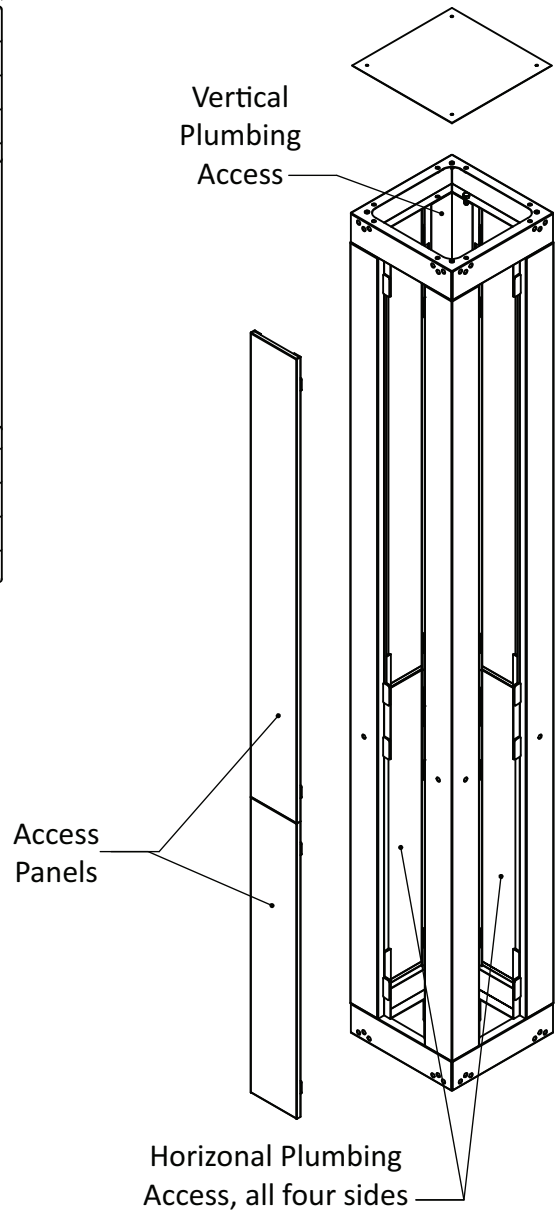
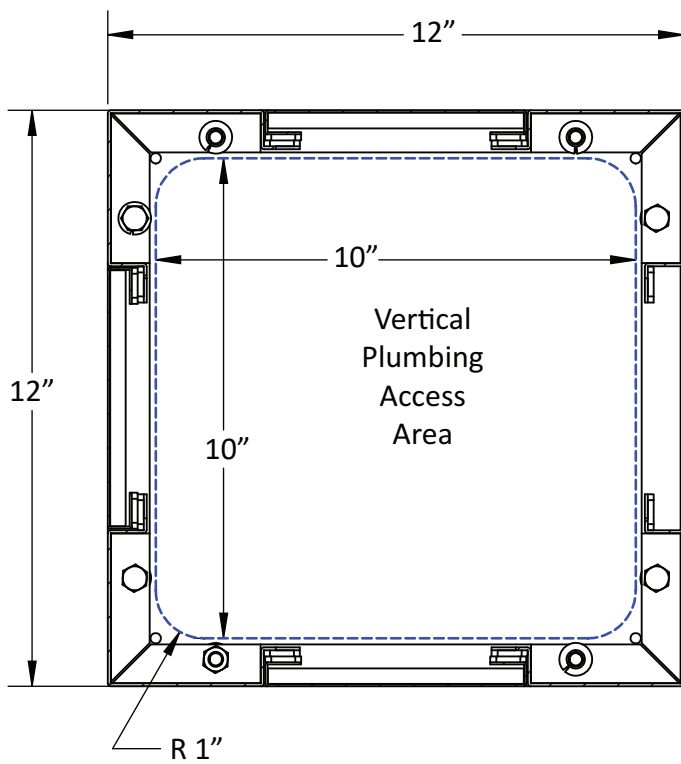

FlexCore Connectors

Corner Column - 36" Tall

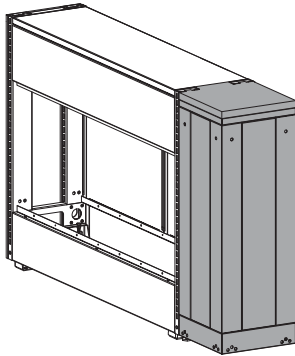

- Corner Column is to be used with 12" Core
- Can be use for "T" or "X" configuration
- Replace "P" with and "S" for Stainless Steel

Cat. No.	Core Depth
PSHCC12	12"

Corner Column - 48" Tall

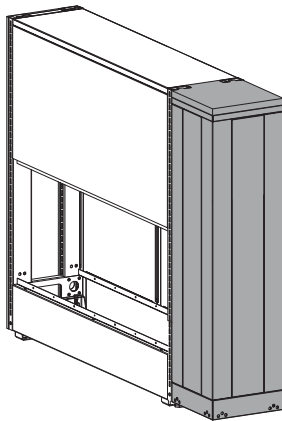

- Corner Column is to be used with 12" Core
- Can be use for "T" or "X" configuration
- Replace "P" with and "S" for Stainless Steel

Cat. No.	Core Depth
PSHCC4812	12"

Corner Column - 84" Tall

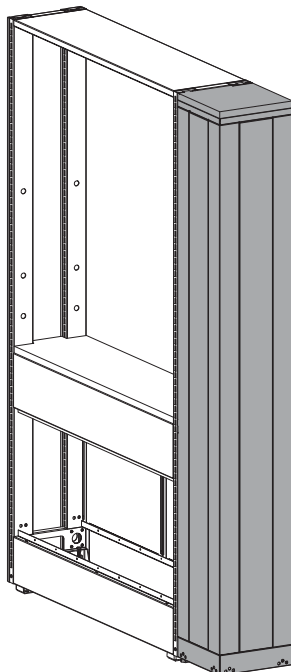

- Corner Column is to be used with 12" Core
- Can be use for "T" or "X" configuration
- Replace "P" with and "S" for Stainless Steel

Cat. No.	Core Depth
PFHCC12	12"

Service Column Detail

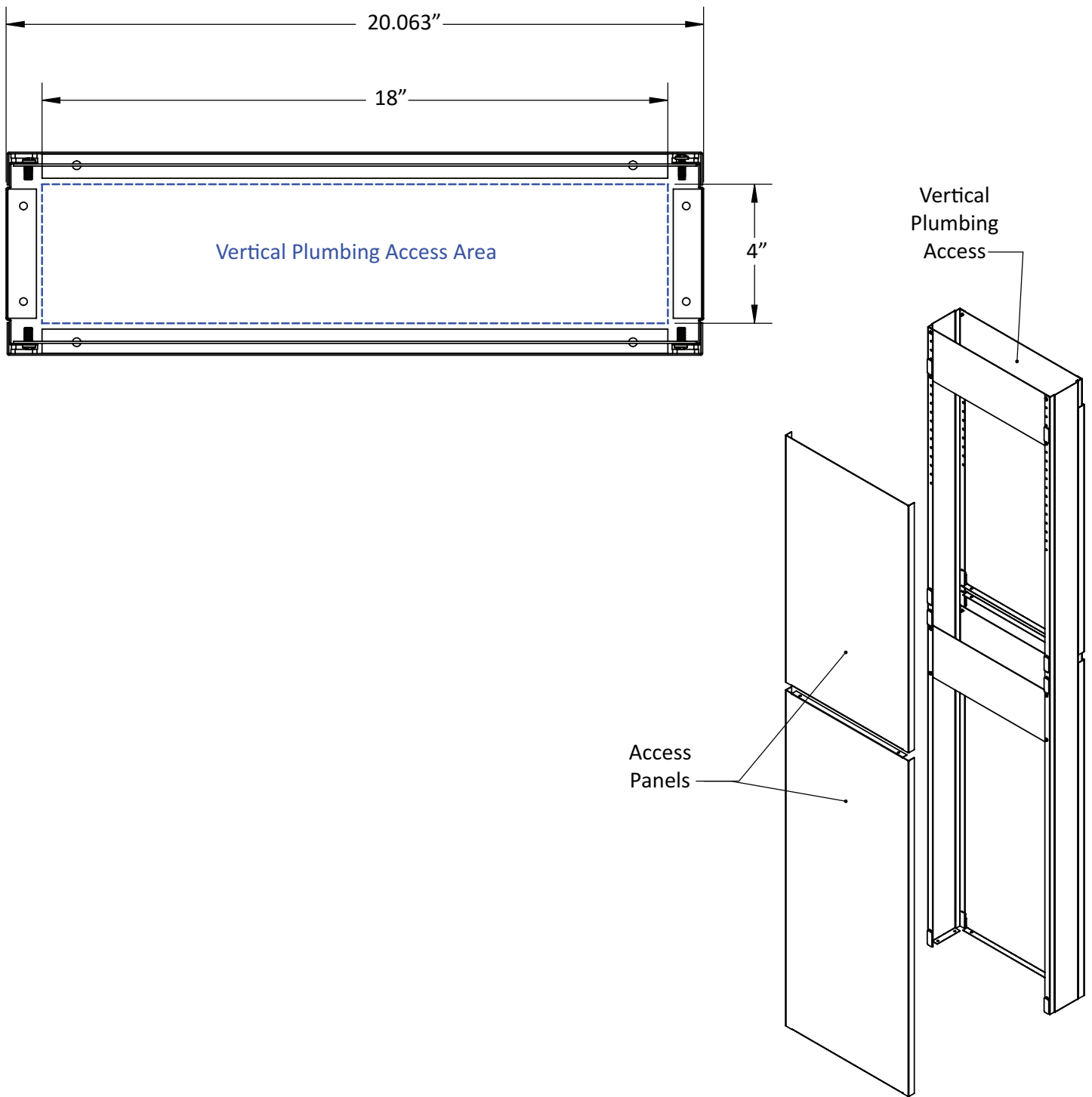

FlexCore Connectors

Corner Column Ceiling Extension

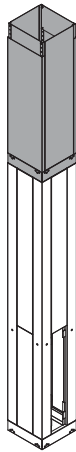

- Corner Column Ceiling Extension to be used with a 12" x 12" Corner Column
- Replace "P" with and "S" for Stainless Steel

Cat. No.	Dimensions
PCE12	12" x 12"

Service Column for 12" Core

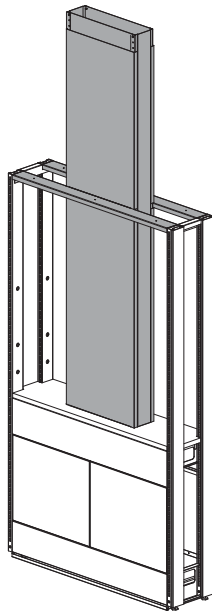

- Replace "P" with and "S" for Stainless Steel
- Includes pipe chase and top rail

Cat. No.	Width
PSC24	24"
PSC30	30"
PSC36	36"
PSC42	42"
PSC48	48"
PSC54	54"
PSC60	60"
PSC66	66"
PSC72	72"

Core Inner Filler Panel - Elec/Plumb

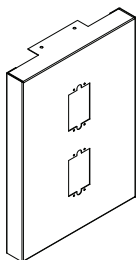

PCIF12-E

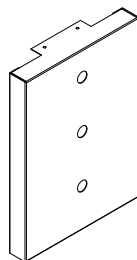

PCIF12-P

- Elec/Plumb Core Inner Filler Panel is 16.5" tall
- Replace "P" with a "S" for Stainless Steel

Cat. No.	Type	Depth
PCIF06-E	Electrical	6"
PCIF12-E	Electrical	12"
PCIF06-P	Plumbing	6"
PCIF12-P	Plumbing	12"

Core Outer Filler Panel

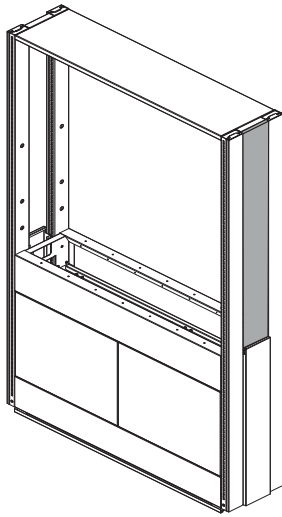

- Replace "P" with a "S" for Stainless Steel

Cat. No.	Height	Depth of Core
PCIFF4812-A	48.5"	12"
PCIFF3612-A	36.5"	12"

Core Middle End Filler - with Elec/Plumb

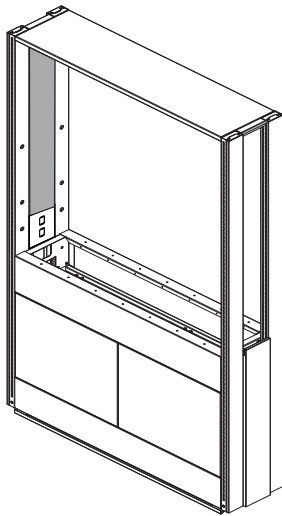

- Replace "P" with a "S" for Stainless Steel

Cat. No.	Height	Depth of Core
PCIFF3206-A	32"	12"
PCIFF2006-A	20"	12"

Core Middle End Filler

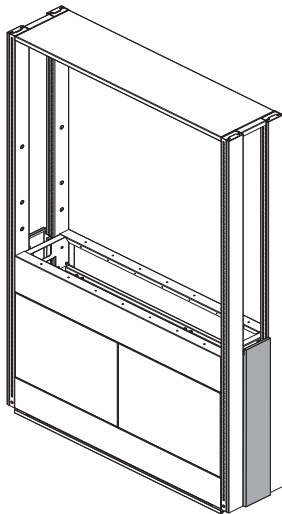

- Replace "P" with and "S" for Stainless Steel

Cat. No.	Height of Core	Depth of Core
PCMEF12	84"	12"
PCMEF3612	36"	12"
PCMEF4812	48"	12"

FlexCore Fillers

Upright End Filler

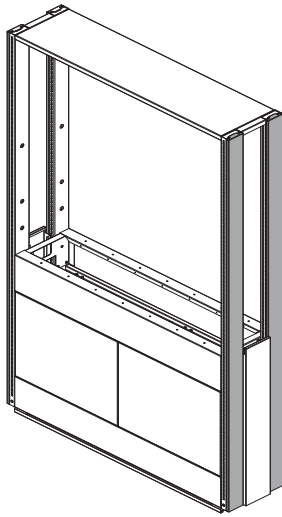

(2) Upper End Fillers shown on a 12" deep core

- Replace "P" with and "S" for Stainless Steel
- Fillers sold individually
- 3.25" and 6" deep cores require (1) filler per side
- 12" deep cores require (2) 3.25" deep fillers per side

Cat. No.	Height	Depth
PUEF36-Core	36"	3.25"
PUEF3606-Core	36"	6"
PUEF48-Core	48"	3.25"
PUEF4806-Core	48"	6"
PUEF84-Core	84"	3.25"
PUEF8406-Core	84"	6"

Bench Top Core Filler

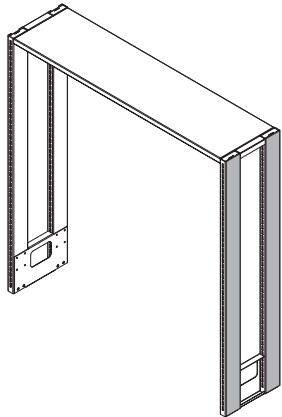

(2) Bench Top Core Fillers shown on a 12" deep core

- Replace "P" with and "S" for Stainless Steel
- Fillers sold individually
- 6" and 8.75" deep cores require (1) filler per side
- 12" deep cores require (2) 3.25" deep fillers per side

Cat. No.	Height	Depth
PBEF48-CORE	48"	3.25"
PBEF4806-CORE	48"	6"

Bench Top Core Filler

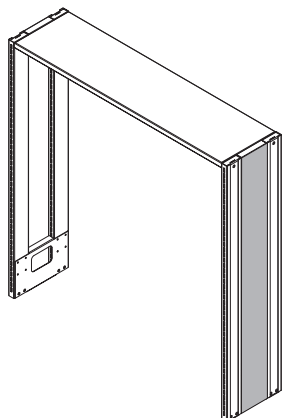

(1) Bench Top Core Fillers shown on a 12" deep core

- Replace "P" with and "S" for Stainless Steel
- Fillers sold individually

Cat. No.	Height	For use with:
PCIFF4812-A	48"	12" deep Bench Top Core

Lower Core Half Panels

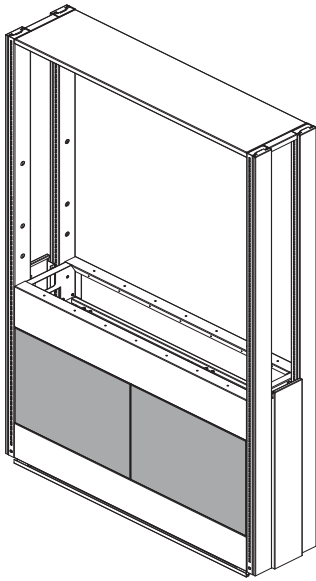

Shown on a 12" Frame

- Each part number includes (1) half flush panel for the lower part of a FlexCore Core
- Height of Lower Core Half Panels is 19"
- Can be used with 36" or 48" ledge. Can be used with any depth core
- Free-standing cores are double sided are require (4) panels to enclose the entire lower part of the Core
- Replace "P" with and "S" for Stainless Steel

Cat. No.	Width of Frame	Actual Panel Width
PCFP2419	24"	12"
PCFP3019	30"	15"
PCFP3619	36"	18"
PCFP4219	42"	21"
PCFP4819	48"	24"
PCFP5419	54"	27"
PCFP6019	60"	30"
PCFP6619	66"	33"
PCFP7219	72"	36"

Upper Core Half Panels

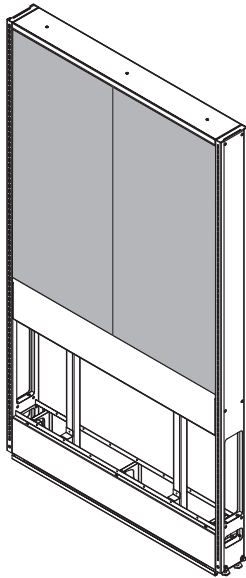

Shown on a 6" Frame

- Each part number includes (1) half flush panel for the upper part of a FlexCore Core
- Upper Core Half Panels can only be used with 84" tall cores
- Upper Core Half Panels can only be used with 3.25" and 6" deep cores
- Free-standing cores are double sided are require (4) panels to enclose the entire upper part of the Core
- Replace "P" with and "S" for Stainless Steel

Cat. No.	Width of Frame	Actual Panel Width	For use with:
36" Tall Panel			
PCFP2436	24"	12"	48" Tall Ledge
PCFP3036	30"	15"	48" Tall Ledge
PCFP3636	36"	18"	48" Tall Ledge
PCFP4236	42"	21"	48" Tall Ledge
PCFP4836	48"	24"	48" Tall Ledge
PCFP5436	54"	27"	48" Tall Ledge
PCFP6036	60"	30"	48" Tall Ledge
PCFP6636	66"	33"	48" Tall Ledge
PCFP7236	72"	36"	48" Tall Ledge
48" Tall Panel			
PCFP2448	24"	12"	36" Tall Ledge
PCFP3048	30"	15"	36" Tall Ledge
PCFP3648	36"	18"	36" Tall Ledge
PCFP4248	42"	21"	36" Tall Ledge
PCFP4848	48"	24"	36" Tall Ledge
PCFP5448	54"	27"	36" Tall Ledge
PCFP6048	60"	30"	36" Tall Ledge
PCFP6648	66"	33"	36" Tall Ledge
PCFP7248	72"	36"	36" Tall Ledge

FlexCore Cantilever Frame

Cantilever Frames

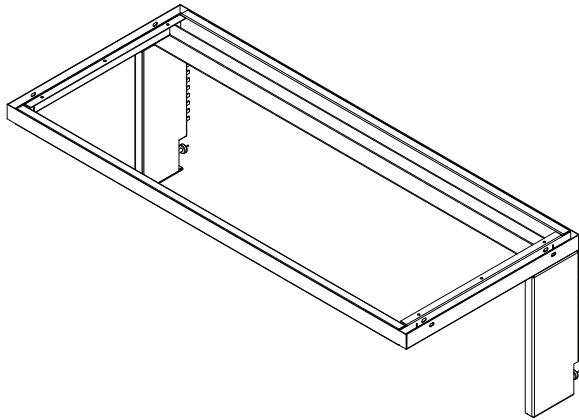

- To be used with any FlexCore Core or Cart
- Replace "P" with and "S" for Stainless Steel
- Weight Capacity up to 600 lbs UDL (includes weight of work surface or suspended cabinets)

Cat. No.	23" Deep Frame	Width
PCF2423		24"
PCF3023		30"
PCF3623		36"
PCF4223		42"
PCF4823		48"
PCF5423		54"
PCF6023		60"
PCF6623		66"
PCF7223		72"

Cat. No.	26" Deep Frame	Width
PCF2426		24"
PCF3026		30"
PCF3626		36"
PCF4226		42"
PCF4826		48"
PCF5426		54"
PCF6026		60"
PCF6626		66"
PCF7226		72"

Cat. No.	27" Deep Frame	Width
PCF2427		24"
PCF3027		30"
PCF3627		36"
PCF4227		42"
PCF4827		48"
PCF5427		54"
PCF6027		60"
PCF6627		66"
PCF7227		72"

Cat. No.	29" Deep Frame	Width
PCF2429		24"
PCF3029		30"
PCF3629		36"
PCF4229		42"
PCF4829		48"
PCF5429		54"
PCF6029		60"
PCF6629		66"
PCF7229		72"

Corner Cantilever Frames

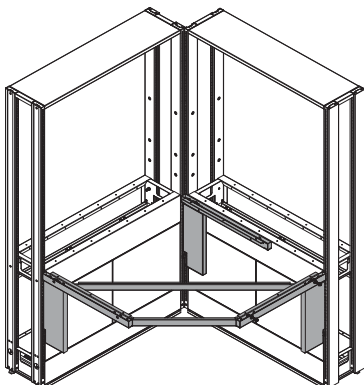

- To be used with any FlexCore Core in a corner situation
- Replace "P" with and "S" for Stainless Steel

Cat. No.	29" Deep Frame	Width
PCF3629-90		36"
PCF4829-90		48"

FlexCore Work Surfaces

FlexCore Work Surfaces are custom to each FlexCore Assembly or FlexCore Cart. Please contact your ICI Representative to consult about work surfaces.

Examples of Cantilever FlexCore Mobile Cart Work Surface:

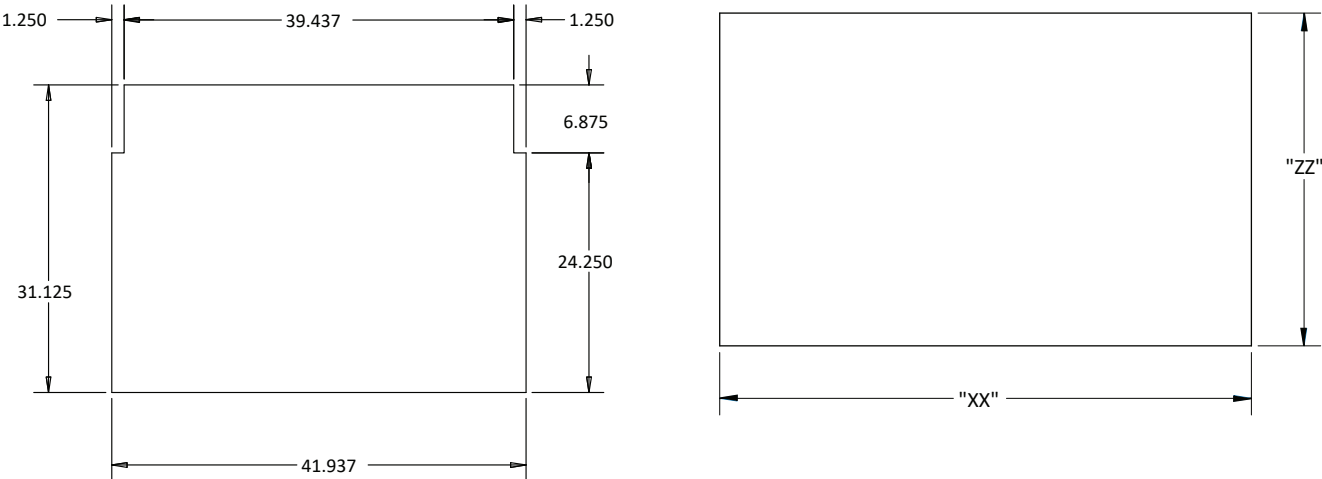

Example of 12" Core Work Surface:

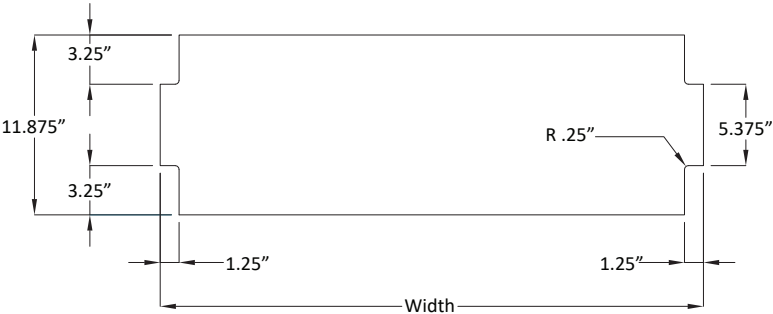

Example of 8.75" Wall Core Work Surface:

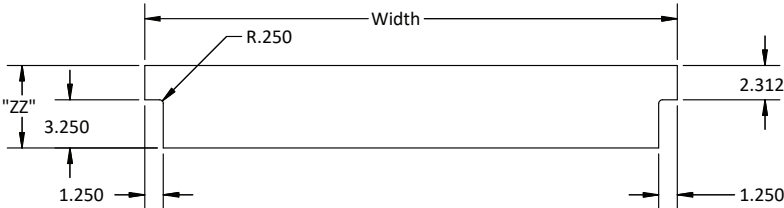

FlexCore Shelving

Shelf Bracket

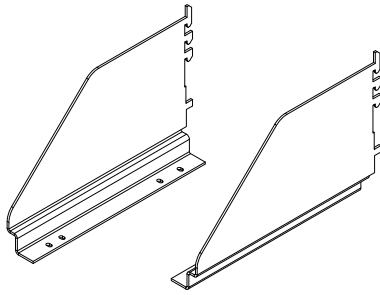

- To be used with and FlexCore Core or Cart
- Replace "P" with and "S" for Stainless Steel

Cat. No.	Type	Depth
PSB06R-A	Right Hand	6"
PSB06L-A	Left Hand	6"
PSB09R-A	Right Hand	9"
PSB09L-A	Left Hand	9"
PSB12R-A	Right Hand	12"
PSB12L-A	Left Hand	12"
PSB15R-A	Right Hand	15"
PSB15L-A	Left Hand	15"
PSB18R-A	Right Hand	18"
PSB18L-A	Left Hand	18"
PSB24R-A	Right Hand	24"
PSB24L-A	Left Hand	24"

Inverted Shelf Bracket

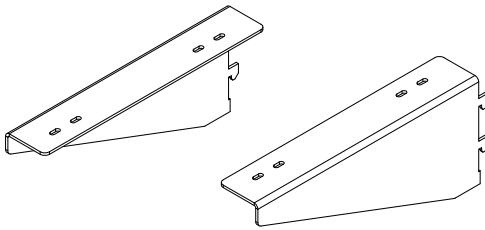

- To be used with and FlexCore Core or Cart
- Replace "P" with and "S" for Stainless Steel

Cat. No.	Type	Depth
PTSB06R-A	Right Hand	6"
PTSB06L-A	Left Hand	6"
PTSB09R-A	Right Hand	9"
PTSB09L-A	Left Hand	9"
PTSB12R-A	Right Hand	12"
PTSB12L-A	Left Hand	12"
PTSB15R-A	Right Hand	15"
PTSB15L-A	Left Hand	15"
PTSB18R-A	Right Hand	18"
PTSB18L-A	Left Hand	18"
PTSB24R-A	Right Hand	24"
PTSB24L-A	Left Hand	24"

Inverted Shelf Bracket for Wall Cores

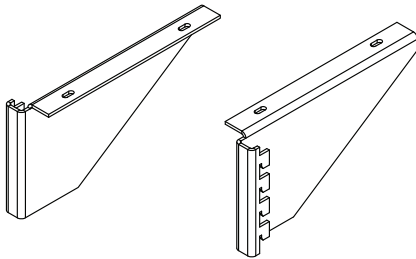

- To be used with and FlexCore Core, Cart or Wall Upright
- Replace "P" with and "S" for Stainless Steel

Cat. No.	Type	Depth
PWSB875R-A	Right Hand	8.75"
PWSB875L-A	Left Hand	8.75"

Inner Shelf Clips

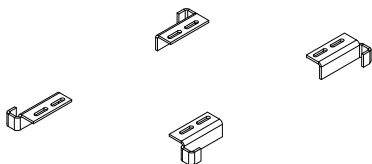

- Quantity of (4): (2) Left and (2) Right
- Replace "P" with and "S" for Stainless Steel

Cat. No.	Type
PISB-A	Inner Shelf Clips

Wall Cabinet Hanger

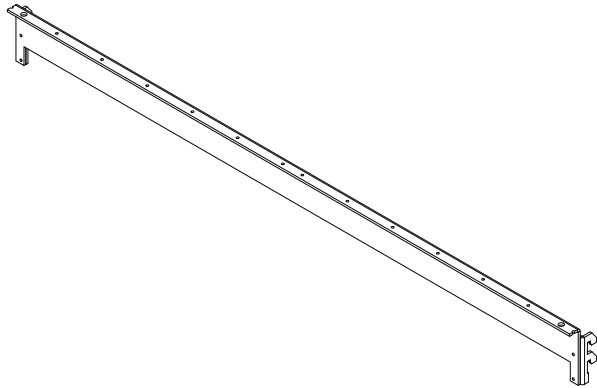

- To be used with and FlexCore Core or Cart
- Includes (2) hangers for mounting wall cabinets
- See Wall Cabinet section of CornerStone Catalog for wall cabinet options
- Replace "P" with and "S" for Stainless Steel

Cat. No.	Width
PWCH24	24"
PWCH30	30"
PWCH36	36"
PWCH42	42"
PWCH48	48"
PWCH54	54"
PWCH60	60"
PWCH66	66"
PWCH72	72"

Inner Wall Core Shelves

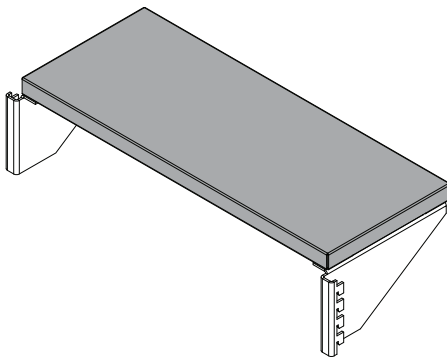

Shelf: PWS24875-A
Brackets: PWSB875L-A & PWSB875R-A

- To be used with Inverted Shelf Bracket for 8.75" Deep Wall Core only
- Part Number only includes shelf. Brackets sold separately.
- Inner Wall Core Shelf is 8.75" deep
- Replace "P" with and "S" for Stainless Steel

Cat. No.	Width
PWS24875-A	24"
PWS30875-A	30"
PWS36875-A	36"
PWS42875-A	42"
PWS48875-A	48"
PWS54875-A	54"
PWS60875-A	60"
PWS66875-A	66"
PWS72875-A	72"

FlexCore Shelving

Inner/Outer Shelves

Shelf Examples

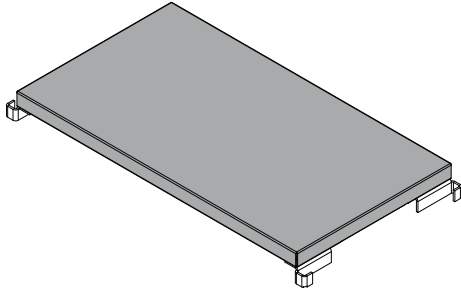

Shelf: PS2412-A
Shelf Clips: PISB-A

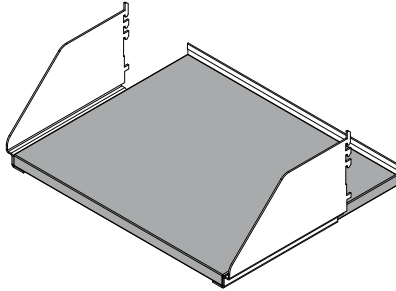

Shelf: PS3015-A
Brackets: PSB12L-A & PSB12R-A
Shelf Lip: PSL30

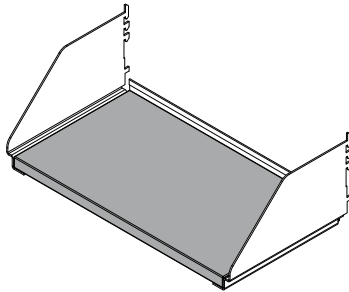

Shelf: PS3018-A
Brackets: PSB18L-A & PSB18R-A
Shelf Lip: PSL30

- To be used with Shelf Bracket, Inverted Bracket or Shelf Clips
- Part Number only includes shelf. Brackets sold separately.
- Replace "P" with an "S" for Stainless Steel

6" Deep		15" Deep	
Cat. No.	Width	Cat. No.	Width
PS2406-A	24"	PS2415-A	24"
PS3006-A	30"	PS3015-A	30"
PS3606-A	36"	PS3615-A	36"
PS4206-A	42"	PS4215-A	42"
PS4806-A	48"	PS4815-A	48"
PS5406-A	54"	PS5415-A	54"
PS6006-A	60"	PS6015-A	60"
PS6606-A	66"	PS6615-A	66"
PS7206-A	72"	PS7215-A	72"
9" Deep		18" Deep	
PS2409-A	24"	PS2418-A	24"
PS3009-A	30"	PS3018-A	30"
PS3609-A	36"	PS3618-A	36"
PS4209-A	42"	PS4218-A	42"
PS4809-A	48"	PS4818-A	48"
PS5409-A	54"	PS5418-A	54"
PS6009-A	60"	PS6018-A	60"
PS6609-A	66"	PS6618-A	66"
PS7209-A	72"	PS7218-A	72"
12" Deep		24" Deep	
PS2412-A	24"	PS2424-A	24"
PS3012-A	30"	PS3024-A	30"
PS3612-A	36"	PS3624-A	36"
PS4212-A	42"	PS4224-A	42"
PS4812-A	48"	PS4824-A	48"
PS5412-A	54"	PS5424-A	54"
PS6012-A	60"	PS6024-A	60"
PS6612-A	66"	PS6624-A	66"
PS7212-A	72"	PS7224-A	72"

Shelf Lips

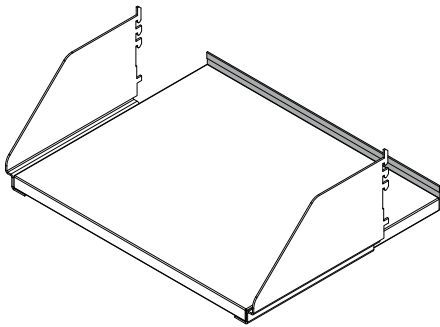

Shelf: PS3015-A
Brackets: PSB12L-A & PSB12R-A
Shelf Lip: PSL30

- To be used with any FlexCore Shelf
- Replace "P" with and "S" for Stainless Steel

Cat. No.	Width
PSL24-A	24"
PSL30-A	30"
PSL36-A	36"
PSL42-A	42"
PSL48-A	48"
PSL54-A	54"
PSL60-A	60"
PSL66-A	66"
PSL72-A	72"

Shelf Extender

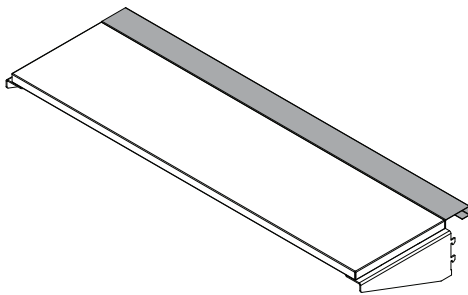

Shelf: PWS24875-A
Brackets: PWSB875L-A & PWSB875R-A
Shelf Extender: PSE24325-A

- To be used with any FlexCore Shelf
- Replace "P" with and "S" for Stainless Steel
- Note: Shelf Extender does not increase load rating of shelf

Cat. No.	Width
PSE24325-A	24"
PSE30325-A	30"
PSE36325-A	36"
PSE42325-A	42"
PSE48325-A	48"
PSE54325-A	54"
PSE60325-A	60"
PSE66325-A	66"
PSE72325-A	72"

FlexCore Accessories

White Marker Boards

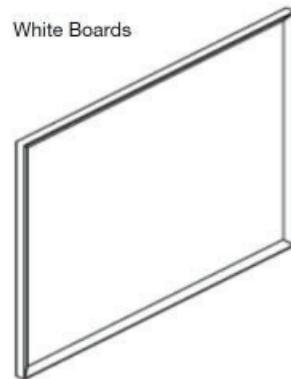
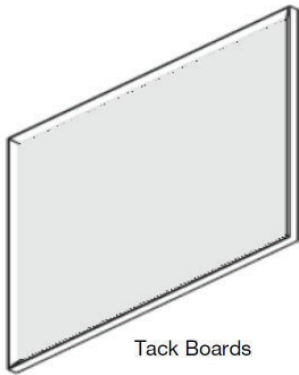

- To be used with any FlexCore Core
- Replace "P" with and "S" for Stainless Steel

Cat. No.		Width	Height
White Marker Board	Tack Board		
PWMB2411	PTBB2411	24"	11"
PWMB3011	PTBB3011	30"	11"
PWMB3611	PTBB3611	36"	11"
PWMB4211	PTBB4211	42"	11"
PWMB4811	PTBB4811	48"	11"
PWMB5411	PTBB5411	54"	11"
PWMB6011	PTBB6011	60"	11"
PWMB6611	PTBB6611	66"	11"
PWMB7211	PTBB7211	72"	11"
PWMB2424	PTBB2424	24"	24"
PWMB3024	PTBB3024	30"	24"
PWMB3624	PTBB3624	36"	24"
PWMB4224	PTBB4224	42"	24"
PWMB4824	PTBB4824	48"	24"
PWMB5424	PTBB5424	54"	24"
PWMB6024	PTBB6024	60"	24"
PWMB6624	PTBB6624	66"	24"
PWMB7224	PTBB7224	72"	24"
PWMB2430	PTBB2430	24"	30"
PWMB3030	PTBB3030	30"	30"
PWMB3630	PTBB3630	36"	30"
PWMB4230	PTBB4230	42"	30"
PWMB4830	PTBB4830	48"	30"
PWMB5430	PTBB5430	54"	30"
PWMB6030	PTBB6030	60"	30"
PWMB6630	PTBB6630	66"	30"
PWMB7230	PTBB7230	72"	30"

Keyboard Tray

Cat. No.	Type
KBTMP	Keyboard Tray with Mouse Pad

Monitor Arm

Cat. No.	Type
FC-MA	Monitor Arm

CPU Holder

Cat. No.	Type
FC-CPUH	CPU Holder

LED Task Lighting for FlexCore



- Touch and hold continuous dimming and 10 hour automatic turnoff
- Units with (1) light include: (1) LED task light, magnetic angle mount that allows for up to 25° adjustment, 60 watt power supply with magnetic mount and 6' white cord
- Units with (2) lights include: (2) LED task light, magnetic angle mount that allows for up to 25° adjustment, 60 watt power supply with magnetic mount, 6' white cord, and 1 interlink cord to connect lights
- 60 watt power supply with magnetic mount and 6' white cord
- Made with anodized aluminum
- Lasts up to 50,000 hours

Cat. No.	Quantity of Lights	Actual Width	For use with:
TL17-LED	1	17"	24" wide Core/Cart
TL17-LED	1	17"	30" wide Core/Cart
TL17-LED	1	17"	36" wide Core/Cart
TL17-LED	1	17"	42" wide Core/Cart
TL17-LED	1	17"	48" wide Core/Cart
TL17-LED	1	17"	54" wide Core/Cart
TL34-LED	2	17"	60" wide Core/Cart
TL34-LED	2	17"	66" wide Core/Cart
TL34-LED	2	17"	72" wide Core/Cart

FlexCore Process Table

FlexCore Process Table - Standard Duty with Leveling Glides

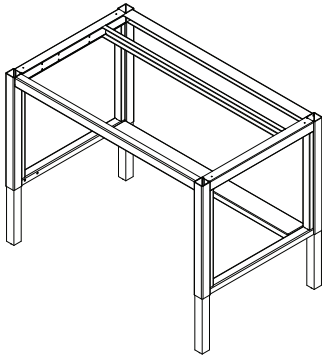

- Replace "P" with and "S" for Stainless Steel
- Height adjusts from 28"-38" in 1" increments, including 1" thick top
- Weight Capacity up to 600 lbs., UDL and includes the weight of the work surface and suspended cabinets

24" Deep	Cat. No.		Width
	30" Deep	36" Deep	
PLAT3624	PLAT3630	PLAT3636	36"
PLAT4224	PLAT4230	PLAT4236	42"
PLAT4824	PLAT4830	PLAT4836	48"
PLAT5424	PLAT5430	PLAT5436	54"
PLAT6024	PLAT6030	PLAT6036	60"
PLAT6624	PLAT6630	PLAT6636	66"
PLAT7224	PLAT7230	PLAT7236	72"

FlexCore Process Table - Standard Duty with Casters

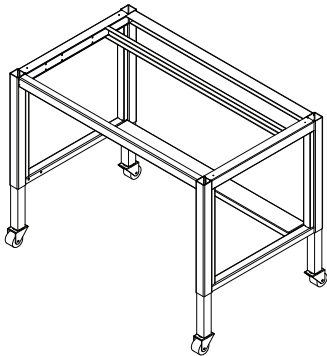

- Replace "P" with and "S" for Stainless Steel
- Height adjusts from 28"-38" in 1" increments, including 1" thick top
- Weight Capacity up to 600 lbs., UDL and includes the weight of the work surface and suspended cabinets

24" Deep	Cat. No.		Width
	30" Deep	36" Deep	
PMAT3624	PMAT3630	PMAT3636	36"
PMAT4224	PMAT4230	PMAT4236	42"
PMAT4824	PMAT4830	PMAT4836	48"
PMAT5424	PMAT5430	PMAT5436	54"
PMAT6024	PMAT6030	PMAT6036	60"
PMAT6624	PMAT6630	PMAT6636	66"
PMAT7224	PMAT7230	PMAT7236	72"

FlexCore Process Table

FlexCore Process Table - Heavy Duty with Leveling Glides

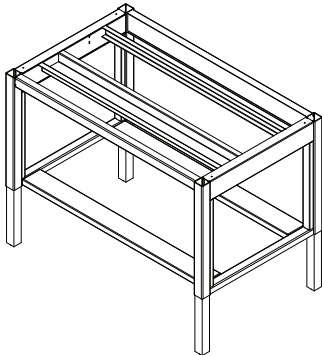

- Replace "P" with and "S" for Stainless Steel
- Height adjusts from 28"-38" in 1" increments, including 1" thick top
- Weight Capacity up to 1,200 lbs., UDL and includes the weight of the work surface and suspended cabinets

24" Deep	Cat. No.		Width
	30" Deep	36" Deep	
PLAT3624-HD	PLAT3630-HD	PLAT3636-HD	36"
PLAT4224-HD	PLAT4230-HD	PLAT4236-HD	42"
PLAT4824-HD	PLAT4830-HD	PLAT4836-HD	48"
PLAT5424-HD	PLAT5430-HD	PLAT5436-HD	54"
PLAT6024-HD	PLAT6030-HD	PLAT6036-HD	60"
PLAT6624-HD	PLAT6630-HD	PLAT6636-HD	66"
PLAT7224-HD	PLAT7230-HD	PLAT7236-HD	72"

FlexCore Process Table - Heavy Duty with Casters

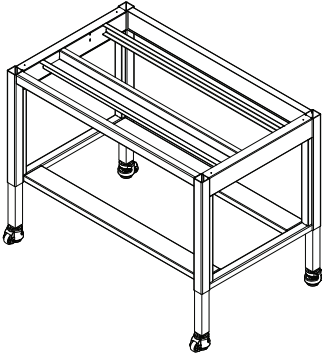

- Replace "P" with and "S" for Stainless Steel
- Height adjusts from 28"-38" in 1" increments, including 1" thick top
- Weight Capacity up to 1,200 lbs., UDL and includes the weight of the work surface and suspended cabinets

24" Deep	Cat. No.		Width
	30" Deep	36" Deep	
PMAT3624-HD	PMAT3630-HD	PMAT3636-HD	36"
PMAT4224-HD	PMAT4230-HD	PMAT4236-HD	42"
PMAT4824-HD	PMAT4830-HD	PMAT4836-HD	48"
PMAT5424-HD	PMAT5430-HD	PMAT5436-HD	54"
PMAT6024-HD	PMAT6030-HD	PMAT6036-HD	60"
PMAT6624-HD	PMAT6630-HD	PMAT6636-HD	66"
PMAT7224-HD	PMAT7230-HD	PMAT7236-HD	72"

FlexCore Services

Overhead Carrier

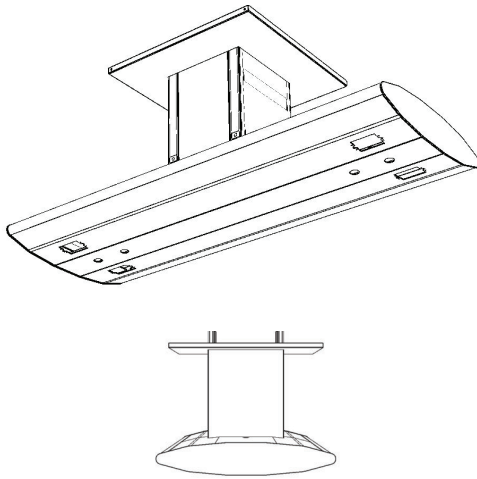

- Part number is a blank overhead service carrier
- Please contact your ICI representative to determine Overhead Service Carrier Cutouts

Cat. No.	Length
JPOHSC363624	36"
JPOHSC483624	48"
JPOHSC603624	60"

Examples of Overhead Service Carrier Configurations

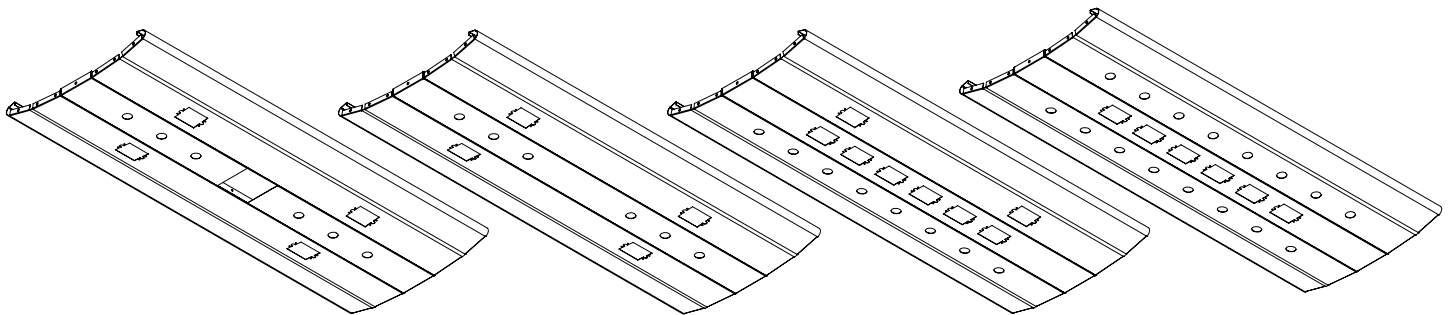

Service Pod

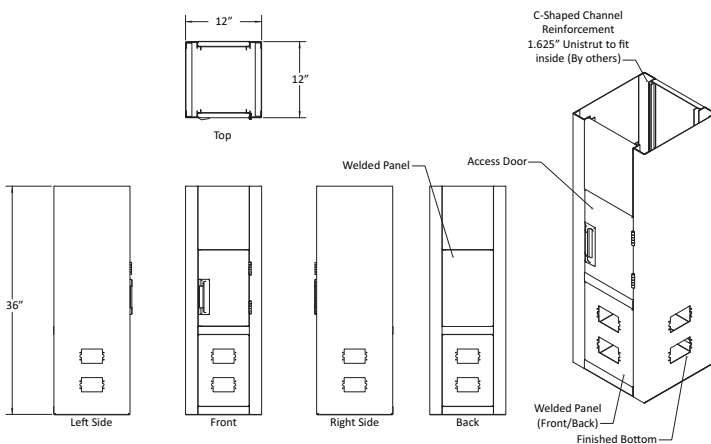

Cat. No.	Height
PCSC361212	36"
PCSC481212	48"
PCSC601212	60"

Quick Connect Outlets for Ceilings Panels

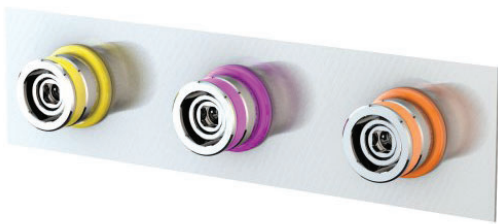

- Envision Plumbing Fitting Brass 3/8" MNPT to QC Body QCFL-B-3M-K (for ceiling panel)

Cat. No.	Type
E3PFWQBM-K1	Helium
E3PFWQBM-K2	Air
E3PFWQBM-K4	Vacuum
E3PFWQBM-K5	Gas
E3PFWQBM-K6	Natural Gas
E3PFWQBM-K7	Argon
E3PFWQBM-K8	Nitrogen
E3CPP	Ceiling Panel Plug Cover

Junction Box

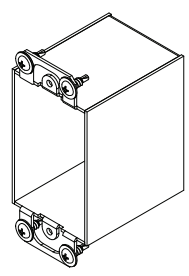

Cat. No.	Type
E3CPJB	J-Box

Electrical Box Assemblies

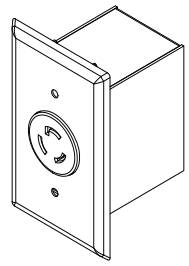

- Includes: Junction box, electrical outlet, stainless steel cover plate

Cat. No.	Type
E3CPL5-KIT	L5-20R
E3CPL14-KIT	L14-20R

Data Box Assemblies

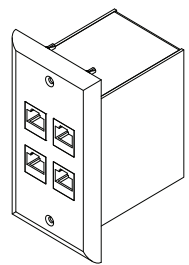

- Includes: Junction box, data outlet, stainless steel cover plate
- CAT-5E

Cat. No.	Type
E3CPD2-KIT	2 Data Outlets
E3CPD4-KIT	4 Data Outlets
E3CPD6-KIT	6 Data Outlets

Steel Suspended Cabinets

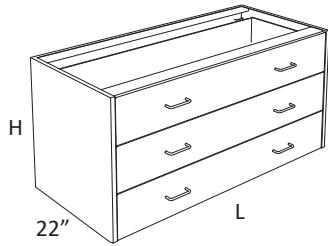

- Suspended Cabinets vary in height, see part number tables below
- Lengths are as shown
- See page 3 for cabinet styles and options
- Actual product dimensions may vary slightly due to style and hardware selection
- Each suspended cabinet furnished with complete hanging hardware

23.0625" High Suspended Open Cabinets

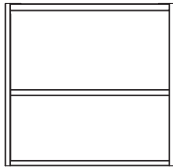

Cat. No.	Length
J801-12	12"
J801-15	15"
J801-18	18"
J801-21	21"
J801-24	24"
J801-30	30"
J801-36	36"
J801-42	42"
J801-48	48"

23.0625" High Suspended Door Cabinets

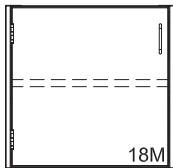

Cat. No.	Length
Left Hinged	
J803-12	12"
J803-15	15"
J803-18	18"
J803-21	21"
J803-24	24"

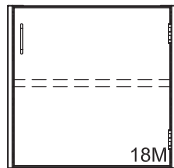

Cat. No.	Length
Right Hinged	
J802-12	12"
J802-15	15"
J802-18	18"
J802-21	21"
J802-24	24"

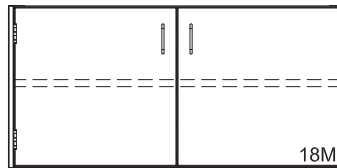

Cat. No.	Length
J804-30	30"
J804-36	36"
J804-42	42"
J804-48	48"

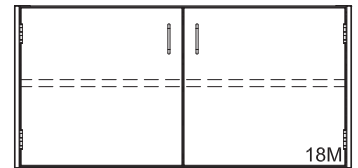

Sink cabinet with half back	
Cat. No.	Length
J881-30	30"
J881-36	36"
J881-42	42"
J881-48	48"

23.0625" High Suspended Drawer Cabinets

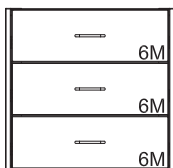

Cat. No.	Length
J818-15	15"
J818-18	18"
J818-21	21"
J818-24	24"

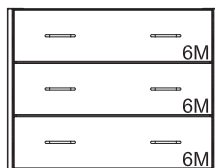

Cat. No.	Length
J818-30	30"
J818-36	36"
J818-42	42"
J818-48	48"

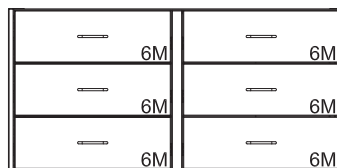

Cat. No.	Length
J823-30	30"
J823-36	36"
J823-42	42"
J823-48	48"

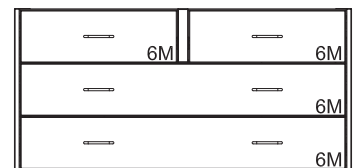

Cat. No.	Length
J826-30	30" L
J826-36	36" L
J826-42	42" L
J826-48	48" L

Steel Suspended Cabinets

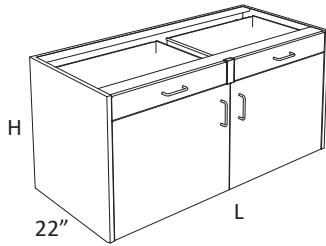

- Suspended Cabinets vary in height, see part number tables below
- Lengths are as shown
- See page 3 for cabinet styles and options
- Actual product dimensions may vary slightly due to style and hardware selection
- Each suspended cabinet furnished with complete hanging hardware

23.0625" High Suspended Drawer Cabinets

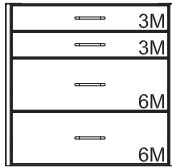

Cat. No.	Length
J820-15	15"
J820-18	18"
J820-21	21"
J820-24	24"

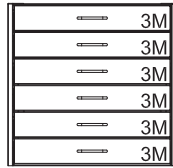

Cat. No.	Length
J821-15	15"
J821-18	18"
J821-21	21"
J821-24	24"

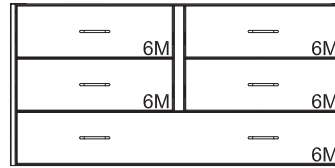

Cat. No.	Length
J827-30	30"
J827-36	36"
J827-42	42"
J827-48	48"

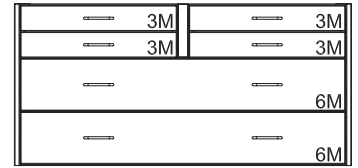

Cat. No.	Length
J828-30	30"
J828-36	36"
J828-42	42"
J828-48	48"

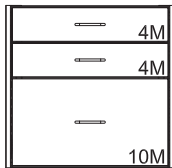

Cat. No.	Length
J822-15	15"
J822-18	18"
J822-21	21"
J822-24	24"

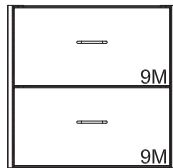

Cat. No.	Length
J833-15	15"
J833-18	18"
J833-21	21"
J833-24	24"

23.0625" High Suspended Combination Cabinets

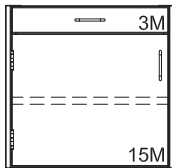

Cat. No.	Length
Left Hinged	
J806-15	15"
J806-18	18"
J806-21	21"
J806-24	24"

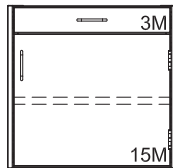

Cat. No.	Length
Right Hinged	
J805-15	15"
J805-18	18"
J805-21	21"
J805-24	24"

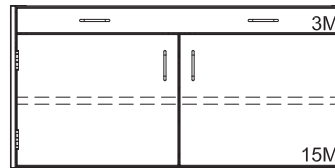

Cat. No.	Length
J807-30	30"
J807-36	36"
J807-42	42"
J807-48	48"

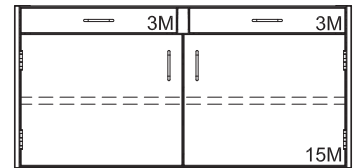

Cat. No.	Length
J808-30	30"
J808-36	36"
J808-42	42"
J808-48	48"

Steel Suspended Cabinets

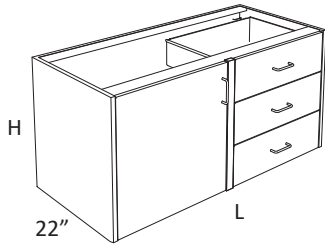

- Suspended Cabinets vary in height, see part number tables below
- Lengths are as shown
- See page 3 for cabinet styles and options
- Actual product dimensions may vary slightly due to style and hardware selection
- Each suspended cabinet furnished with complete hanging hardware

23.0625" High Suspended Combination Cabinets

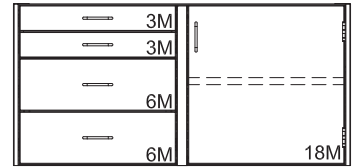
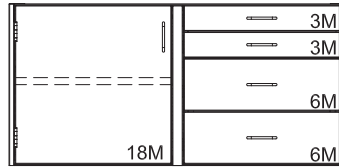
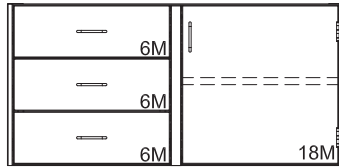
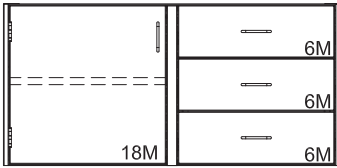

Cat. No.	Length
Left Cabinet	
J811-30	30"
J811-36	36"
J811-42	42"
J811-48	48"

Cat. No.	Length
Right Cabinet	
J810-30	30"
J810-36	36"
J810-42	42"
J810-48	48"

Cat. No.	Length
Left Cabinet	
J813-30	30"
J813-36	36"
J813-42	42"
J813-48	48"

Cat. No.	Length
Right Cabinet	
J812-30	30"
J812-36	36"
J812-42	42"
J812-48	48"

23.0625" High Suspended Corner Cabinet

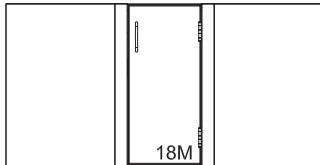

Cat. No.
Right Hinged
J829-32

Steel Suspended Cabinets

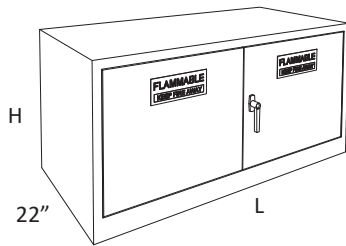

- Suspended Cabinets vary in height, see part number tables below
- Lengths are as shown
- Actual product dimensions may vary slightly due to style and hardware selection

23.0625" High Flammable Storage Suspended Cabinets

- Solvent Storage Cabinets are specifically designed for the storage of flammable and combustible liquids.
- Construction meets the requirements listed by UFC, OSHA and NFPA No. 30-1993 and are UL listed.
- A 2" deep liquid-tight pan covers the entire bottom of the cabinet to contain liquid leaks and spills. Two diametrically opposed vents with spark screens are provided in the back of the cabinet as well as a grounding screw.
- Cabinets are labeled: FLAMMABLE - KEEP FIRE AWAY

Manual Latch

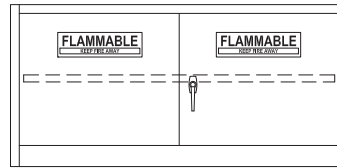
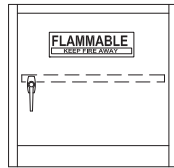
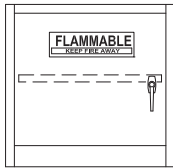

Cat. No.	Length
Left Hinged	
J830-18	18"
J830-24	24"

Cat. No.	Length
Right Hinged	
J831-18	18"
J831-24	24"

Cat. No.	Length
J831-30	30"
J831-36	36"
J831-42	42"
J831-48	48"

Steel Suspended Cabinets

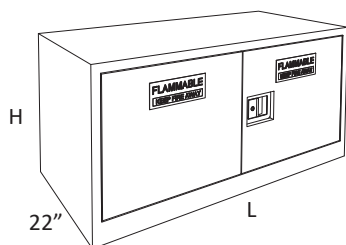

- Suspended Cabinets vary in height, see part number tables below
- Lengths are as shown
- Actual product dimensions may vary slightly due to style and hardware selection

23.0625" High Flammable Storage Base Cabinets

- Solvent Storage Cabinets are specifically designed for the storage of flammable and combustible liquids.
- Construction meets the requirements listed by UFC, OSHA and NFPA No. 30-1993 and are UL listed.
- A 2" deep liquid-tight pan covers the entire bottom of the cabinet to contain liquid leaks and spills. Two diametrically opposed vents with spark screens are provided in the back of the cabinet as well as a grounding screw.
- Cabinets are labeled: FLAMMABLE - KEEP FIRE AWAY
- Different options include doors that are self-closing and synchronized so that both doors will always fully close. The right hand door is equipped with a three-point latching system that automatically engages when the doors close.
- Each door can also be equipped with a fusible link hold-open feature that ensures the door closes should the temperature outside cabinet exceed 165°F.

Slam Latch

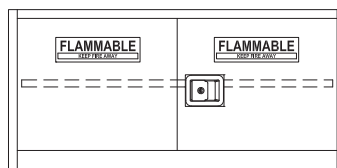
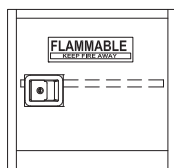
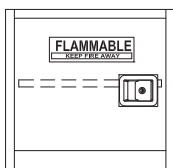

Cat. No.	Length
Left Hinged	
Slam Latch Handle	
J830-18SL	18"
J830-24SL	24"
Slam Latch Handle and Auto-closing Mechanism	
J830-18SLA	18"
J830-24SLA	24"
Slam Latch Handle, Auto-closing Mechanism and Fusible Links	
J830-18SLAS	18"
J830-24SLAS	24"

Cat. No.	Length
Right Hinged	
Slam Latch Handle	
J831-18SL	18"
J831-24SL	24"
Slam Latch Handle and Auto-closing Mechanism	
J831-18SLA	18"
J831-24SLA	24"
Slam Latch Handle, Auto-closing Mechanism and Fusible Links	
J831-18SLAS	18"
J831-24SLAS	24"

Cat. No.	Length
Slam Latch Handle	
J831-30SL	30"
J831-36SL	36"
J831-42SL	42"
J831-48SL	48"
Slam Latch Handle and Auto-closing Mechanism	
J831-30SLA	30"
J831-36SLA	36"
J831-42SLA	42"
J831-48SLA	48"
Slam Latch Handle, Auto-closing Mechanism and Fusible Links	
J831-30SLAS	30"
J831-36SLAS	36"
J831-42SLAS	42"
J831-48SLAS	48"
Slam Latch Handle, Auto-closing Mechanism, Fusible Links and Synchronized Doors	
J831-30SLASY	30"
J831-36SLASY	36"
J831-42SLASY	42"
J831-48SLASY	48"

Steel Suspended Cabinets

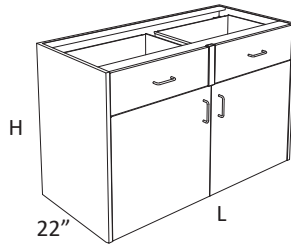

- Suspended Cabinets vary in height, see part number tables below
- Lengths are as shown
- See page 3 for cabinet styles and options
- Actual product dimensions may vary slightly due to style and hardware selection
- Each suspended cabinet furnished with complete hanging hardware

30.625" H - Open Suspended Cabinets

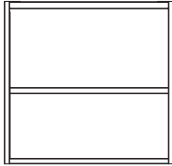

Cat. No.	Length
J840-12	12"
J840-15	15"
J840-18	18"
J840-21	21"
J840-24	24"
J840-30	30"
J840-36	36"
J840-42	42"
J840-48	48"

30.625" H - Door Suspended Cabinets

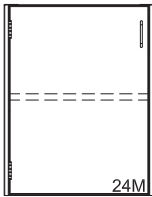

Cat. No.	Length
Left Hinged	
J841-12	12"
J841-15	15"
J841-18	18"
J841-21	21"
J841-24	24"

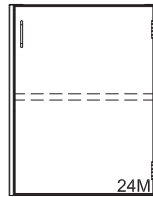

Cat. No.	Length
Right Hinged	
J842-12	12"
J842-15	15"
J842-18	18"
J842-21	21"
J842-24	24"

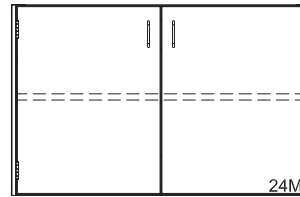

Cat. No.	Length
J843-30	30"
J843-36	36"
J843-42	42"
J843-48	48"

30.625" H - Drawer Suspended Cabinets

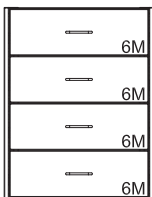

Cat. No.	Length
J859-15	15"
J859-18	18"
J859-21	21"
J859-24	24"



Cat. No.	Length
J860-30	30"
J860-36	36"
J860-42	42"
J860-48	48"

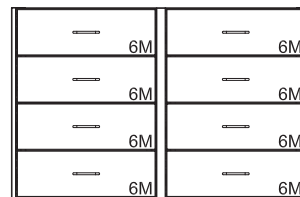

Cat. No.	Length
J861-30	30"
J861-36	36"
J861-42	42"
J861-48	48"

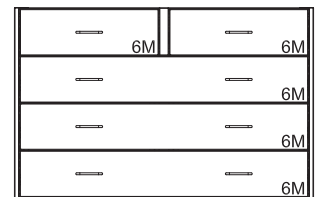

Cat. No.	Length
J865-30	30"
J865-36	36"
J865-42	42"
J865-48	48"

Steel Suspended Cabinets

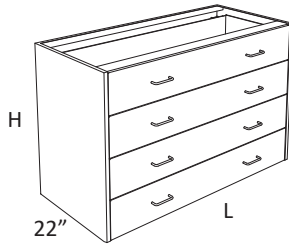

- Suspended Cabinets vary in height, see part number tables below
- Lengths are as shown
- See page 3 for cabinet styles and options
- Actual product dimensions may vary slightly due to style and hardware selection
- Each suspended cabinet furnished with complete hanging hardware

30.625" High Suspended Drawer Cabinets

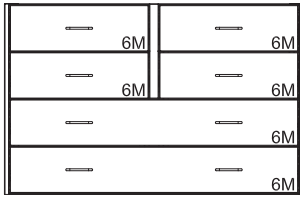

Cat. No.	Length
J866-30	30"
J866-36	36"
J866-42	42"
J866-48	48"

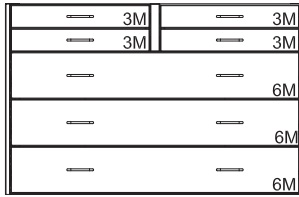

Cat. No.	Length
J867-30	30"
J867-36	36"
J867-42	42"
J867-48	48"

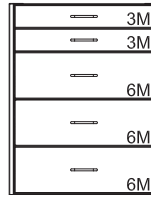

Cat. No.	Length
J862-15	15"
J862-18	18"
J862-21	21"
J862-24	24"

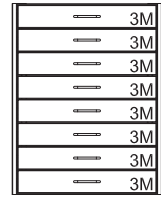

Cat. No.	Length
J863-15	15"
J863-18	18"
J863-21	21"
J863-24	24"

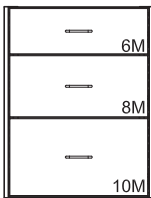

Cat. No.	Length
J864-15	15"
J864-18	18"
J864-21	21"
J864-24	24"

30.625" High Suspended Combination Cabinets

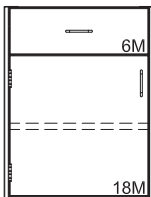

Cat. No.	Length
Left Hinged	
J844-15	15"
J844-18	18"
J844-21	21"
J844-24	24"

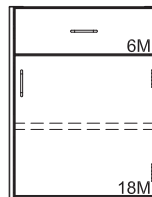

Cat. No.	Length
Right Hinged	
J845-15	15"
J845-18	18"
J845-21	21"
J845-24	24"

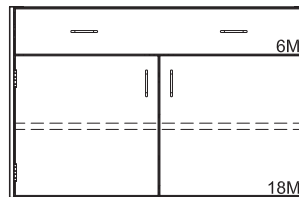

Cat. No.	Length
J846-30	30"
J846-36	36"
J846-42	42"
J846-48	48"

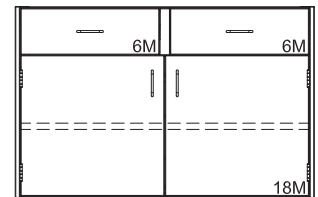

Cat. No.	Length
J847-30	30"
J847-36	36"
J847-42	42"
J847-48	48"

Steel Suspended Cabinets

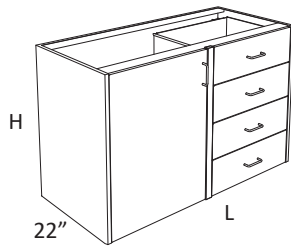

- Suspended Cabinets vary in height, see part number tables below
- Lengths are as shown
- See page 3 for cabinet styles and options
- Actual product dimensions may vary slightly due to style and hardware selection
- Each suspended cabinet furnished with complete hanging hardware

30.625" High Suspended Combination Cabinets

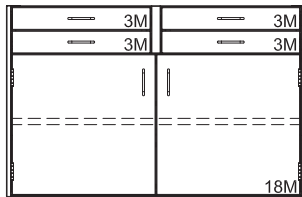

Cat. No.	Length
J848-30	30"
J848-36	36"
J848-42	42"
J848-48	48"

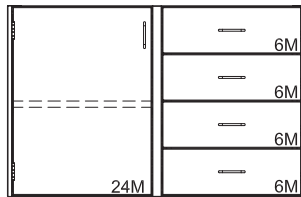

Cat. No.	Length
J849-30	30"
J849-36	36"
J849-42	42"
J849-48	48"

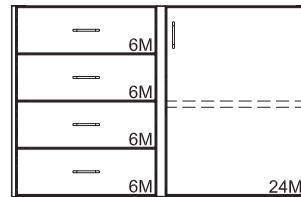

Cat. No.	Length
J850-30	30"
J850-36	36"
J850-42	42"
J850-48	48"

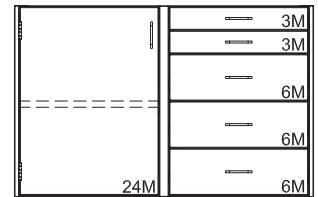

Cat. No.	Length
J851-30	30"
J851-36	36"
J851-42	42"
J851-48	48"

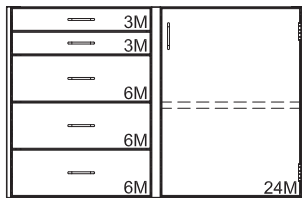

Cat. No.	Length
J852-30	30"
J852-36	36"
J852-42	42"
J852-48	48"

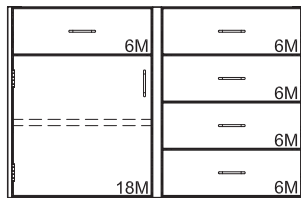

Cat. No.	Length
J853-30	30" L
J853-36	36" L
J853-42	42" L
J853-48	48" L

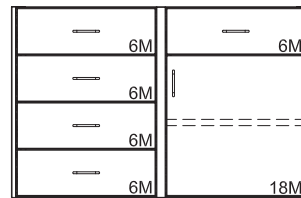

Cat. No.	Length
J854-30	30"
J854-36	36"
J854-42	42"
J854-48	48"

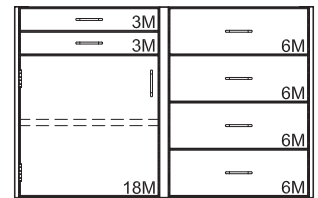

Cat. No.	Length
J855-30	30"
J855-36	36"
J855-42	42"
J855-48	48"

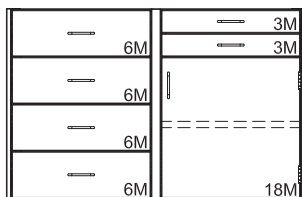

Cat. No.	Length
J856-30	30" L
J856-36	36" L
J856-42	42" L
J856-48	48" L

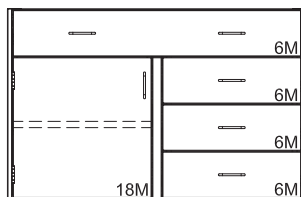

Cat. No.	Length
J857-30	30"
J857-36	36"
J857-42	42"
J857-48	48"

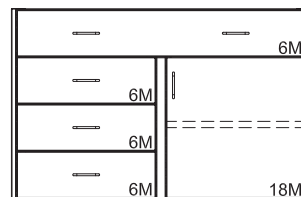

Cat. No.	Length
J858-30	30"
J858-36	36"
J858-42	42"
J858-48	48"

Steel Suspended Cabinets

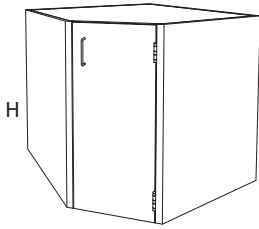

- Suspended Cabinets vary in height, see part number tables below
- Lengths are as shown
- See page 3 for cabinet styles and options
- Actual product dimensions may vary slightly due to style and hardware selection
- Each suspended cabinet furnished with complete hanging hardware

30.625" High Suspended Corner Cabinet

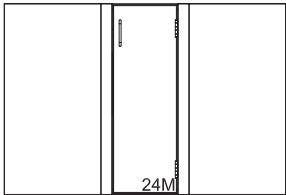

Cat. No.
Right Hinged
J868-32

Suspended Pencil Drawer

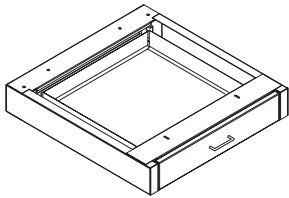

- 3 7/8" tall and 22" deep
- Designed to be hung from a table system
- Each suspended cabinet furnished with complete hanging hardware

Cat. No.	Length
JPPD1522	15"
JPPD1822	18"
JPPD2122	21"
JPPD2422	24"
JPPD3022	30"

Steel Mobile Cabinets

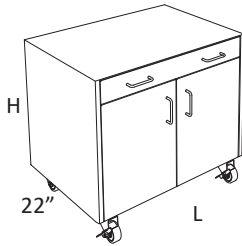

- Mobile Cabinets vary in height, see part number tables below
- Lengths are as shown
- See page 3 for cabinet styles and options
- Actual product dimensions may vary slightly due to style and hardware selection
- Includes (4) casters: (2) swivel, (2) fixed with locks
- Includes finished top & finished back, interlocking drawers and anti-tilt weights
- Weight capacity is 150 lb per caster

23.285" High Mobile Door Cabinets

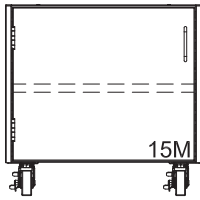

Cat. No.	Length
Left Hinged	
J1042-18	18"
J1042-24	24"

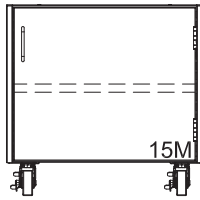

Cat. No.	Length
Right Hinged	
J1041-18	18"
J1041-24	24"

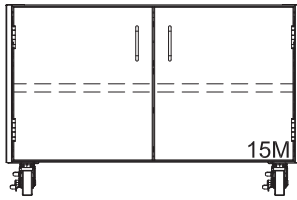

Cat. No.	Length
J1043-30	30"
J1043-36	36"

23.285" High Mobile Drawer Cabinets

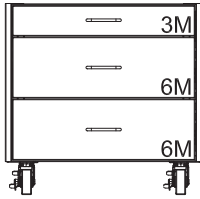

Cat. No.	Length
J1059-18	18"
J1059-24	24"

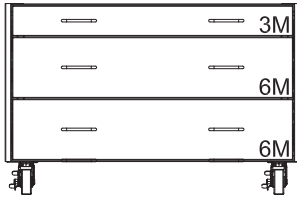

Cat. No.	Length
J1059-30	30"
J1059-36	36"

23.285" High Mobile Combination Cabinets

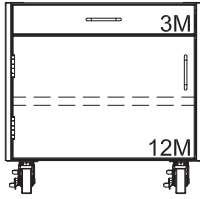

Cat. No.	Length
Left Hinged	
J1044-24	24"

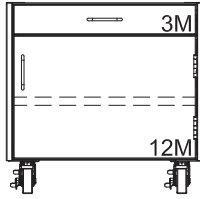

Cat. No.	Length
Right Hinged	
J1045-24	24"

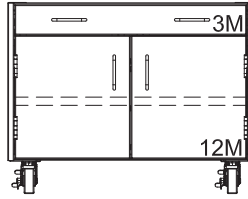

Cat. No.	Length
J1046-30	30"

Steel Mobile Cabinets

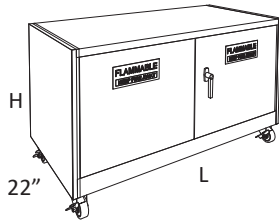

- Mobile Cabinets vary in height, see part number tables below
- Lengths are as shown
- See page 3 for cabinet styles and options
- Actual product dimensions may vary slightly due to style and hardware selection
- Includes (4) casters: (2) swivel, (2) fixed with locks
- Includes finished top & finished back, interlocking drawers and anti-tilt weights
- Weight capacity is 150 lb per caster

Flammable Storage Mobile Cabinets

- Solvent Storage Cabinets are specifically designed for the storage of flammable and combustible liquids.
- Construction meets the requirements listed by UFC, OSHA and NFPA No. 30-1993 and are UL listed.
- A 2" deep liquid-tight pan covers the entire bottom of the cabinet to contain liquid leaks and spills. Two diametrically opposed vents with spark screens are provided in the back of the cabinet as well as a grounding screw.
- Cabinets are labeled: FLAMMABLE - KEEP FIRE AWAY

Manual Latch

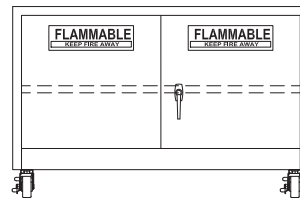
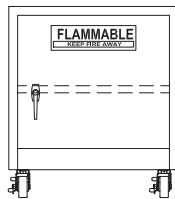
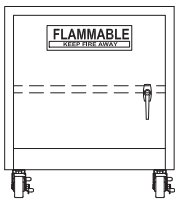

Cat. No.	Length
Left Hinged	
J897-18	18"
J897-24	24"

Cat. No.	Length
Right Hinged	
J899-18	18"
J899-24	24"

Cat. No.	Length
J899-30	30"
J899-36	36"
J899-42	42"
J899-48	48"

Steel Mobile Cabinets

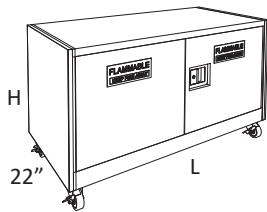

- Mobile Cabinets vary in height, see part number tables below
- Lengths are as shown
- See page 3 for cabinet styles and options
- Actual product dimensions may vary slightly due to style and hardware selection
- Includes (4) casters: (2) swivel, (2) fixed with locks
- Includes finished top & finished back, interlocking drawers and anti-tilt weights
- Weight capacity is 150 lb per caster

Flammable Storage Base Cabinets

- Solvent Storage Cabinets are specifically designed for the storage of flammable and combustible liquids.
- Construction meets the requirements listed by UFC, OSHA and NFPA No. 30-1993 and are UL listed.
- A 2" deep liquid-tight pan covers the entire bottom of the cabinet to contain liquid leaks and spills. Two diametrically opposed vents with spark screens are provided in the back of the cabinet as well as a grounding screw.
- Cabinets are labeled: FLAMMABLE - KEEP FIRE AWAY
- Different options include doors that are self-closing and synchronized so that both doors will always fully close. The right hand door is equipped with a three-point latching system that automatically engages when the doors close.
- Each door can also be equipped with a fusible link hold-open feature that ensures the door closes should the temperature outside cabinet exceed 165°F.

Slam Latch

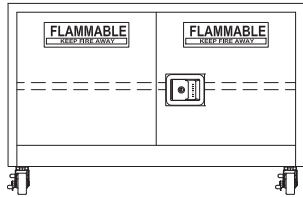
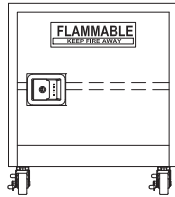
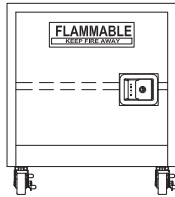

Cat. No.	Length
Left Hinged	
Slam Latch Handle	
J897-18SL	18"
J897-24SL	24"
Slam Latch Handle and Auto-closing Mechanism	
J897-18SLA	18"
J897-24SLA	24"
Slam Latch Handle, Auto-closing Mechanism and Fusible Links	
J897-18SLAS	18"
J897-24SLAS	24"

Cat. No.	Length
Right Hinged	
Slam Latch Handle	
J899-18SL	18"
J899-24SL	24"
Slam Latch Handle and Auto-closing Mechanism	
J899-18SLA	18"
J899-24SLA	24"
Slam Latch Handle, Auto-closing Mechanism and Fusible Links	
J899-18SLAS	18"
J899-24SLAS	24"

Cat. No.	Length
Slam Latch Handle	
J899-30SL	30"
J899-36SL	36"
J899-42SL	42"
J899-48SL	48"
Slam Latch Handle and Auto-closing Mechanism	
J899-30SLA	30"
J899-36SLA	36"
J899-42SLA	42"
J899-48SLA	48"
Slam Latch Handle, Auto-closing Mechanism and Fusible Links	
J899-30SLAS	30"
J899-36SLAS	36"
J899-42SLAS	42"
J899-48SLAS	48"
Slam Latch Handle, Auto-closing Mechanism, Fusible Links and Synchronized Doors	
J899-30SLASY	30"
J899-36SLASY	36"
J899-42SLASY	42"
J899-48SLASY	48"

Steel Mobile Cabinets

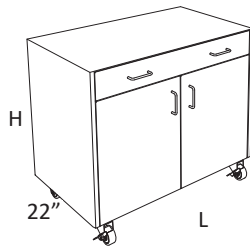

- Mobile Cabinets vary in height, see part number tables below
- Lengths are as shown
- See page 3 for cabinet styles and options
- Actual product dimensions may vary slightly due to style and hardware selection
- Includes (4) casters: (2) swivel, (2) fixed with locks
- Includes finished top & finished back, interlocking drawers and anti-tilt weights
- Weight capacity is 150 lb per caster

27.065" High Mobile Door Cabinets

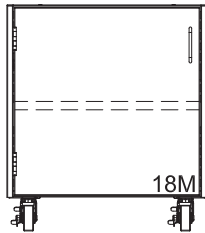

Cat. No.	Length
Left Hinged	
J1076-18	18"
J1076-24	24"

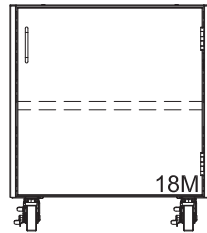

Cat. No.	Length
Right Hinged	
J1075-18	18"
J1075-24	24"

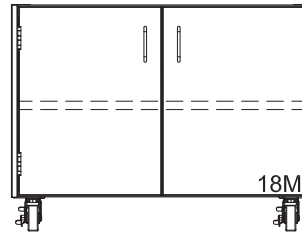

Cat. No.	Length
J1063-30	30"
J1063-36	36"

27.065" Mobile Drawer Cabinets

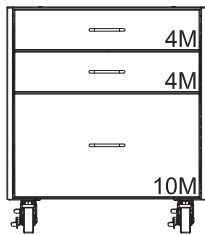

Cat. No.	Length
J1070-18	18"
J1070-24	24"

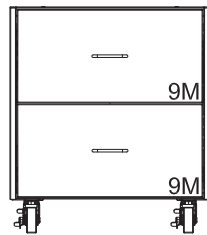

Cat. No.	Length
J1071-18	18"
J1071-24	24"

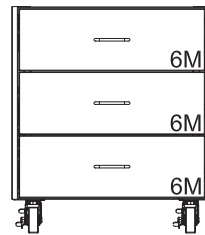

Cat. No.	Length
J1072-18	18"
J1072-24	24"



Cat. No.	Length
J1072-30	30"
J1072-36	36"

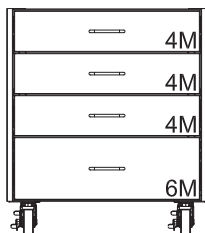

Cat. No.	Length
J1073-18	18"
J1073-24	24"

Steel Mobile Cabinets

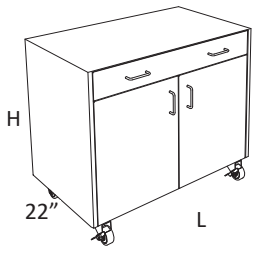

- Mobile Cabinets vary in height, see part number tables below
- Lengths are as shown
- See page 3 for cabinet styles and options
- Actual product dimensions may vary slightly due to style and hardware selection
- Includes (4) casters: (2) swivel, (2) fixed with locks
- Includes finished top & finished back, interlocking drawers and anti-tilt weights
- Weight capacity is 150 lb per caster

27.065" Mobile Combination Cabinets

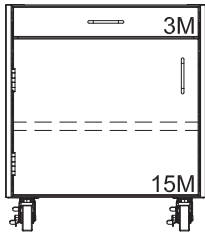

Cat. No.	Length
Left Hinged	
J1069-15	15"
J1069-18	18"
J1069-24	24"

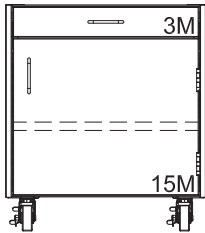

Cat. No.	Length
Right Hinged	
J1068-15	15"
J1068-18	18"
J1068-24	24"

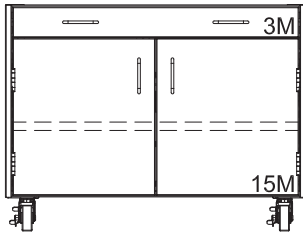

Cat. No.	Length
J1065-30	30"
J1065-36	36"

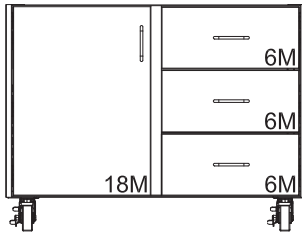

Cat. No.	Length
J1083-30	30"
J1083-36	36"
J1083-36	42"

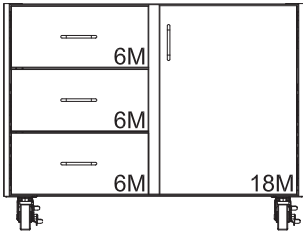

Cat. No.	Length
J1082-30	30"
J1082-36	36"
J1082-36	42"

Steel Mobile Cabinets

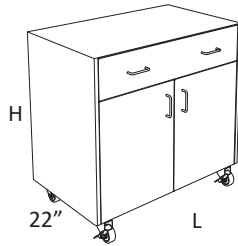

- Mobile Cabinets vary in height, see part number tables below
- Lengths are as shown
- See page 3 for cabinet styles and options
- Actual product dimensions may vary slightly due to style and hardware selection
- Includes (4) casters: (2) swivel, (2) fixed with locks
- Includes finished top & finished back, interlocking drawers and anti-tilt weights
- Weight capacity is 150 lb per caster

32.105" High Mobile Door Cabinets

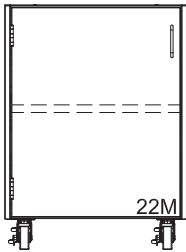

Cat. No.	Length
Left Hinged	
J1003-18	18"
J1003-24	24"

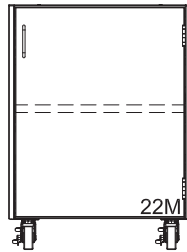

Cat. No.	Length
Right Hinged	
J1002-18	18"
J1002-24	24"

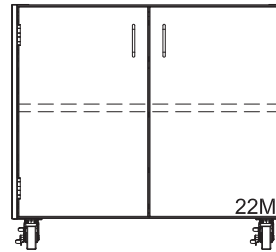

Cat. No.	Length
J1003-30	30"
J1003-36	36"
J1003-42	42"
J1003-48	48"

32.105" High Mobile Drawer Cabinets

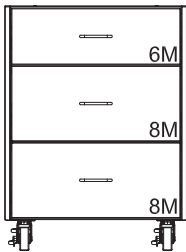

Cat. No.	Length
J1021-18	18"
J1021-24	24"

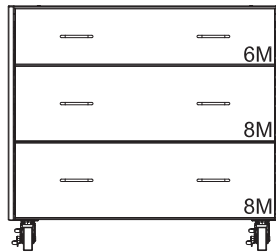

Cat. No.	Length
J1021-30	30"
J1021-36	36"

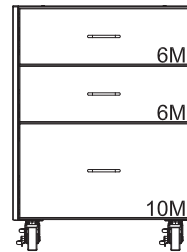

Cat. No.	Length
J1027-18	18"
J1027-24	24"

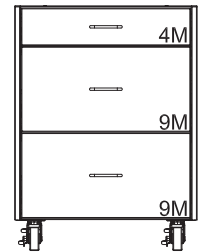

Cat. No.	Length
J1022-18	18"
J1022-24	24"

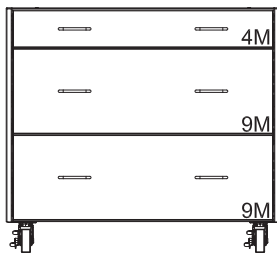

Cat. No.	Length
J1022-30	30"
J1022-36	36"

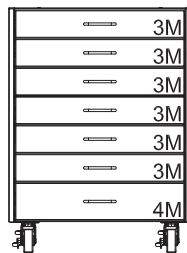

Cat. No.	Length
J1030-18	18"
J1030-24	24"

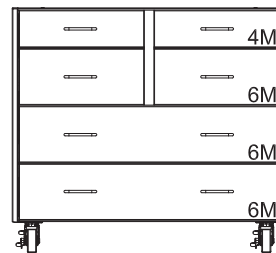

Cat. No.	Length
J1027-30	30"
J1027-36	36"
J1027-42	42"

Steel Mobile Cabinets

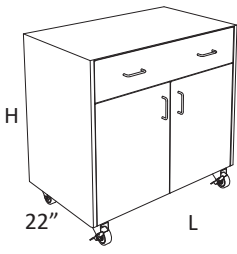

- Mobile Cabinets vary in height, see part number tables below
- Lengths are as shown
- See page 3 for cabinet styles and options
- Actual product dimensions may vary slightly due to style and hardware selection
- Includes (4) casters: (2) swivel, (2) fixed with locks
- Includes finished top & finished back, interlocking drawers and anti-tilt weights
- Weight capacity is 150 lb per caster

32.105" Mobile Combination Cabinets

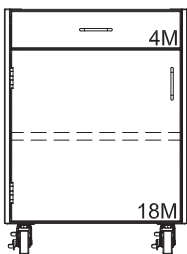

Cat. No.	Length
Left Hinged	
J1019-15	15"
J1019-18	18"
J1019-24	24"

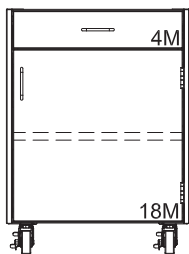

Cat. No.	Length
Right Hinged	
J1018-15	15"
J1018-18	18"
J1018-24	24"

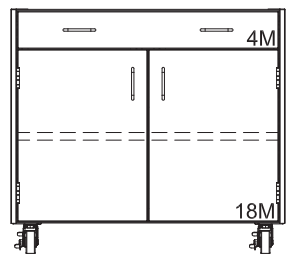

Cat. No.	Length
J1005-30	30"
J1005-36	36"
J1005-42	42"

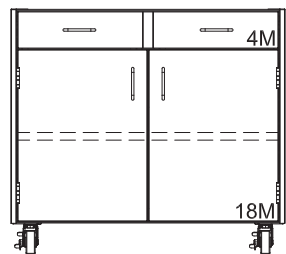

Cat. No.	Length
J1006-30	30"
J1006-36	36"
J1006-42	42"

Since ICI Scientific's inception, we have installed thousands of laboratory projects in sectors ranging from higher education, K-12, medical, pharmaceutical, industrial, and more. Our manufacturing culture of craftsmanship & design has driven the success of our laboratory projects since 1951. Experience shows through our quality.

Laboratory Products from ICI Scientific:



Steel Casework



Fume Hoods



Adaptable Furniture



Wood Casework



World Headquarters
1865 Highway 641 North
Paris, TN 38242-8814
Phone: 731-642-4251