

BT2800-231WSA Water Valve, Bench Mounted



Application: Laboratory water valve fitting for bench or countertop mounting.

Mounting: Turret base for bench mounting with locator pins.

Valve Body: Straight pattern forged brass.

Headwork: WaterSaver self-contained compression valve cartridge with replaceable stainless steel seat.

Handle: Molded nylon hooded style handle with index disc. Handle and index are color coded and marked per EN 13792.

Inlet: Furnished with G1/2 mounting shank, locknut and washer. G1/2 male inlet.

Outlet: G3/8 female outlet with removable anti-splash serrated hose end.

Quality Assurance: Fitting is fully assembled and factory tested prior to shipment. 10 bar (150 PSI) test pressure and maximum working pressure.



Single Valve
BT2800-231WSA

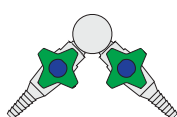

Two Valves at 90°
BT2800-232AWSA

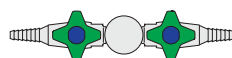

Two Valves at 180°
BT2800-232SWSA

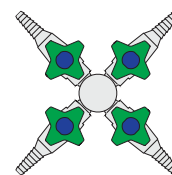

Four Valves
BT2800-234WSA

Ordering Information

Valve Construction Options	Valve Configurations			
	Single Valve	Two Valves at 90°	Two Valves at 180°	Four Valves
Compression valve cartridge	<input type="checkbox"/> BT2800-231WSA	<input type="checkbox"/> BT2800-232AWSA	<input type="checkbox"/> BT2800-232SWSA	<input type="checkbox"/> BT2800-234WSA
Ceramic disc valve cartridge	<input type="checkbox"/> BTC2800-231WSA	<input type="checkbox"/> BTC2800-232AWSA	<input type="checkbox"/> BTC2800-232SWSA	<input type="checkbox"/> BTC2800-234WSA
Internal check valve to prevent backflow	<input type="checkbox"/> BT2800CV-231WSA	<input type="checkbox"/> BT2800CV-232AWSA	<input type="checkbox"/> BT2800CV-232SWSA	<input type="checkbox"/> BT2800CV-234WSA

Product Finish

<input type="checkbox"/> WHT	Gloss white powder coated finish	<input type="checkbox"/> PCL	Polished chrome plated finish with clear epoxy coating
<input type="checkbox"/> GRY	Gloss light gray powder coated finish	<input type="checkbox"/> SCC	Satin chrome plated finish with clear epoxy coating
<input type="checkbox"/> GRD	Gloss dark gray powder coated finish	<input type="checkbox"/> SNC	Satin nickel plated finish with clear epoxy coating
<input type="checkbox"/> STM	Starburst metallic powder coated finish		

Note: Refer to "Product Finishes" catalog for complete information on finishes.

Media

BT2800-231WSA Water Valve, Bench Mounted

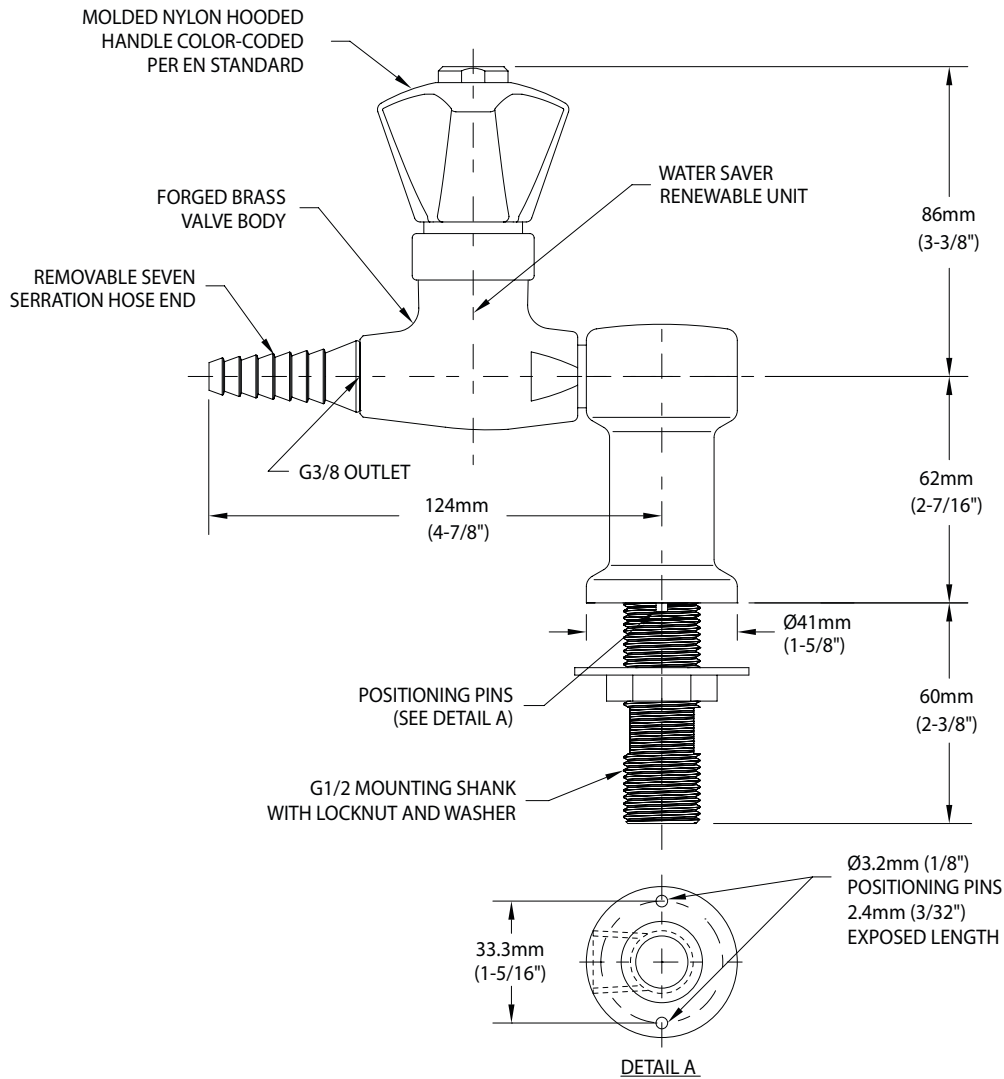

SINGLE VALVE:
BT2800-231WSA

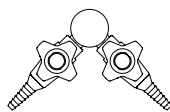

TWO VALVES AT 90°:
BT2800-232AWSA

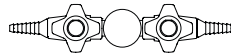

TWO VALVES AT 180°:
BT2800-232SWSA

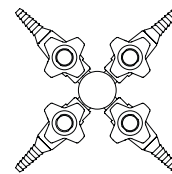

FOUR VALVES:
BT2800-234WSA

NOTES:

1. FITTING IS FULLY ASSEMBLED AND FACTORY TESTED PRIOR TO SHIPMENT.
2. MAXIMUM WORKING PRESSURE IS 10 BAR (150 PSI).

Rev. 052318

THIS SPACE FOR ARCHITECT/ENGINEER APPROVAL

Due to continuing product improvement, the information contained in this document is subject to change without notice. All dimensions are ± 6mm (1/4"). Rev. 071718