

TRIPLE THREAT

INTELLIGENT, ADAPTABLE, TOUGH







JLG[®]

JLG[®] High Capacity Telehandlers



GET MORE DONE

Job sites are harsh. Demanding. Conditions change without warning, and you need equipment that can keep up. JLG® telehandlers are designed and manufactured to the highest standards, so you can attack even the toughest challenges with the perfect blend of strength, versatility and smart technology. With these machines, you get the same benefits you've come to expect from JLG—quality, reliability and the highest resale values in the industry.



SUPERIOR CAB COMFORT

-  Tilt steering
-  Adjustable suspension seat and arm rest
-  Intuitive single joystick control
-  Excellent HVAC performance

INCREASED VERSATILITY AND EFFICIENCY

-  Inching feature automatically shifts the transmission into neutral when the service brake is depressed, allowing the operator to run the boom at maximum speed for faster delivery of loads at height
-  A cast counterweight and integrated tow hitch for added versatility on the job site
-  Industry-specific attachments for specialized applications

ENHANCED OPERATOR CONFIDENCE

-  Excellent visibility for a clear view of the job site around the machine
-  Optional reverse sensing system alerts the operator of rear obstructions with an audible alarm
-  Optional multifunction display puts important machine information like electronic capacity charts and diagnostics at the operator's fingertips



MANY TASKS, ONE MACHINE

High capacity telehandlers save time, money and labor on the job site by allowing operators to accomplish multiple tasks with one machine. Their higher lift capacity and enhanced versatility cut down on the time it takes to complete the work.

Industries like wind, oil and gas, steel erection, industrial construction and mining present unique challenges to equipment operators. With a wide range of specialized attachments, high capacity telehandlers can adapt to demanding job sites and replace other traditional machines. Plus, their ability to handle heavy, bulky loads makes them ideal for performing maintenance on other machines in the rental yard.

WARNING: PRODUCTIVITY AHEAD

Wide range of specialized attachments

Attachments for construction, wind, oil and gas, mining and more

Optional SmartLoad Technology

Combines attachment recognition with real-time load data

Precision gravity lowering and soft stop boom controls

Better boom control for more precision and fuel savings

Best-in-class cab

Work in more comfort with a spacious cab and intuitive controls

2-speed hydrostatic transmission and optional ride control

Improve load stability and promote smoother operation on uneven ground

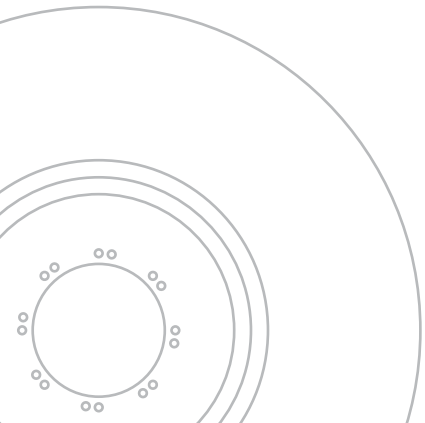

1644

Approximate Operating Weight	33,660 lb (15,265 kg)
Drive	4 x 4
Axle—Front	High-Bias, Limited Slip
Axle—Rear	Planetary
Steering	All-Wheel
Maximum Travel Speed	20 mph (32 km/h)
Frame Tilt Left/Right	±8 degrees

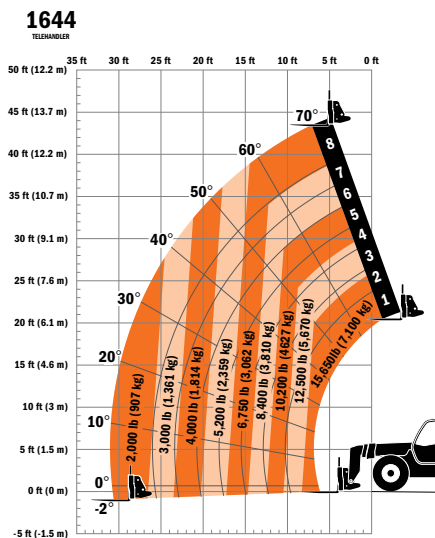
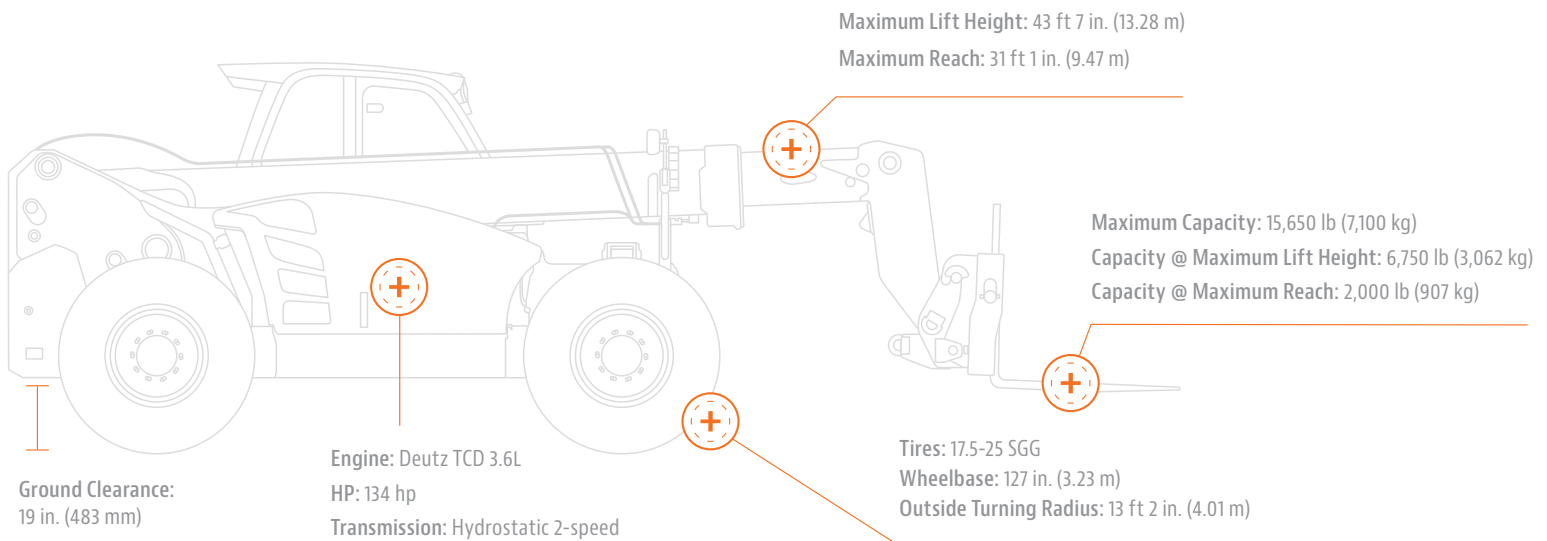

1732

Approximate Operating Weight	31,145 lb (14,127 kg)
Drive	4 x 4
Axle—Front	High-Bias, Limited Slip
Axle—Rear	Planetary
Steering	All-Wheel
Maximum Travel Speed	20 mph (32 km/h)
Frame Tilt Left/Right	±8 degrees

Maximum Capacity: 16,755 lb (7,600 kg)
 Capacity @ Maximum Lift Height: 9,900 lb (4,491 kg)
 Capacity @ Maximum Reach: 5,500 lb (2,495 kg)

Maximum Lift Height: 31 ft 8 in. (9.65 m)
 Maximum Reach: 18 ft 7 in. (5.66 m)

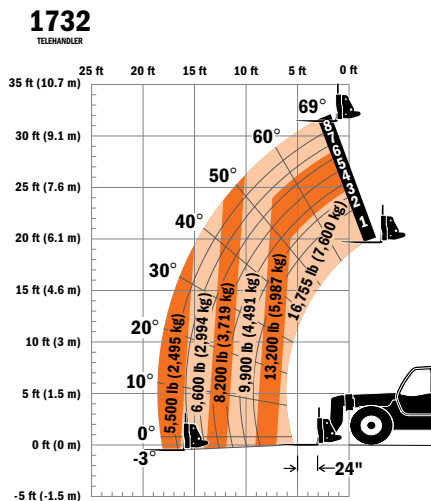
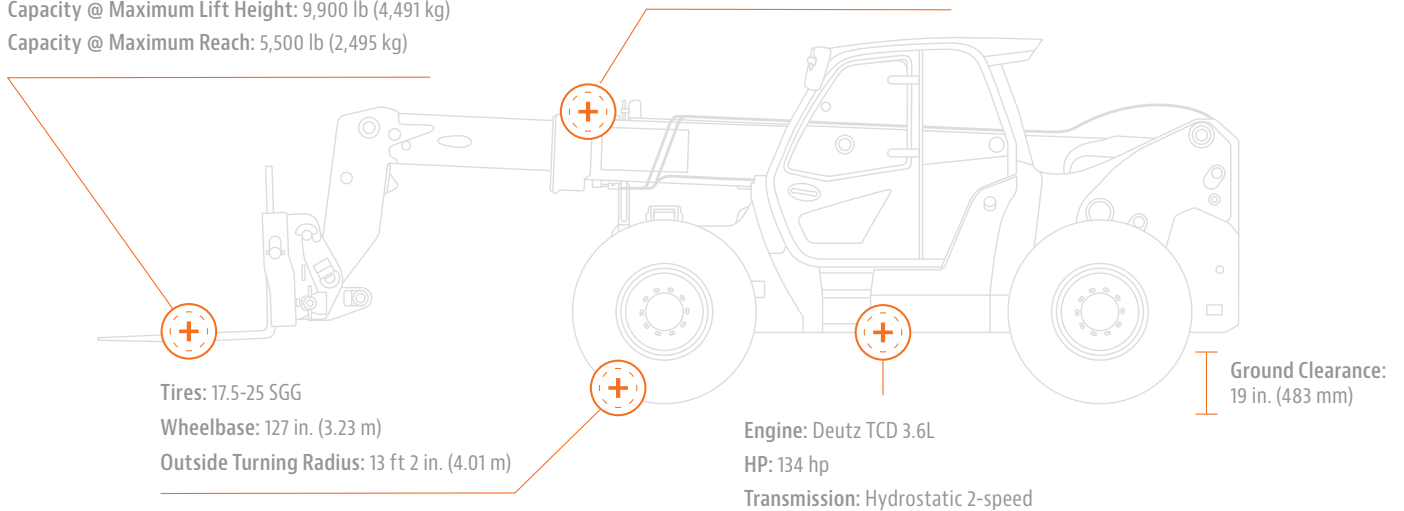

Length (Less Forks): 233 in. (5.92 m)

Height: 105 in. (2.67 m)

Width: 97 in. (2.46 m)

MORE ATTACHMENTS, MORE VERSATILITY

JLG offers a wide range of attachments to fit their high capacity telehandlers, from standard carriages to highly specialized tools. Designed for use in industries like industrial construction, logging, mining and wind, these attachments are manufactured with the same quality and reliability as the machines they work with to help you get the job done more efficiently.



Bale Clamp

For picking, carrying and placing large square bales



Bale Cradle

For picking, carrying and placing large round bales



Dual Fork Positioning Carriage

Adjust each fork position independently to handle various palletized loads without leaving the cab



Pallet Forks

Rugged design makes it easier to handle heavy palletized material



Side-Shift Carriage with Dual Fork Positioning

Adjust fork position independently; use left and right carriage shift to handle palletized loads from inside the cab



Standard Carriage

Forks that are fully floating and adjustable side-to-side for efficient load entry and exit



Log Handler

For handling multiple logs or a large single log



Pipe Grapple

For handling multiple pipes or a larger single pipe



Coupler Mounted Hook

For lifting and lowering objects



Material Handling Arm

Designed for lifting and placing objects around the job site

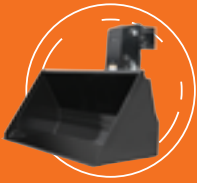

General Purpose Bucket

Used to clean up the job site, to spread materials and for loading and leveling



Grapple Bucket

Uses hydraulic arms to secure bulky loads and is useful for cleaning debris from job sites



Light Material Bucket

Used to clean up the job site, spread gravel or for loading and leveling

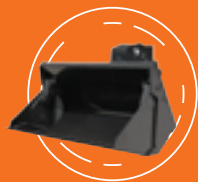

Multi-Purpose 4-in-1 Bucket

Can be used for loading, leveling, bottom dumping or as a grapple bucket

ADDITIONAL ATTACHMENTS

Coupler Mounted Winch

Can be used to set trusses and wall sections for wood and steel building construction

Steel Coil Handler

For transporting steel coils and cables



Part No. 3132250
Printed in USA

JLG Industries, Inc.
1 JLG Drive
McConnellsburg, PA 17233-9533
Telephone 717-485-5161
Toll-free in US 877-JLG-LIFT
Fax 717-485-6417
www.jlg.com
An Oshkosh Corporation Company