

Section 2

AMERICAN Pipe Joints





AMERICAN Joints for Pipe and Fittings

AMERICAN Fastite® Joint, 4"-64"

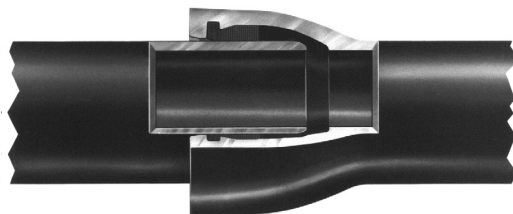

The AMERICAN Fastite Joint, furnished in sizes 4"-64", is a flexible, rubber ring compression-type joint used extensively in underground service. See pages 2-6 through 2-15 and Sections 3, 4, 7 and 9.

AMERICAN Fastite® Joint with Fast-Grip® Gasket, 4"-30"

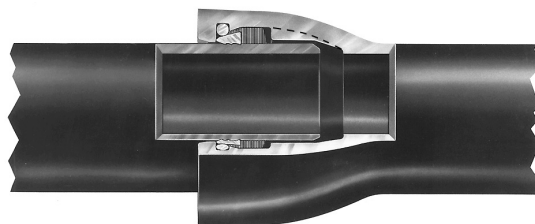

The AMERICAN Fast-Grip Gasket furnished in sizes 4"-30" provides flexible, field-adaptable joint restraint in a standard AMERICAN Fastite (or Flex-Ring) Bell. See Sections 4 and 9.

AMERICAN Flex-Ring® Joint, 4"-12"

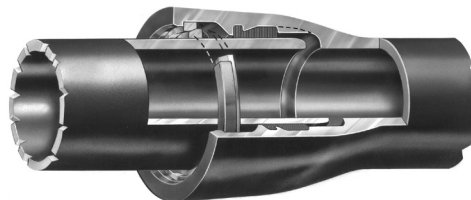

The AMERICAN Flex-Ring Joint provides flexible joint restraint against thrust due to internal water working pressure or external forces. It is also used in horizontal directional drilling (HDD) and pipe bursting applications. See Sections 4 and 9.



AMERICAN Joints for Pipe and Fittings

AMERICAN Flex-Ring® Joint, 14"-48"

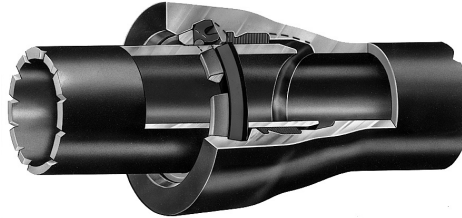

The AMERICAN Flex-Ring Joint provides flexible joint restraint against thrust due to internal water working pressure or external forces. It is also used in horizontal directional drilling (HDD) and pipe bursting applications. See Sections 4 and 9.

AMERICAN Field Flex-Ring®, 14"-36"

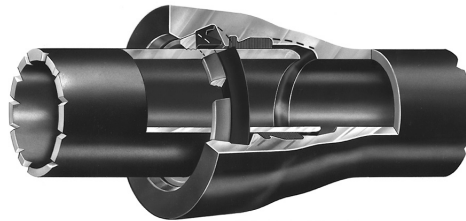

The AMERICAN Field Flex-Ring provides dependable and flexible field-adaptable restraint against thrust due to external forces or internal water working pressure in the standard Flex-Ring joint. This joining structure is also recommended at locations where field cutting is required in 14"-36" Flex-Ring piping. See Sections 4 and 9.

AMERICAN Lok-Ring® Joint, 54"-64"

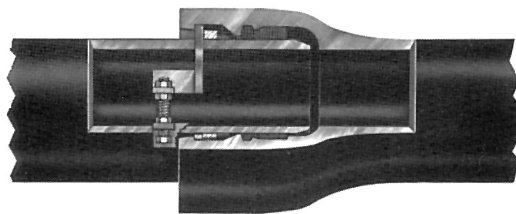

The AMERICAN Lok-Ring Joint is furnished in sizes 54"-64" and provides flexible joint restraint against thrust due to internal water working pressure. See Sections 4 and 9.



AMERICAN Joints for Pipe and Fittings

AMERICAN Mechanical Joint, 4"-48"

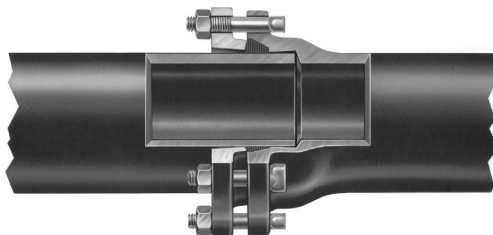

The AMERICAN Mechanical Joint, furnished in pipe sizes 4" -12" and in fittings sizes 4" -48", is a flexible stuffing box type connection used primarily in underground service.

See pages 2-16 through 2-21 and Sections 3, 5, 7 and 9.

AMERICAN MJ Coupled Joint, 4"-48"

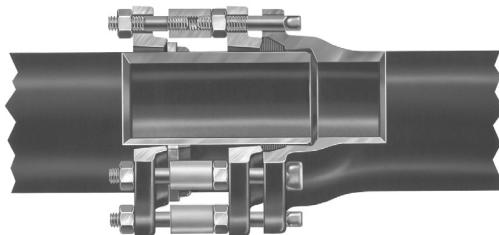

The AMERICAN MJ Coupled Joint is furnished in sizes 4" -48" and is an adaptation of the standard Mechanical Joint to provide joint restraint against thrust due to internal pressure.

See Section 9.

AMERICAN Flanged Joint, 4"-64"

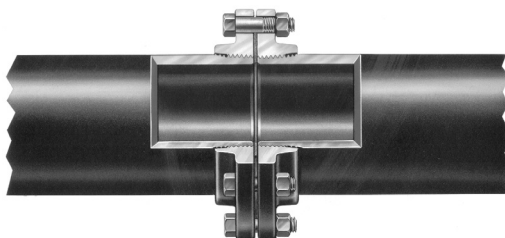

The AMERICAN Flanged Joint, furnished in sizes 4" -64", is widely used for exposed plant piping. In combination with other joints and with AMERICAN's recommended NSF 61 certified Toruseal® gasket, it is also commonly used for Long Span installations.

See Sections 6, 7 and 8.



AMERICAN Joints for Pipe and Fittings

AMERICAN Flex-Lok® Joint, 4"-24"

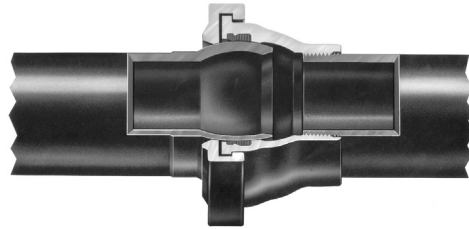

The AMERICAN Flex-Lok Joint, furnished in sizes 4"-24", is a boltless, very flexible joint. This joint is designed to provide up to 15° joint deflection for subaqueous or other difficult installations.
See Section 10.

AMERICAN Flex-Lok® Joint, 30"-60"



The AMERICAN Flex-Lok Joint, furnished in sizes 30"-60", is a boltless, very flexible joint. This joint is designed to provide up to 15° joint deflection for subaqueous or other difficult installations. Contact AMERICAN for 64" size requirements.
See Section 10.



AMERICAN Joints for Pipe and Fittings

AMERICAN Grooved and Shouldered Joint, 4"-64"

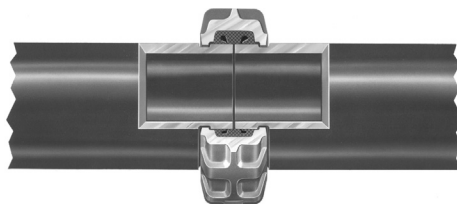

The AMERICAN Grooved Joint pictured above—and to a limited extent the Shouldered Joint (not pictured)—are furnished for some plant piping installations. See Section 2.

AMERICAN Fastite® Joint Push-Bar™ Pipe, 4"-64"

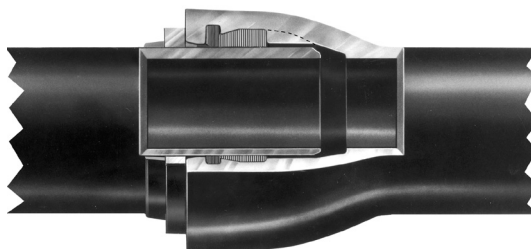

AMERICAN Fastite Joint Push-Bar pipe, furnished in sizes 4"-64", allows the AMERICAN Fastite Joint to be used in trenchless installations using direct jacking or pushing (including high load installations such as microtunneling and some pipe bursting applications). See Section 7.



AMERICAN Fastite® Joint Pipe For Water, Sewage or Other Liquids

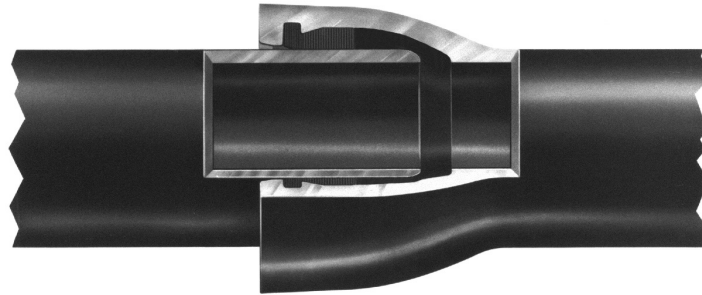

AMERICAN Fastite Joint Pipe in sizes 4" -64" for water, sewage or other liquids has the proven long-life and high-strength qualities inherent in pipe produced centrifugally in accordance with AWWA C151. In addition, this significant AMERICAN development, a dependable, single gasket, push-on type joint meeting the requirements of AWWA C111, affords the customer lower joint cost and time-saving advantages in installation. It provides exceptional strength and flexibility and has been widely accepted by engineers, contractors and utility officials since the 1950s. For added flexibility during construction, and for possible elimination of bends, a liberal 5° allowable deflection is standard in all sizes through 30", offering 21" offset in a 20' length of pipe. Liberal deflection can also be provided in larger diameter pipe with standard and Special Fastite Deflection Bells.

The patented AMERICAN Fastite Joint embodies many advanced design features and is rated for a water working pressure of 350 psi. For specific conditions, ductile iron piping with this joint has been approved for much higher pressure conditions. The socket, which is scientifically designed with two gasket recesses and a dividing buttress, is manufactured to close tolerances so that the gasket is self-centered, securely confined, and firmly compressed for a permanent, tight, trouble-free joint. The Fastite joint seal, bubble-tight under vacuum and external pressure, becomes even tighter with the application of internal pressure due to a specially designed wedging surface in the socket.

Fastite Joint Assembly

The bell opening is slightly tapered to provide easy entry of the pipe end; the flared socket design permits liberal joint deflection. The

plain end of the pipe is tapered or rounded to facilitate entry into the bell and self-centering in the gasket. On pipe cut in the field, the plain end can be easily beveled and smoothed by the use of a portable grinding wheel or other suitable apparatus. Methods of cutting ductile iron pipe are described in Section 3.

A stripe is painted on the plain end of AMERICAN Fastite Joint Pipe to provide a visual means of checking the joint alignment and to assure proper insertion. See page 2-10 for detailed assembly instructions.

Fastite Gasket

The Fastite Joint sealing component—a molded synthetic rubber ring gasket of two hardnesses, shaped to fit the configuration of the gasket socket—is manufactured per all requirements of ANSI/AWWA C111/A21.11 and under AMERICAN's own rigid specifications, assuring closely controlled dimensional and hardness properties. The smaller end of the gasket is of harder rubber, approximately 85 durometer hardness, which provides a strong shoulder for self-centering on the gasket buttress, a permanent seal against cold flow, and protection from deterioration. The larger end of the gasket is of softer rubber, approximately 65 durometer hardness, providing ease of assembly and positive sealing. The design assures effective sealing at low or high pressures and in straight or deflected joint alignment. It also eliminates any concerns of infiltration or root intrusion, and assures positive sealing against negative pressure, thus preventing gasket "pullout" should a vacuum be created in the line.

A taper on the inside of the gasket allows the entering pipe to locate and center on the hard section and along with a coated and



lubricated spigot reduces friction loads during subsequent assembly. The snug fit and the hard section of the gasket, in conjunction with the design of the buttress, act to restrain the gasket against dislodgment during assembly. Additional internal pressure results in increased tightness of the seal when pipe is either in straight alignment or deflected.

Gaskets made of SBR (Styrene Butadiene Rubber) are standard. For information on gaskets made of special types of rubber, for applications involving air or liquid temperatures in excess of 150°F, or for chemical, hydrocarbon or other special service applications, and for installations in contaminated soils where permeation through gaskets might be a concern, consult AMERICAN for recommendations. See Table 2-1.

Fastite Lubricant

AMERICAN Fastite Joint Lubricant is a non-toxic water soluble material imparting neither taste nor odor to the conveyed water and is ANSI/NSF 61 approved. The lubricant is suitable

for use in hot or cold weather and will adhere to wet or dry pipe. AMERICAN Fastite Joint Pipe can be assembled when submerged, though for such installation, special AMERICAN underwater joint lubricant is recommended. See Table No. 2-5 for appropriate lubricant quantities.

Fastite Joint Materials

Standard joint materials include Fastite plain rubber gaskets and a sufficient supply of Fastite joint lubricant. Fastite pipes are most often readily joined with available excavating equipment; however, assembly tools can be supplied by AMERICAN on a loan basis with a nominal deposit which is refundable upon return of tools in good condition.

Coating and Lining

AMERICAN Fastite Joint Pipe can be furnished asphaltic coated, cement lined, or with special coating or lining where required. See Section 11.

Fastite Gaskets

Table No. 2-1

Common Name or Trade Name*	Chemical Name	Maximum Service Temperature**		Common Uses
		Water & Sewer	Air	
Plain Rubber	Styrene Butadiene Copolymer(SBR)	150°F	150°F	Fresh Water, Salt Water, Sanitary Sewage
Plain Rubber (conductive)	Styrene Butadiene Copolymer(SBR)	150°F	150°F	Electrical continuity for thawing of Service Water and Sewage
EPDM	Ethylene Propylene Diene Monomer	212°F	200°F	Water, Sewage, Ketones, Dilute Acids and Alkalies, Vegetable Oil, Alcohols, Air
Neoprene	Polychloroprene(CR)	200°F	180°F	Fresh Water, Sewage
Nitrile Buna-N	Acrylonitrile Butadiene(NBR)	150°F	150°F	Non-Aromatic Hydrocarbons, Petroleum Oil, Hydraulic Fluids, Fuel Oil, Fats, Oil, Grease†
Fluoroelastomer Fluorel Viton®***	FKM	212°F	300°F	Aromatic Hydrocarbons, Gasoline, Refined Petroleum Products, most Chemicals and Solvents, High Temp., Air (Least permeable of all available Fastite gasket rubbers)

*AMERICAN reserves the right to furnish any Trade or Brand rubber for the chemical formulation specified.
 Temperature is in reference to conveyed fluid. **Lubricating oil in air can adversely affect SBR and EPDM performance. SBR, Nitrile and Neoprene are not recommended for hot air exposure in wastewater treatment systems.
 ***Viton® is a registered trademark of DuPont Dow Elastomers.
 Refer to Section 11 for temperature and service capabilities of pipe linings.
 Refer higher temperatures or other special requirements to AMERICAN for recommendations regarding suitable gasket material.
 †This gasket rubber is chemically resistant in the non-potable water uses shown but is not as resistant to permeation in potable water applications as FKM.
 All Fastite gaskets made from the materials in the above table are suitable for use with water containing normal concentrations of chloramine. Where increased resistance to chloramine is desired, neoprene or fluoroelastomer materials should be considered.



**AMERICAN Fastite® Joint
for Ductile Iron Pipe
ANSI/AWWA C111/A21.11
Standard Dimensions**

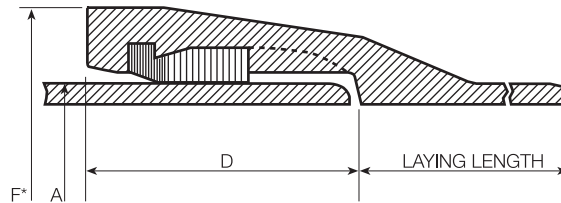

Table No. 2-2

Size in.	Nominal Laying Length ft.	Dimensions in Inches		
		A Outside Diameter	D Depth of Socket	F* Bell O.D.
4	20	4.80	3.31	6.40
6	20	6.90	3.38	8.60
8	20	9.05	3.75	10.96
10	20	11.10	3.75	13.12
12	20	13.20	3.75	15.22
14	20	15.30	5.23	17.61
16	20	17.40	5.23	19.74
18	20	19.50	5.50	22.16
20	20	21.60	5.50	24.28
24	20	25.80	5.50	28.50
30	20	32.00	6.50	34.95
36	20	38.30	6.50	41.37
42	20	44.50	7.50	48.27
48	20	50.80	8.00	54.71
54	20	57.56	8.50	61.65
60	20	61.61	8.75	65.80
64	20	65.67	9.00	70.04

*Dimensions subject to change at our option. Check AMERICAN if exact dimensions required.
See Section 3 for additional information on ductile iron pipe.
See Sections 4 and 7 for information on Fastite fittings.



AMERICAN Fastite® Joint Pipe
Allowable Joint Deflection

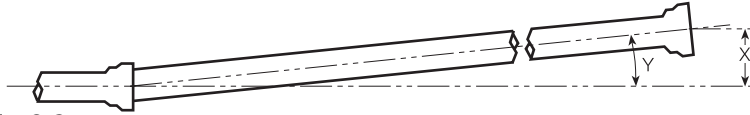

Table No. 2-3

Size in.	Nominal Laying Length ft.	Maximum Recommended Deflection†					
		Standard Bell			Special Deflection Bell		
		X Offset per Nominal Length in.	Y Deflection Angle	Radius of Curve* ft.	X Offset per Nominal Length in.	Y Deflection Angle	Radius of Curve* ft.
4	20	21	5°	230	—	—	—
6	20	21	5°	230	—	—	—
8	20	21	5°	230	—	—	—
10	20	21	5°	230	—	—	—
12	20	21	5°	230	—	—	—
14	20	21	5°	230	—	—	—
16	20	21	5°	230	—	—	—
18	20	21	5°	230	—	—	—
20	20	21	5°	230	—	—	—
24	20	21	5°	230	—	—	—
30	20	21	5°	230	—	—	—
36	20	17	4°	285	21	5°	230
42	20	12	3°	380	21	5°	230
48	20	12	3°	380	17	4°	285
54	20	12	3°	380	17	4°	285
60	20	12	3°	380	17	4°	285
64	20	12	3°	380	17	4°	285

*Approximate radius of curve produced by a succession of nominal lengths of pipe fully deflected.

†Special Deflection Bells must be specifically ordered and will be marked with white bell face for easy identification.

For easiest assembly, the joints should be assembled with the pipe in reasonably straight alignment. After joint assembly, the pipe may be deflected up to the maximum shown above. Offset distances are based on 20-ft lengths.

Maximum Allowable Separation

Table No. 2-4

Size in.	S Separation in.
4	3/8
6	9/16
8	3/4
10	15/16
12	1 1/8
14	1 5/16
16	1 1/2
18	1 5/8
20	1 7/8
24	2 1/4
30	2 3/4
36	2 5/8
42	2 1/4
48	2 1/2
54	2 7/8
60	3 1/8
64	3 3/8

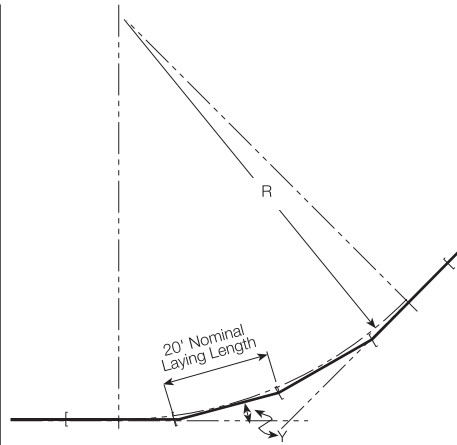
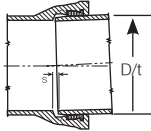

R = Radius of Curve (ft.)

Y = Deflection Angle (degrees)

$$\text{Radius of Curve} = \frac{\text{Nominal Laying Length}}{2 \times \text{Tangent}(Y \div 2)}$$

Maximum Allowable Separation, "S", in Standard Bell pipe is approximately equal to the median pipe diameter in inches times the sine of the deflection angle. This is provided for information only and should not be used to determine precise joint deflection.



AMERICAN Fastite® Joint Pipe Assembly Instructions

The AMERICAN Fastite Joint is a push-on type joint meeting all the rigorous requirements of AWWA C111. The ANSI/AWWA C600 Standard covers in detail the installation of ductile iron water mains, including assembly instructions for push-on joint pipe.

Field-cutting of AMERICAN Ductile Iron Pipe can be easily performed, thus eliminating the necessity for factory-made special lengths of Fastite pipe. The plain end of Fastite pipe cut in the field requires little or no preparation for assembly into the socket of a mechanical joint fitting. Where a cut pipe is to be assembled into a Fastite socket, the required beveling or rounding of the plain end can be easily accomplished by the use of a portable grinding wheel or other suitable apparatus. Methods of cutting ductile iron pipe are described in Section 3.

The AMERICAN Fastite Joint requires only one joint component, the rubber gasket*, which when properly installed, fits snugly in the gasket recess in the bell socket. A special lubricant supplied with the pipe is applied to the plain end and the inside surface of the gasket before assembly. The pipe end is tapered or rounded to provide self-centering of the plain end in the gasket and ease of assembly. A circumferential stripe on the plain end provides a visual indication for checking the proper insertion of the joint. The stripe, shown in the photographs illustrating assembly methods, passes fully into the bell when the plain end is fully inserted into the socket with the two lengths of pipe in straight align-

ment. Joints can then be safely deflected up to the extent shown in Table No. 2-3. In deflected joints, the stripe will typically be visible to some extent after assembly.

Easier assembly is effected if the pipe is suspended an inch or so off the bottom of the trench during the jointing operation.

The following instructions should be followed in order to properly assemble the joints and to fully realize the maximum speed and ease of assembly of the Fastite Joint:

1. Clean socket and plain end thoroughly, **removing mud, gravel, or any other matter that might cause the front of the gasket to protrude into the path of the entering spigot.**

2. Insert gasket fully into the gasket recess of the socket, large end of the gasket entering first. Gasket may be installed with one or two V-shaped folds as shown (Photo 1). After the gasket is in place at the bottom, the top of the gasket is positioned fully into the gasket recess. Gaskets and lubricant to be installed in very cold weather should be warmed first (as by storage in a heated equipment cab or pick-up, etc.) for optimum assembly.

3. Apply a thin film of regular AMERICAN Fastite Joint Lubricant to the rounded or tapered spigot end of the pipe, the immediate outside pipe surface between the stripe and the nose of the pipe (Photo 2), and also to the inside surface of the gasket. **Special AMERICAN Fastite Joint Lubricant intended specifically for underwater or very wet installations can be supplied when requested.**



Photo 1

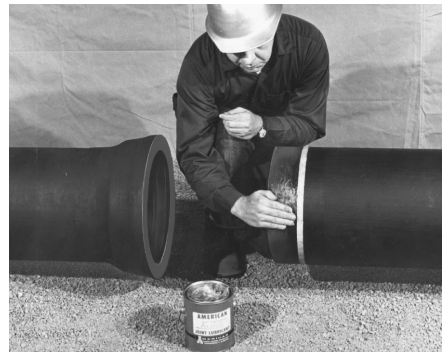

Photo 2

*Gaskets not used immediately should be stored in a cool location, out of direct sunlight.



Caution: If a spigot end contacts the ground or trench side after lubrication, any adhering dirt or rocks should be cleaned off and the area re-lubricated prior to assembly.

4. Insert the plain end in the socket. For optimum assembly it is preferable that the entering pipe be in reasonably straight alignment; however, the Fastite Joint may be assembled if necessary with the pipe deflected within its rated deflection. (Exception: If Fast-Grip gaskets are being used, straight alignment must be maintained.) Push the plain end into the socket using any of the applicable assembly methods described hereinafter. If the joint cannot be assembled with a moderate force, remove the pipe and check for the cause of the difficulty, such as improper positioning of gasket, insufficient or wrong type lubricant, dirt under or behind the gasket, dirt adhering to the pipe, or any other cause which would result in obstruction or increased friction between pipe end and

gasket surface. **For assurance of proper assembly, a thin automotive, blade-type feeler gauge can also be used if desired for quick and easy probe confirmation of correctly installed axial gasket position around the joint.**

5. "Backwards" installation. AMERICAN does not recommend "backward laying" (bells assembled over spigots, rather than spigots inserted into bells as pictured in this literature) of large-diameter ductile iron pipe in buried installations. AMERICAN can furnish bell and plain end fittings to minimize the need for backward pipe laying. Other devices such as sleeves and couplings may also be employed for this reason. However, if this condition cannot be avoided, we strongly recommend that installers contact AMERICAN for instructions on how to reduce the potential for problems that could occur when assembling pipe in this manner.

AMERICAN Pipe Assembly Mechanisms

In general, Fastite joints or other Fastite gasketed pipes may be readily pushed or pulled together without the need for complicated tools or substantial manpower. This is most often accomplished with the procedures discussed on page 2-14. In general, the joints of AMERICAN push-on pipes are purposefully "tight," and most joints require an assembly force of about 100 to 200 pounds or more of assembly force per inch of pipe diameter (i.e. a 12" joint might require about 12 x 100 or 1,200 pounds of assembly force).

In pulling operations, simply wrap a sound wire rope choker cable or nylon sling around the barrel of the entering pipe. Secure the thimble eye or other end loop of the choker to a suitably anchored pulling device (e.g. backhoe, come-along, etc.). Use the mechanism to pull the cable taut in the

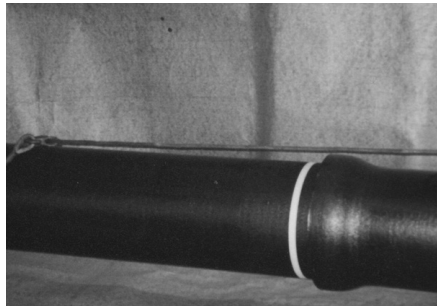

Photo 3

assembly direction (Photo 3). Continue pulling the cable in a smooth, continuous motion until the joint is in the fully assembled position. If desired for special conditions, AMERICAN can furnish suitable, simple come-alongs and choker cables for manpower assembly of

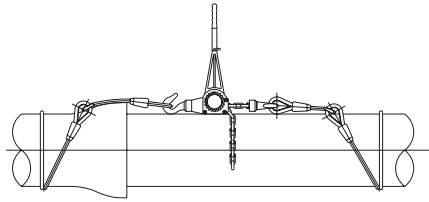

Figure 1
most 4"-24" pipes (See Figure 1 and specify pipe sizes involved).

The joints may normally be disassembled in a similar manner, reversing the direction of the pull with the choker cable (Photo 4). It is also sometimes helpful to use rebating or wiggling deflection to aid in the disassembly of push-on joint pipes, particularly when pipes have been installed for some time prior to removal.

30"-64" Pipe



Photo 4

Large pipes are most often readily pushed or pulled together with heavy excavating/earthmoving equipment available on-site (see page 2-14). In cases where assembly of pipes by manpower is desired, AMERICAN can provide special assembly tools and rigging which can be used for assembling most pipes of all sizes (Photo 5). These tools consist of a heavy-duty roller chain hoist, a steel pipe-end hook and snatch block, and associated wire



Photo 5

rope and chain tackle (Photo 5) to attach all the rigging together to effect "double line" assembly from the top of the pipe (Photo 6). The snatch block pulley and twin line rigging approximately doubles the assembly force from the strong come-along, making possible the assembly of up to 64" full-length pipe joints from the top of the pipe (Photo 7).



Photo 6

Fittings and Short Pipes

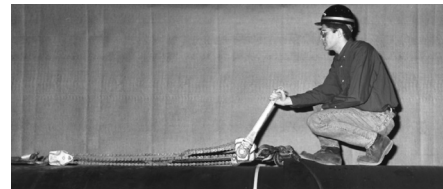

Photo 7

Push-on fitting or short pipe joint assembly is basically the same as that of standard length pipe, though special rigging may be necessary to hold these short items reasonably stable for assembly. See also Push-On Fittings Assembly Instructions in Section 4.

Field Rounding

Occasionally, field rounding of pipe ends may be necessary to accomplish assembly, particularly when large-diameter pipes are cut to be assembled into mechanical joints or couplings. Need for rounding in assembly of mechanical or stuffing-box-type joints can be predetermined by a difficulty in sliding the gland or end ring over the end of the pipe. Rounding may be accomplished in the following manner using a mechanical jack and shaped blocks. (Note: This procedure may also be used with the assemblies involving push-on joint pipe, fittings, valves, etc.; however, rounding is less frequently necessary for assembly of push-on joints.)



1. Measure/determine the minimum (minor) diameter of the ends to be rounded.
2. Place the jack and the shaped blocks in line with the minor diameter as shown in the attached sketch using a sound 4"x4" spacer timber cut square to the required length to take up the space.
3. Apply a load carefully with the jack only until the "minimum diameter equals the maximum diameter," or until the gland will easily slip over the end. No more jacking should be attempted or necessary - **DO NOT ATTEMPT TO PERMANENTLY ROUND END.**
4. When no mechanical joint restraint device is used, carefully relax and remove the jack and timbers from the pipe after joint assembly.
5. When using a mechanical joint restraint device not manufactured by AMERICAN, contact the applicable manufacturer of the restraint device regarding installation guidelines.

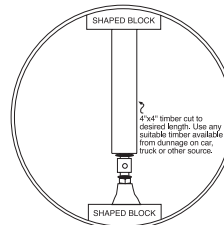

Note: Field rounding operations should be conducted without backfill on any part of large-diameter pipes and prior to encasing any part of pipe in concrete. If the inside of the pipe cannot be accessed to remove jacking materials, pipe ends can alternatively be rounded using external clamping means.

AMERICAN Fastite® Joint Lubricant Requirement by Size of Pipe



64" AMERICAN Fastite Joint pipe being installed in a wastewater application.

Table No. 2-5

Pipe Size in.	Approx. Pounds of Lubricant per Joint	Approx. No. of Joints per Pound of Lubricant
4	.03	33
6	.045	22
8	.06	17
10	.07	14
12	.08	12
14	.09	11
16	.11	9
18	.12	8
20	.14	7
24	.17	6
30	.30	3
36	.36	3
42	.44	2
48	.50	2
54	.59	2
60	.66	1
64	.71	1



AMERICAN Fastite® Joint Common Assembly Methods

In seeking ways to take even greater advantage of the cost-reducing features of the Fastite Joint, utility contractors have developed other methods of assembling this joint without special tools. The following methods are described for the information of the user, who may elect to use them at his discretion, keeping in mind that these methods may not be effective for all installations and under all field conditions.

Spade or Crowbar Method

This is applicable to the smaller sizes of AMERICAN Fastite Joint Pipe, and consists of centering the lubricated end of the entering pipe in the gasket and then pushing against the bell face of the entering pipe with a spade or crowbar driven into the ground in front of the bell face. This method requires the trench bottom to be fairly firm soil. The method may not be effective in a rocky trench or with a trench that is soft, muddy or sandy. A wooden block between the bell face and the pry bar may increase the leverage. Easier assembly is effected if the pipe is suspended an inch or so off the bottom of the trench.

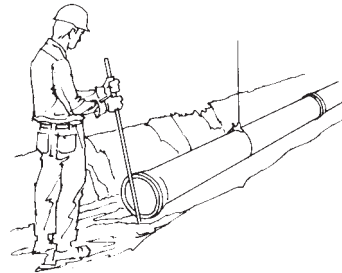

Spade or Crowbar Method

Backhoe and Heavy Equipment Methods

These methods are usually applicable to the intermediate and larger sizes of AMERICAN Fastite Joint Pipe where the bar method might not be effective. It consists of centering the end of the entering pipe in the gasket as the pipe to be assembled is suspended from the backhoe. Then it can be pulled into the adjoining socket with the pipe sling by moving the backhoe arm toward the previously assembled pipe. In other instances, the pipe may be assembled by placing the backhoe or other earth mover bucket or blade against the bell face of the entering pipe and pushing it into the socket. When pushing against the bell face, care should be taken to avoid very small contact areas and possible damage to the pipe bells or spigots. Wood cushions between the backhoe bucket and the pipe are particularly effective in preventing damage.

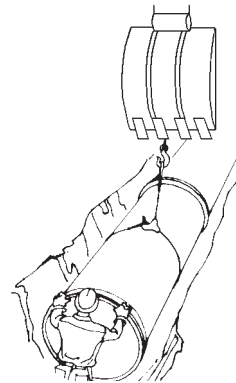

Backhoe and Heavy Equipment Methods



AMERICAN Fastite® Conductive Joints Fastite Conductive Gaskets

For cold climates where electrical thawing of service connections is required, metal contact strips are molded into the Fastite gasket, providing a “built-in” contact which will carry the necessary current between the socket and the pipe end. Under compression, the rubber gasket forces the contact strips firmly against the metal surfaces. This design assures an enclosed and protected contact which remains effective against expansion, contraction or future movement of the joint. Special preparation of the pipe sockets and plain ends is required when using conductive gaskets. Instructions are outlined on each can of AMERICAN Fastite Joint Lubricant. The Fastite Joint Conductive Gasket is satisfactory for transmission of electrical current up to 600 amps.

Other types of joint bonding are used to provide electrical conductivity across joints for low voltage/current requirements, such as for corrosion monitoring or cathodic protection.

In assembling Fastite pipe with conductive gaskets, both plain end and socket must be thoroughly cleaned and be free of rust and from asphaltic or other coating material. A protective coating is applied to the sockets and beveled ends of Fastite Conductive Joint pipe prior to shipment to prevent oxidation on the gasket seating surfaces during transportation and storage prior to assembly. Thorough cleaning of the gasket seating surfaces in the socket and on the plain end is required prior to assembly to provide proper electrical contact between the copper clips and the metallic surfaces of the joint.

Assembly from this point is the same as described previously for the Fastite Joint.

Note: Fastite Conductive Gaskets should not be used with Fastite restrained plugs. Some sizes of Fastite pipes may not be suitable for use with Conductive Gaskets – contact AMERICAN to check availability.

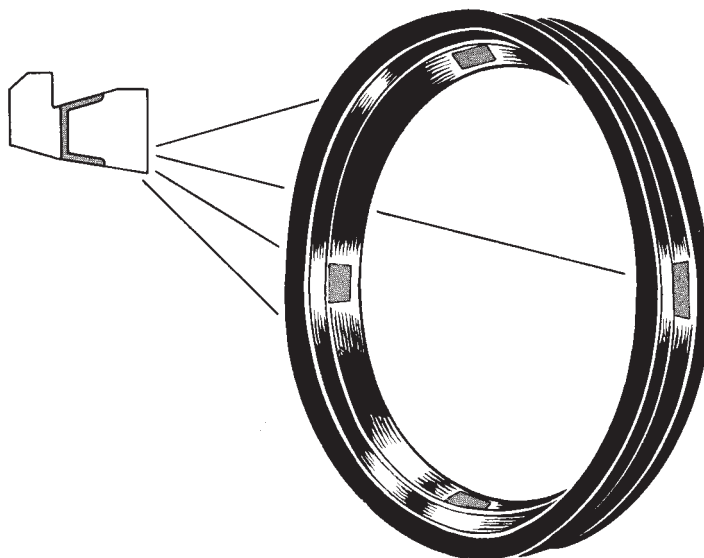

Fastite Conductive Gasket



AMERICAN DUCTILE IRON PIPE

AMERICAN Mechanical Joint Pipe For Water, Sewage or Other Liquids

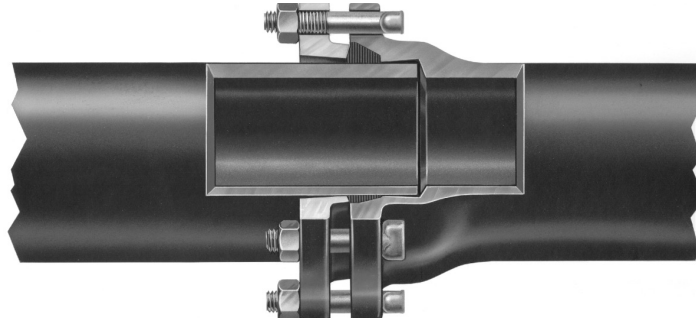

The AMERICAN Mechanical Joint was developed by the American Cast Iron Pipe Company and first marketed in 1929. Since that time, millions of feet of AMERICAN pipe equipped with this joint have been installed to give dependable service across the nation and in many foreign countries. The joint is designed with a stuffing box into which a rubber gasket is compressed by a ductile iron gland drawn up with low-alloy steel bolts. It affords liberal deflection and allows expansion and contraction of the line without leakage. It is rated for a water working pressure of up to 350 psi.

Originally designed to meet the rigid requirements of the gas industry for a pressure-tight joint, the AMERICAN Mechanical Joint was instrumental in starting a nationwide trend toward rubber-packed joints for water service as well as gas service. Its design was widely accepted and it soon became the standardized mechanical joint of the cast iron pipe industry. The popularity of the AMERICAN Mechanical

Joint among utility officials, contractors and engineers steadily increased until the majority of cast iron piping furnished for gas, water, sewage and other services was equipped with this joint. However, push-on joint pipes, which are less labor intensive and reliant with push-on or mechanical joint fittings, currently make up the vast majority of ductile iron pipelines being installed for underground service. Mechanical joint pipe is now used to a much lesser extent.

The AMERICAN Mechanical Joint meets the requirements of ANSI/AWWA C110/A21.10 and ANSI/AWWA C111/A21.11.

AMERICAN Ductile Iron Mechanical Joint Pipe is centrifugally cast in nominal 18' or 20' laying lengths, depending on size, under rigid production and quality control procedures in accordance with ANSI/AWWA Standards. AMERICAN Mechanical Joint Ductile Iron Pipe is available in 4" -12" sizes and in Special Thickness Classes 53 and higher.



The AMERICAN Mechanical Joint provides easy installation under the most adverse conditions. Plain rubber gaskets of SBR are normally used for water and domestic sewage service. Fabric tipped plain rubber gaskets are available, as well as other special gaskets such as oil-resistant rubber. Plain rubber gaskets or tipped gaskets are used for air or liquid temperatures up to 120°F. For applications involving temperatures in excess of 120°F, or for other spe-

cial service applications, and for installations in contaminated soils where permeation through gaskets might be a concern, consult AMERICAN for recommendations. See Table No. 2-6.

Standard joint accessories furnished with mechanical joint pipe and fittings include ductile iron glands, low-alloy steel tee head bolts with hex nuts and plain rubber gaskets. The cost of these accessories is normally included in the price of the pipe or fittings.

Mechanical Joint Gaskets

Table No. 2-6

Common Name or Trade Name*	Chemical Name	Maximum Service Temperature**		Common Uses
		Water & Sewer	Air	
Plain Rubber	Styrene Butadiene Copolymer(SBR)	150°F	125°F	Fresh Water, Salt Water, Sanitary Sewage
Neoprene	Polychloroprene(CR)	200°F	150°F	Fresh Water, Sewage
Fluoroelastomer Fluorel Viton®***	FKM	212°F	300°F	Aromatic Hydrocarbons, Gasoline, Refined Petroleum Products, most Chemicals and Solvents, High Temp., Air (Least permeable of all available Fastite gasket rubbers)
Buna-N Nitrile	Acrylonitrile Butadiene(NBR)	150°F	125°F	Non-Aromatic Hydrocarbons, Petroleum Oil, Hydraulic Fluids, Fuel Oil, Fats, Oil, Grease†
EPDM	Ethylene Propylene Diene Monomer	212°F	150°F	Water, Sewage, Ketones, Dilute Acids and Alkalies, Vegetable Oil, Alcohols, Air

*AMERICAN reserves the right to furnish any Trade or Brand rubber for the chemical formulation specified.

Temperature is in reference to conveyed fluid. **Lubricating oil in air can adversely affect SBR and EPDM performance. SBR, Nitrile and Neoprene are not recommended for hot air exposure in wastewater treatment systems.

Gaskets shown for use in "Sanitary Sewage" service are also suitable for use with sewage gas.

Refer to Section 11 for temperature and service capabilities of pipe linings.

Refer other special requirements to AMERICAN for recommendation regarding suitable gasket material.

***Viton® is a registered trademark of DuPont Dow Elastomers.

Note that temperature ratings of MJ gaskets per Table No. 2-6 are in some cases lower than the ratings for similar material Fastite gaskets (see Table No. 2-1, pg. 2-7). The designer may wish to consider the use of Fastite pipe and fittings in high-temperature applications.

All MJ gaskets made from the materials in the above table are suitable for use with water containing normal concentrations of chloramine. Where increased resistance to chloramine is desired, neoprene or fluoroelastomer materials should be considered.

†This gasket rubber is **chemically resistant** for the non-potable water uses shown, but NBR is not as resistant to permeation in potable water applications as FKM.



American Mechanical Joint
ANSI/AWWA C111/A21.11 Standard Dimensions

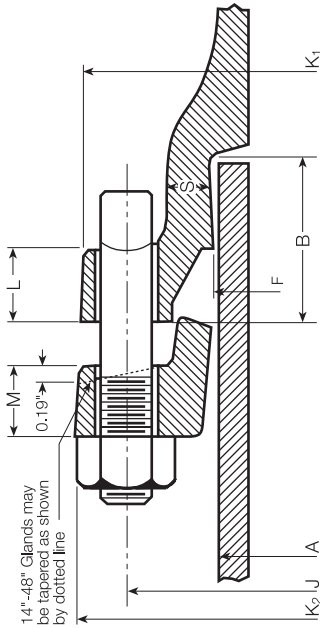

Table No. 2-7

Size in.	Dimensions in Inches											
	A Plain End	B	F	J	K ₁		K ₂	L		M	S	
					Centrifugal Pipe	Fittings		Centrifugal Pipe	Fittings		Centrifugal Pipe	Fittings
* 2	2.50	2.50	2.61	4.75	6.00	6.25	6.25	.56	.75	.62	.37	.44
* 2 1/4	2.75	2.50	2.86	5.00	6.25	6.50	6.50	.56	.75	.62	.37	.44
* 3	3.96	2.50	4.06	6.19	7.62	7.69	7.69	.87	.94	.62	.40	.52
4	4.80	2.50	4.90	7.50	9.06	9.38	9.12	.91	1.00	.75	.41	.65
6	6.90	2.50	7.00	9.50	11.06	11.31	11.12	.94	1.06	.88	.43	.70
8	9.05	2.50	9.15	11.75	13.31	13.63	13.37	.98	1.12	1.00	.45	.75
10	11.10	2.50	11.20	14.00	15.62	15.81	15.62	.98	1.19	1.00	.47	.80
12	13.20	2.50	13.30	16.25	17.88	18.06	17.88	.98	1.25	1.00	.49	.85
14	15.30	3.50	15.44	18.75	20.25	20.69	20.25	1.02	1.31	1.25	.51	.89
16	17.40	3.50	17.54	21.00	22.50	22.94	22.50	1.08	1.38	1.31	.52	.97
18	19.50	3.50	19.64	23.25	24.75	25.28	24.75	1.14	1.44	1.38	.53	1.05
20	21.60	3.50	21.74	25.50	27.00	27.08	27.00	1.20	1.50	1.44	.54	1.12
24	25.80	3.50	25.94	30.00	31.50	31.75	31.50	1.26	1.62	1.56	.56	1.22
30	32.00	4.00	32.17	36.88	**	39.12	39.12	**	1.81	2.00	**	1.50
36	38.30	4.00	38.47	43.75	**	46.00	46.00	**	2.00	2.00	**	1.80
42	44.50	4.00	44.67	50.62	**	53.12	53.12	**	2.00	2.00	**	1.95
48	50.80	4.00	50.97	57.50	**	60.00	60.00	**	2.00	2.00	**	2.20

*2", 2 1/4" and 3" sizes of pipe are no longer manufactured by AMERICAN and dimensions are given for information only. 2" and 2 1/4" sizes are not shown in AWWA C111.
 **1.4"-48" Mechanical Joints are not available on centrifugal pipe.
 The ductile iron pipe bell flanges are in accordance with AWWA C111 which also provides that thicker bell flanges may be furnished.
 For additional information and tolerances see AWWA C111.
 Bolt Holes are 1/8" larger than the bolt diameters. See Table No. 2-8.
 Weights and classes for ductile iron pipe are given in Section 3.



AMERICAN Mechanical Joint Accessories

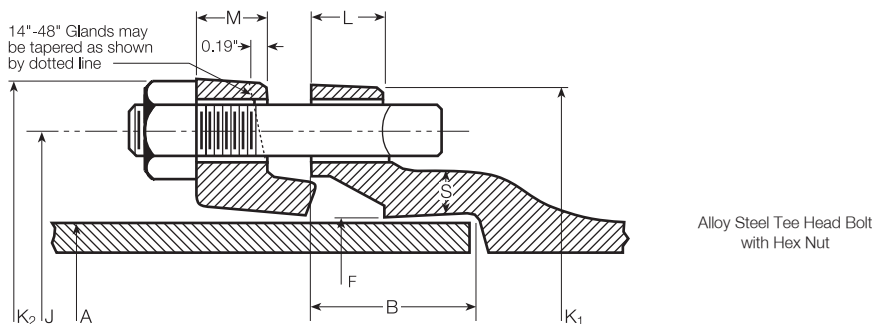

Table No. 2-8

Size in.	Bolts		Weight in Pounds			
	No. Per Joint	Size in.	Bolts Total	Gland	Gasket†	One Set Accessories
4	4	3/4 x 3 1/2	3	6	.42	10
6	6	3/4 x 3 1/2	5	11	.59	17
8	6	3/4 x 4	5	18	.75	24
10	8	3/4 x 4	7	20	.92	28
12	8	3/4 x 4	7	30	1.09	39
14	10	3/4 x 4 1/2	9	35	1.23	46
16	12	3/4 x 4 1/2	11	45	1.42	58
18	12	3/4 x 4 1/2	11	55	1.56	68
20	14	3/4 x 4 1/2	13	70	1.77	85
24	16	3/4 x 5	15	90	2.13	108
30*	20	1 x 6	41	180	4.16	225
36*	24	1 x 6	49	235	4.81	289
42*	28	1 1/4 x 6 1/2	99	300	5.77	405
48*	32	1 1/4 x 6 1/2	113	365	6.52	485
54**	36	1 1/4 x 6 1/2	127	360	7.30	494

AMERICAN no longer manufactures 2", 2 1/4" and 3" sizes of pipe; bolts required per joint for 2" and 2 1/4" sizes were 2 5/8" x 2 1/2", and for 3" size were 4 5/8" x 3".

Bolts used with mechanical joint retainer glands may be required by the manufacturers of those devices to be longer than shown above.

When required and when used with bell flanges "tapped for studs," stud bolts in lieu of Tee Head bolts are normally ordered of the same length of the Tee Head bolts they replace (See pages 2-24 and 2-25).

†Gasket weights shown here are for standard SBR rubber; other available rubber types are shown on page 2-17.

**14"-48" mechanical joints are for fittings only.

**54" Mechanical Joints are used only with special mechanical joint sleeves. This size is not in AWWA C110.



**AMERICAN Mechanical Joint Pipe
Allowable Joint Deflection**

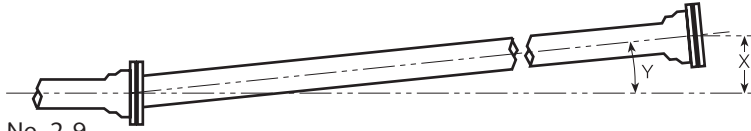

Table No. 2-9

Size in.	Nominal Laying Length ft.	Maximum Recommended Deflection		
		X Offset per Nominal Length in.	Y Deflection Angle	Radius of Curve* ft.
4	18	31	8°-18'	124
6	20	30	7°-07'	160
8	20	22	5°-21'	220
10	20	22	5°-21'	220
12	20	22	5°-21'	220
14	**	**	3°-35'	**
16	**	**	3°-35'	**
18	**	**	3°-00'	**
20	**	**	3°-00'	**
24	**	**	2°-23'	**
30	**	**	2°-23'	**
36	**	**	2°-05'	**
42	**	**	2°-00'	**
48	**	**	2°-00'	**

*Approximate radius of curve produced by a succession of nominal lengths of pipe fully deflected. A shorter radius can be obtained using shorter pipes.

The joint should be assembled with the pipe in reasonably straight alignment. Joint deflection to the maximum shown above may be made after assembly but before tightening bolts. Offset distances are based on 18-ft or 20-ft lengths.

**14"-48" Mechanical Joints are provided on fittings and valves only.

Maximum Allowable Separation

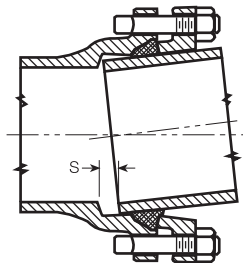
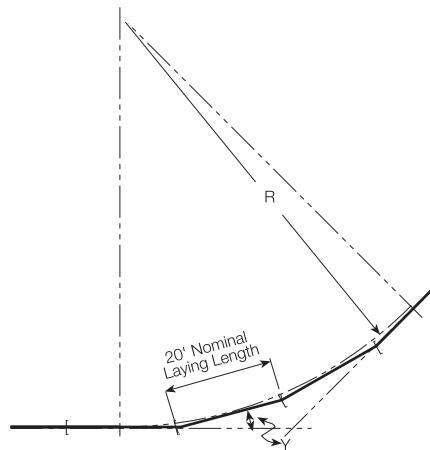

Table No. 2-10

Size in.	S Separation in.
24	1
30	1 1/4
36	1 3/8
42	1 1/2
48	1 3/4

Maximum Allowable Separation, "S", is provided for information only and should not be used to determine precise joint deflection.



R = Radius of Curve (ft.)

Y = Deflection Angle (degrees)

$$\text{Radius of Curve} = \frac{\text{Nominal Laying Length}}{2 \times \text{Tangent } (Y/2)}$$



**AMERICAN Mechanical Joint Pipe
Assembly Instructions**

The AMERICAN Mechanical Joint is the Standardized Mechanical Joint per AWWA C111. Assembly of the Mechanical Joint is pictured and described below.

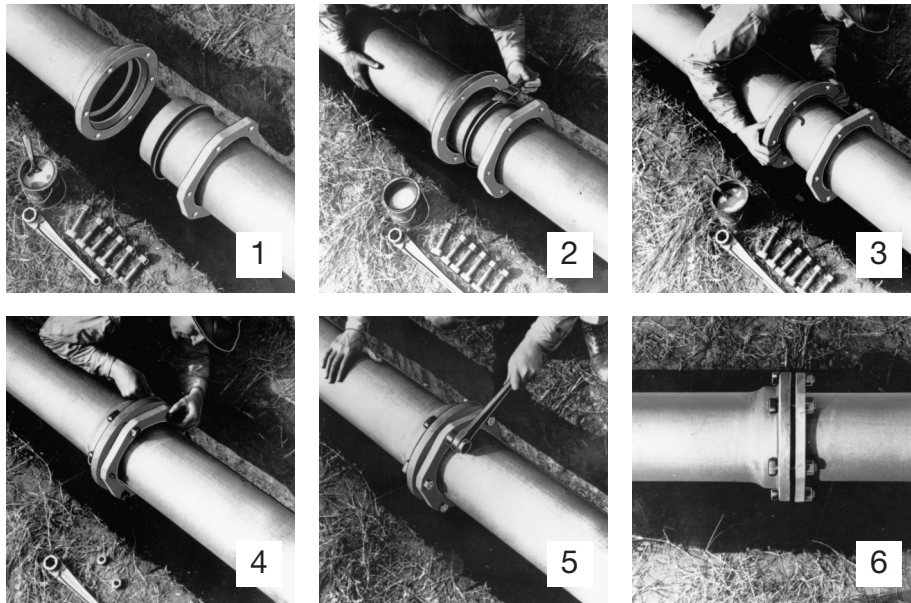

1. Thoroughly clean socket and plain end of all rust or foreign material; slip the gland over plain end with the lip extension toward plain end, followed by the gasket with thick section facing the gland. Gaskets to be installed during very cold weather should be warmed first.*

2. **Lubricate** socket, gasket and plain end with soapy water or an approved pipe lubricant meeting requirements of AWWA C111.

3. Insert plain end into socket and push gasket into position, making sure it is evenly seated in socket.

4. Slide gland into position, insert bolts and run nuts up finger-tight.

5. Tighten bolts to draw gland toward the pipe flange evenly, maintaining approximately the same distance between the gland and the face of the flange at all points around the joint. This may be achieved by partially tightening the bottom bolt first; then the top bolt; next, the bolts at either side; and, finally, the remaining bolts. This process should be repeated un-

til all bolts are within the range of torques shown. **In larger sizes (30"-48")**, as many as 5 or more repetitions may be required.

6. The completed joint.

It is recommended that the torque be applied with torque-measuring wrenches. The approximate torque can be applied by a man trained to give an average pull on a specific length regular ratchet wrench; for 5/8" bolt, length of wrench is 8"; for 3/4" bolt, 10"; for 1" bolt, 14"; and for 1 1/4" bolt, 16". **Torque so applied should be checked with torque-measuring wrenches. *Gaskets not used immediately should be stored in a cool location, out of direct sunlight.**

Table No. 2-11

Pipe Size† in.	Bolt Diameter in.	Range of Torque Ft.-Lbs
4-24	3/4	75-90
30-36	1	100-120
42-48	1 1/4	120-150

† 14"-48" Mechanical Joints are provided on fittings and valves only.



AMERICAN Grooved and Shouldered Joints
AMERICAN Grooved Joint
AWWA C606

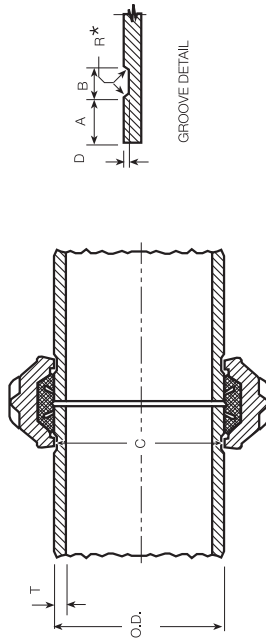

Table No. 2-12

Size in.	Dimensions in Inches										Weight in Pounds	
	O.D.	T** Nominal Wall Thickness	Coupling Max. Working Pressure† psi	A		B	C	D Groove Depth		Min. Length Grooved End Pipe in.	Per Foot (Without Coupling)	Per Maximum†† Length
				Flexible Joint	Rigid Joint			Min.	Max.			
4	4.80	.32	500	.750	.840	.375	4.563	.096	.151	3 1/2	13.8	241
6	6.90	.34	400	.750	.840	.375	6.656	.100	.154	3 1/2	21.4	430
8	9.05	.36	400	.875	.950	.500	8.781	.104	.177	4	30.1	600
10	11.10	.38	350	.938	1.015	.500	10.813	.114	.186	4	39.2	785
12	13.20	.40	350	.938	1.015	.500	12.906	.117	.192	4	49.2	985
14	15.30	.42	250	.938	1.015	.625	14.969	.126	.206	4 1/4	60.1	1200
16	17.40	.43	250	1.188	1.340	.625	17.063	.128	.208	5	70.1	1410
18	19.50	.44	250	1.188	1.340	.625	19.125	.148	.228	5	80.6	1610
20	21.60	.45	150	1.188	1.340	.625	21.219	.150	.230	5	91.5	1830
24	25.80	.47	150	1.188	1.340	.625	25.406	.157	.237	5	114.4	2290
30†††	32.00	.51	150	1.375	1.625	.750	31.550	.195	—	6	154.4	3010
36†††	38.30	.58	150	1.375	1.625	.750	37.850	.195	—	6	210.3	4100

**R* for sizes 4" and 6" is .120"; for 8"-12" is .145"; for 14" and 16" is .165"; for 18"-24" is .185"; and for 30" and 36" is .215".
 **Minimum nominal wall thickness of centrifugally cast ductile iron pipe furnished with Grooved Joint. Thicknesses above correspond to Special Thickness Class 53 for all sizes.
 †Pressure ratings established by coupling manufacturer.
 ††Maximum length for 4" size is 17'6", for 6"-24" sizes is 20'0", and for 30"-36" sizes is 19'6".
 †††Shorter lengths than the maximum lengths can, of course, be furnished.
 †††30" and 36" sizes are not included in AWWA C606.

For tolerances see AWWA C606.
 Standard fittings are available with Grooved Joints and are normally available only with rigid grooving.
 Couplings for Grooved Joints may be furnished by AMERICAN but are not of our design or manufacture. Check AMERICAN for details and recommendations.



AMERICAN Shouldered Joint*
AWWA C606

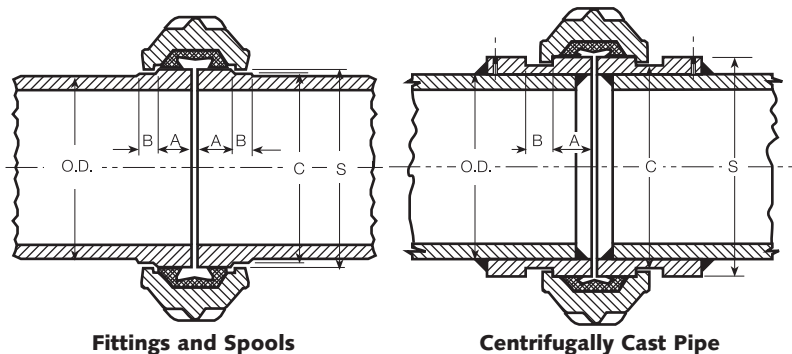

Table No. 2-13

Size in.	Dimensions in Inches					Coupling Max. Working Pressure**
	O.D.	A	B Min.	C Max	S	
18	19.50	1.188	.750	20.469	20.937	175
20	21.60	1.188	.750	22.344	22.875	175
24	25.80	1.188	.750	26.594	27.125	175
30	32.00	1.750	1.000	33.000	33.750	175
36	38.30	1.750	1.000	39.438	40.188	175
42	44.50	1.750	1.250	45.813	46.625	175
48	50.80	1.750	1.250	52.188	53.125	175
54	57.56	1.750	1.500	58.625	59.688	175
60	61.61	1.750	1.500	63.625	64.688	90
60	61.61	1.750	1.500	65.063	66.188	175
64†	65.67	1.750	1.500	69.625	70.750	90

*AMERICAN Shouldered Joints are furnished on fittings and on statically cast pipe as shown left above. On centrifugally cast pipe the Shouldered Joint is furnished with welded steel end ring fabricated as shown right above. Consult AMERICAN regarding specific requirements.

Wall thickness will vary according to service requirements and with method of casting—centrifugal or static.

Shouldered Joints with other dimensions can be furnished under certain circumstances. Check AMERICAN for details.

Couplings for Shouldered Joints are not designed or manufactured by AMERICAN, but may be furnished on request. Check AMERICAN for recommendations.

**Pressure rating established by coupling manufacturer.

†66" couplings are used with 64" pipe.

Welded rings can be furnished on minimum pressure classes of ductile iron pipe. Maximum laying length is 19'6" and minimum laying length is 1'6" for all sizes.

Check AMERICAN if smaller sizes of shouldered end pipes are desired.



**AMERICAN Bolted Joints
Tee Head Bolts**

Table No. 2-14

Pipe Size in.	Mechanical Joint		Mechanical Joint with Retainer Gland		MJ Coupled Joint	
	No.	Size in.	No.	Size in.	No.	Size in.
4	4	3/4x3 1/2	4	3/4x3 1/2	4	3/4x4
6	6	3/4x3 1/2	6	3/4x4	6	3/4x4
8	6	3/4x4	6	3/4x4 1/2	6	3/4x4 1/2
10	8	3/4x4	8	3/4x4 1/2	8	3/4x4 1/2
12	8	3/4x4	8	3/4x4 1/2	8	3/4x4 1/2
14	10	3/4x4	10	3/4x5	10	3/4x5
16	12	3/4x4 1/2	12	3/4x5	12	3/4x5
18	12	3/4x4 1/2	12	3/4x5	12	3/4x5
20	14	3/4x4 1/2	14	3/4x5	14	3/4x5 1/2
24	16	3/4x5	16	3/4x5 1/2	16	3/4x5 1/2
30*	20	1 x6	-	-	20	1 x7
36*	24	1 x6	-	-	24	1 x7
42*	28	1 1/4x6 1/2	-	-	28	1 1/4x7
48*	32	1 1/4x6 1/2	-	-	32	1 1/4x7

*14"-48" Mechanical Joints are furnished on fittings only.

Boxing of Tee Head Bolts†

Tee Head Bolts with Hex Nuts are boxed with the following number per box (per each weight of bolt and nut shown in parentheses):

5/8 x 3	(.48)-375	3/4 x 6 1/2	(1.11)-125	1 x 9 1/2	(3.00)-50	} Boxed per order
3/4 x 3 1/2	(.80)-225	3/4 x 7	(1.16)-100	1 1/4 x 6	(3.40)-50	
3/4 x 4	(.85)-200	3/4 x 8	(1.33)-75	1 1/4 x 8 1/2	(4.25)-40	
3/4 x 4 1/2	(.91)-175	1 x 5	(1.86)-100	†† 1 1/4 x 13 1/2	(6.25)	
3/4 x 5	(.96)-175	1 x 6	(2.06)-75	1/2 x 8 1/2	(6.75)	
3/4 x 5 1/2	(1.01)-150	1 x 7	(2.26)-75	1/2 x 10	(7.65)	
3/4 x 6	(1.06)-150	1 x 7 1/2	(2.36)-75	1/2 x 11	(8.25)	

†Bolts and nuts of special sizes not routinely furnished by AMERICAN are also shown for information.

††Double nut stud, 4 1/2" minimum thread one end, 2" on other end.

Approximate unit weights, in pounds, of nuts only are as follows: 5/8"-.12; 3/4"-.19; 1"-.42; 1 1/4"-.80; 1 1/2"-1.40.

Bolts for 4"-48" MJ Joints are per AWWA C111.



AMERICAN Tee Head Bolts, Studs and Nuts Alloy Steel

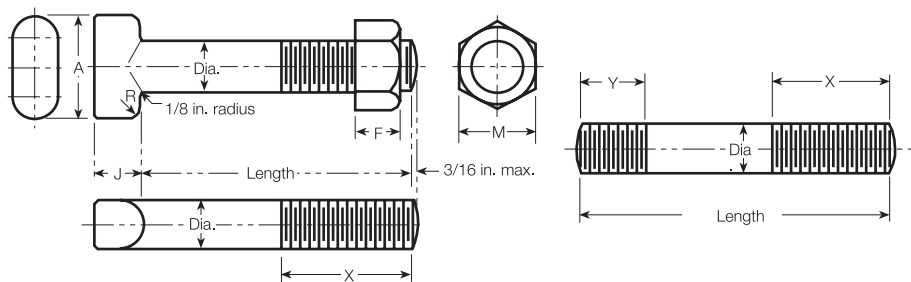

Tee Head Bolt

Stud Bolt

Table No. 2-15

Tee Head Bolts and Stud Bolts			Dimensions in Inches						
Diameter in.	Length in.	No. of Threads Per Inch	A	F	H	J	R Max.	X	Y*
3/4	3 1/2	10	1.75	.750	1.250	.750	.375	2.50	1.00
3/4	4	10	1.75	.750	1.250	.750	.375	3.00	1.00
3/4	4 1/2	10	1.75	.750	1.250	.750	.375	3.00	1.31
3/4	5	10	1.75	.750	1.250	.750	.375	3.00	1.63
3/4	5 1/2	10	1.75	.750	1.250	.750	.375	3.00	1.63
1	6	8	2.25	1.000	1.625	1.000	.500	3.00	1.75
1	7	8	2.25	1.000	1.625	1.000	.500	4.00	2.00
1 1/4	6	7	2.50	1.250	2.000	1.250	.625	3.00	2.00
1 1/4	6 1/2	7	2.50	1.250	2.000	1.250	.625	3.50	2.00
1 1/4	7	7	2.50	1.250	2.000	1.250	.625	4.00	2.00
1 1/4	8 1/4	7	2.50	1.250	2.000	1.250	.625	4.50	2.00

*The "Y" Dimension is only applicable for standard mechanical joints.

All threads are Coarse-Thread Series Class 2A, External and Class 2B, Internal, per ANSI B1.1.

Threads are the same for bolts and studs.

For tolerances see AWWA C111.

Stud bolts with one nut are furnished when specified in lieu of Tee Head bolts, with the required Stud Bolt length normally equal to the length of the Tee Head bolt it replaces.

Nuts are furnished in accordance with ASTM A563, Standard Specification for Carbon and Alloy Steel Nuts.



AMERICAN DUCTILE IRON PIPE

AMERICAN reserves the right to modify or change designs, materials, specifications, or dimensions shown herein without prior notice.

*This is a preprint of a section from the 19th Edition of the AMERICAN Pipe Manual.
References may be made in this section to other sections of this manual.*